

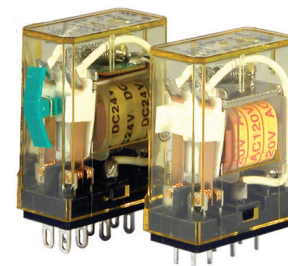

## RY/RM Series Miniature Relays

### Key features:

- RY2 (3A), RY4 (5A), RM2 (5A)
- General purpose miniature relays
- 3A or 5A contact capacity
- Wide variety of terminal styles and coil voltages meet a wide range of applications
- All 4PDT types have arc barriers.

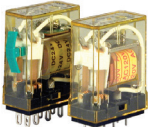

### Part Number Selection

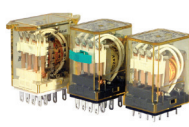
Contact	Model	Part Number		Coil Voltage Code
		Plug-in Terminal	PC Board Terminal	
 DPDT (Slim) 3A	Standard	RY2S-U □	RY2V-U □	AC6V, AC12V, AC24V, AC110V, AC120V, AC220V, AC240V DC6V, DC12V, DC24V, DC48V, DC110V
	With Indicator	RY2S-UL □	RY2V-UL □	
	With Check Button	RY2S-UC □	—	
	With Indicator and Check Button	RY2S-ULC □	—	
	Top Bracket Mounting	RY2S-UT □	—	
	With Diode (DC coil only)	RY2S-UD □	RY2V-UD □	
 DPDT (Wide) 5A	Standard	RM2S-U □	RM2V-U □	RYAC6V, AC12V, AC24V, AC110-120V, AC220-240V DC6V, DC12V, DC24V, DC48V, DC100-110V
	With Indicator	RM2S-UL □	RM2V-UL □	
	With Check Button	RM2S-UC □	—	
	With Indicator and Check Button	RM2S-ULC □	—	
	Top Bracket Mounting	RM2S-UT □	—	
	With Diode (DC coil only)	RM2S-UD □	—	
 4PDT 5A	Standard	RY4S-U □	RY4V-U □	AC6V, AC12V, AC24V, AC110-120V, AC220-240V DC6V, DC12V, DC24V, DC48V, DC100-110V
	With Indicator	RY4S-UL □	RY4V-UL □	
	With Check Button	RY4S-UC □	—	
	With Indicator and Check Button	RY4S-ULC □	—	
	Top Bracket Mounting	RY4S-UT □	—	
	With Diode (DC coil only)	RY4S-UD □	—	
	With Indicator and Diode (DC coil only)	RY4S-ULD □	—	DC6V, DC12V, DC24V, DC48V, DC100-110V



Top mount models are designed to mount directly to a panel and do not require a socket.

#### Ordering Information

When ordering, specify the Part No. and coil voltage code:

(example) **RY4S-U** **AC110-120V**  
 Part No.                      Coil Voltage Code

Switches & Pilot Lights

Signaling Lights

Relays & Sockets

Timers





Contactors

Terminal Blocks

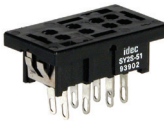

Circuit Breakers

Sockets

Relays	Standard DIN Rail Mount	Finger-safe DIN Rail Mount	Through Panel Mount	PCB Mount
RY2S	SY2S-05	SY2S-05C	SY2S-51	SY2S-61
RM2	SM2S-05	SM2S-05C	SM2S-51	SY4S-61 SY4S-62
RY4S	SY4S-05	SY4S-05C	SY4S-51	









Hold Down Springs & Clips

Appearance	Item	Relay	For DIN Mount Socket	For Through Panel & PCB Mount Socket
	Pullover Wire Spring	RY2S	SY2S-02F1	SY4S-51F1
		RM2	SY4S-51F1	SY4S-51F1
		RY4S		
	Leaf Spring <sup>1</sup> (side latch)	RY2S	SFA-202 <sup>2</sup>	SFA-302
		RM2, RY4S		
	Leaf Spring <sup>1</sup> (top latch)	RY2S	SFA-101 <sup>2</sup>	SFA-301
		RM2		
		RY4S		

-  1. Not available for PCB mount socket SY4S-62.
- 2. Order 2 pieces per relay.

Accessories

Item	Appearance	Use with	Part No.	Remarks
Aluminum DIN Rail (1 meter length)		All DIN rail sockets	BNDN1000	The BNDN1000 is designed to accommodate DIN mount sockets. Made of durable extruded aluminum, the BNDN1000 measures 0.413 (10.5mm) in height and 1.37 (35mm) in width (DIN standard). Standard length is 39" (1,000mm).
DIN Rail End Stop		DIN rail	BNL5	9.1 mm wide.
Replacement Hold-Down Spring Anchor		Horseshoe clip for all DIN rail sockets	Y778-011	For use on DIN rail mount socket when using pullover wire hold down spring. 2 pieces included with each socket.

## Specifications

Contact Model	Standard Contact		
	RY2 - DPDT Slim	RM2 - DPDT Wide	RY4 - 4PDT
Contact Material	Gold-plated silver	Silver	Gold-plated silver
Contact Resistance <sup>1</sup>	50 mΩ maximum	30 mΩ maximum	50 mΩ maximum
Minimum Applicable Load	24V DC, 5 mA; 5V DC, 10 mA (reference value)	24V DC, 10 mA; 5V DC, 20 mA (reference value)	24V DC, 5 mA; 5V DC, 10 mA (reference value)
Operating Time <sup>2</sup>	20 ms maximum		
Release Time <sup>2</sup>	20 ms maximum		
Power Consumption (approx.)	AC: 1.1 VA (50 Hz), 1 VA (60 Hz) DC: 0.8W	AC: 1.4 VA (50 Hz), 1.2 VA (60 Hz) DC: 0.9W	AC: 1.4 VA (50 Hz), 1.2 VA (60 Hz) DC: 0.9W
Insulation Resistance	100 MΩ minimum (500V DC megger)		
Dielectric Strength	Between live and dead parts:		
	1500V AC, 1 minute	2000V AC, 1 minute	2000V AC, 1 minute
	Between contact and coil:		
	1500V AC, 1 minute	2000V AC, 1 minute	2000V AC, 1 minute
	Between contacts of different poles:		
	1500V AC, 1 minute	2000V AC, 1 minute	2000V AC, 1 minute
Dielectric Strength	Between contacts of the same pole:		
	1000V AC, 1 minute	1000V AC, 1 minute	1000V AC, 1 minute
Operating Frequency	Electrical: 1800 operations/h maximum Mechanical: 18,000 operations/h maximum		
Vibration Resistance	Damage limits: 10 to 55 Hz, amplitude 0.5 mm Operating extremes: 10 to 55 Hz, amplitude 0.5 mm		
Shock Resistance	Damage limits: 1000 m/s <sup>2</sup> Operating extremes: 100 m/s <sup>2</sup> (DPDT Slim), 200 m/s <sup>2</sup> (4PDT, DPDT Wide)		
Mechanical Life	50,000,000 operations		
Electrical Life	200,000 operations (220V AC, 3A)	500,000 operations (220V AC, 5A)	100,000 operations (220V AC, 5A) 200,000 operations (220V AC, 3A)
Operating Temperature <sup>3</sup>	-25 to +55°C (no freezing)	-25 to +45°C (no freezing)	-25 to +55°C (no freezing) <sup>4</sup>
Operating Humidity	45 to 85% RH (no condensation)		
Weight (approx.)	23g	35g	34g



Note: Above values are initial values.

1. Measured using 5V DC, 1A voltage drop method
2. Measured at the rated voltage (at 20°C), excluding contact bouncing  
Release time of relays with diode: 40 ms maximum

3. For use under different temperature conditions, refer to Continuous Load Current vs. Operating Temperature Curve. The operating temperature range of relays with indicator or diode is -25 to +40°C.
4. When the total current of 4 contacts is less than 15A, the operating temperature range is -25 to +70°C.

Switches & Pilot Lights

Signaling Lights

**AC Coil Ratings**

Voltage (V)	Rated Current (mA) ±15% at 20°C				Coil Resistance (Ω) ±10% at 20°C		Operation Characteristics (against rated values at 20°C)		
	AC 50Hz		AC 60Hz						
	DPDT Slim	DPDT Wide & 4PDT	DPDT Slim	DPDT Wide & 4PDT	DPDT Slim	DPDT Wide & 4PDT	Max. Continuous Applied Voltage	Pickup Voltage	Dropout Voltage
6	170	240	150	200	18.8	9.4	110%	80% maximum	30% minimum
12	86	121	75	100	76.8	39.3			
24	42	60.5	37	50	300	153			
110	9.6	—	8.4	—	6,950	—			
110-120	—	9.4-10.8	—	8.0-9.2	—	4,290			
120	8.6	—	7.5	—	8,100	—			
220	4.7	—	4.1	—	25,892	—			
220-240	—	4.7-5.4	—	4.0-4.6	—	18,820			
240	4.9	—	4.3	—	26,710	—			

Relays & Sockets

Timers

**DC Coil Ratings**

Voltage (V)	Rated Current (mA) ±15% at 20°C		Coil Resistance (Ω) ±10% at 20°C		Operation Characteristics (against rated values at 20°C)		
	DPDT Slim	DPDT Wide & 4PDT	DPDT Slim	DPDT Wide & 4PDT	Max. Continuous Applied Voltage	Pickup Voltage	Dropout Voltage
6	128	150	47	40	110%	80% maximum	10% minimum
12	64	75	188	160			
24	32	36.9	750	650			
48	18	18.5	2,660	2,600			
100-110	—	8.2-9.0	—	12,250			
110	8	—	13,800	—			

**Contact Ratings**

Maximum Contact Capacity						
Contact	Continuous Current	Allowable Contact Power		Rated Load		
		Resistive Load	Inductive Load	Voltage (V)	Res. Load	Ind. Load
DPDT Slim (RY2)	3A	660 VA AC 90W DC	176 VA AC 45W DC	110V AC	3A	1.5A
				220V AC	3A	0.8A
				30V DC	3A	1.5A
DPDT Wide (RM2)	5A	1100VA AC 150W DC	440VA AC 75W DC	110V AC	5A	2.5A
				220V AC	5A	2A
				30V DC	5A	2.5A
4PDT (RY4)	5A	1200 VA AC 150W DC	288 VA AC 60W DC	240V AC	5A	1.2A
				30V DC	5A	2A

Note: Inductive load for the rated load —  $\cos \phi = 0.3$ , L/R = 7 ms

**TÜV Ratings**

Voltage	DPDT Slim	DPDT Wide	4PDT
240V AC	3A	5A	5A
30V DC	3A	5A	5A

AC:  $\cos \phi = 1.0$ , DC: L/R = 0 ms

**UL Ratings**

Voltage	Resistive			General use		
	DPDT Slim	DPDT Wide	4PDT	DPDT Slim	DPDT Wide	4PDT
240V AC	3A	5A	5A	0.8A	2A	5A
120V AC	—	—	—	1.5A	2.5A	—
100V DC	0.2A	0.4A	0.2A	0.2A	—	0.2A
30V DC	3A	5A	5A	3A	—	5A

**CSA Ratings**

Voltage	Resistive			General use		
	DPDT Slim	DPDT Wide	4PDT	DPDT Slim	DPDT Wide	4PDT
240V AC	3A	5A	5A	0.8A	2A	5A
120V AC	3A	5A	—	1.5A	2.5A	—
100V DC	—	—	—	0.2A	0.4A	0.2A
30V DC	3A	5A	5A	1.5A	2.5A	1.5A

Contactors

Terminal Blocks

Circuit Breakers

## Socket Specifications

	Sockets	Terminal	Electrical Rating	Wire Size	Torque
DIN Rail Mount Sockets	SY2S-05	M3 screws with captive wire clamp	300V, 7A	Maximum up to 2-#14AWG	5.5 - 9 in•lbs
	SM2S-05	M3 screw with captive wire clamp	300V, 10A	Maximum up to 2-#14AWG	5.5 - 9 in•lbs
	SY4S-05	M3 screw with captive wire clamp	300V, 7A*	Maximum up to 2-#14AWG	5.5 - 9 in•lbs
Finger-safe DIN Rail Mount	SY2S-05C	M3 screws with captive wire clamp, fingersafe	300V, 7A	Maximum up to 2-#14AWG	5.5 - 9 in•lbs
	SM2S-05C	M3 screw with captive wire clamp, fingersafe	300V, 10A	Maximum up to 2-#14AWG	5.5 - 9 in•lbs
	SY4S-05C	M3 screw with captive wire clamp, fingersafe	300V, 7A*	Maximum up to 2-#14AWG	5.5 - 9 in•lbs
Through Panel Mount Socket	SY2S-51	Solder	250V, 7A	—	—
	SM2S-51	Solder	250V, 10A	—	—
	SY4S-51	Solder	250V, 7A*	—	—
PCB Mount Socket	SY2S-61	PCB Mount	300V, 7A	—	—
	SY4S-61	PCB Mount	300V, 7A	—	—
	SY4S-62	PCB Mount	250V, 7A	—	—



\* When using only 2 poles of the 4-poles, the UL recognized current is 10A.

Switches & Pilot Lights

Signaling Lights

Relays & Sockets

Timers

Contactors

Terminal Blocks

Circuit Breakers

Characteristics (Reference Data)

Electrical Life Curves

AC Load  
(RY2)

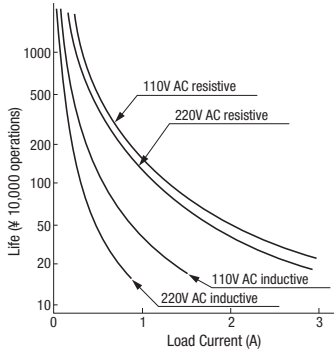

(RY4)

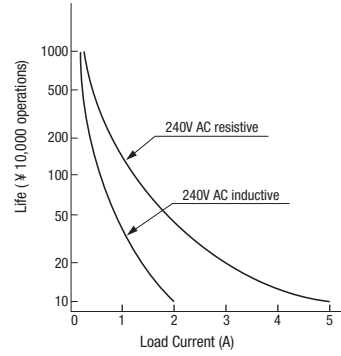

(RM2)

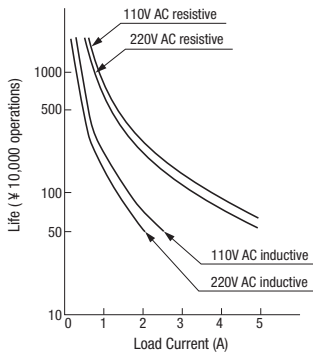

DC Load  
(RY2)

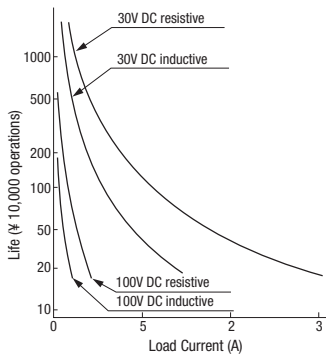

(RY4)

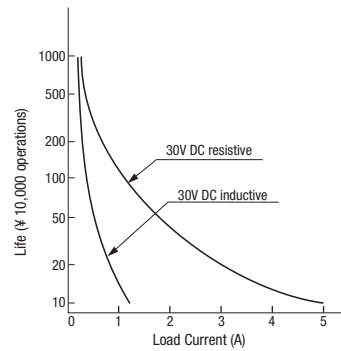

(RM2)

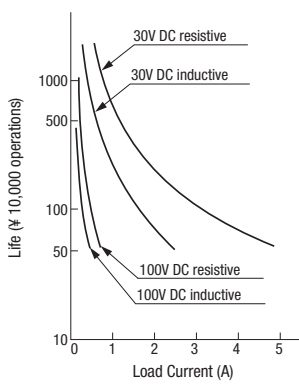

Switches & Pilot Lights  
Signalming Lights

Relays & Sockets

Timers

Contactors

Terminal Blocks

Circuit Breakers

Maximum Switching Capacity

(RY2)

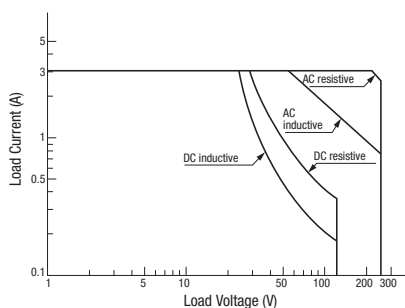

(RY4)

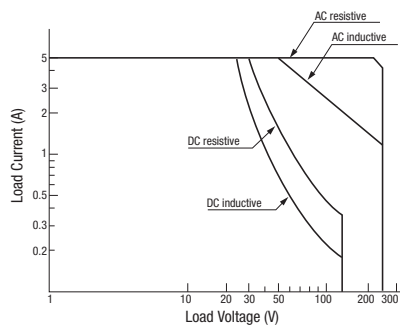

(RM2)

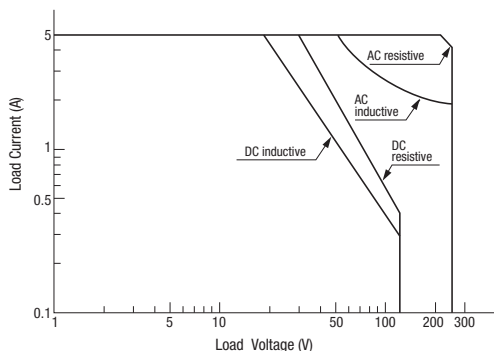

Continuous Load Current vs. Operating Temperature Curve (Standard Type, With Check Button, and Top Bracket Mounting Type)

(RY2)

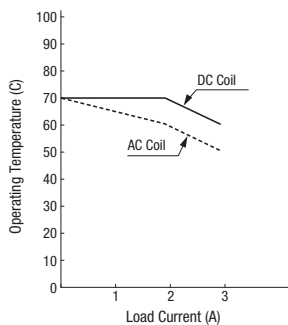

(RY4)

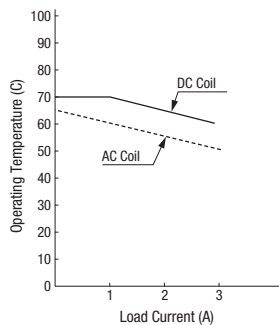

(RM2)

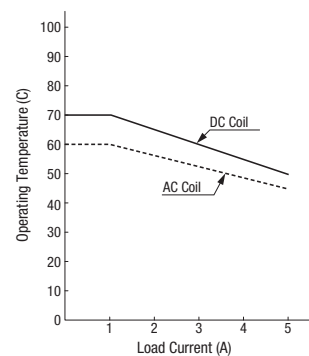

Switches & Pilot Lights

**Internal Connection (View from Bottom)**  
**Standard Type**

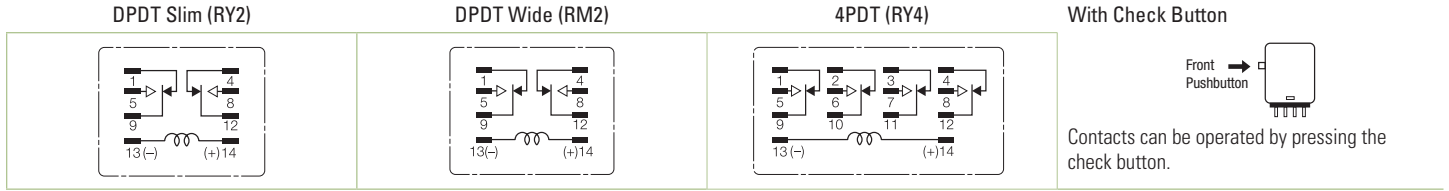

Signaling Lights

**With Indicator (-L type)**

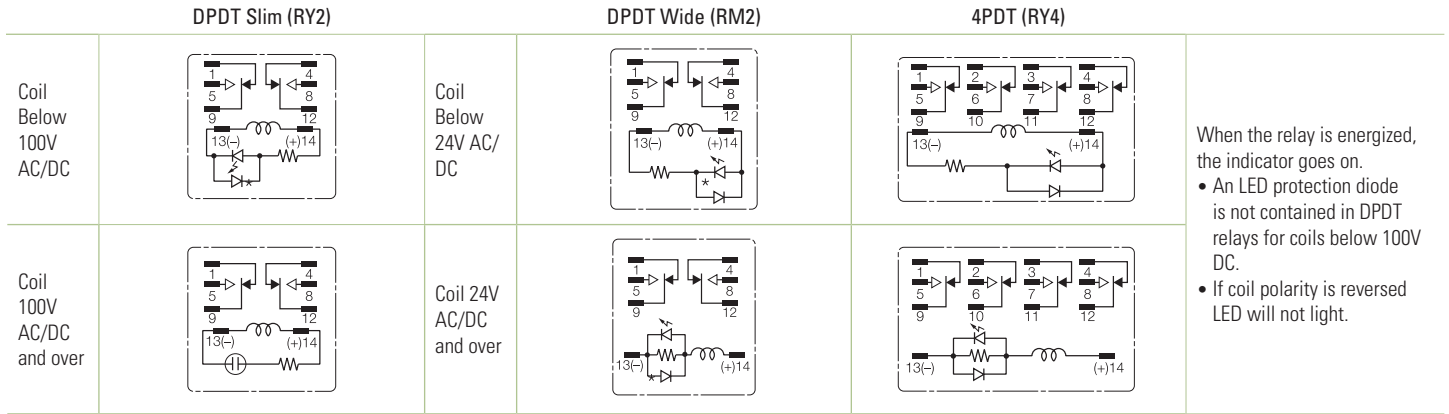

Relays & Sockets

**With Diode (-D type)**

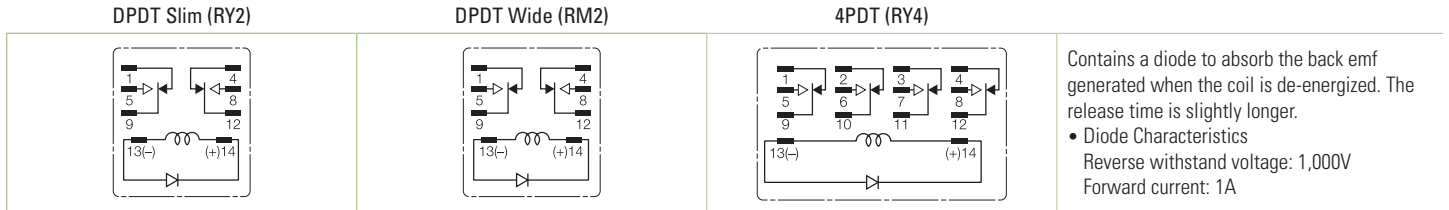

Timers

**With Indicator and Diode (-LD type)**

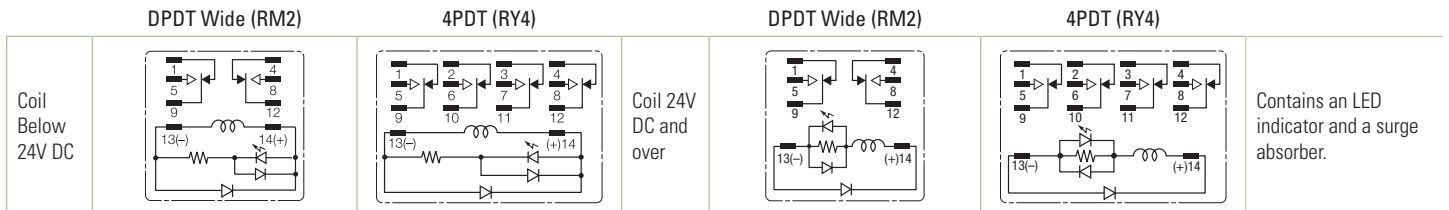

Contactors

Terminal Blocks

Circuit Breakers



## Dimensions (mm)

**RY2S**

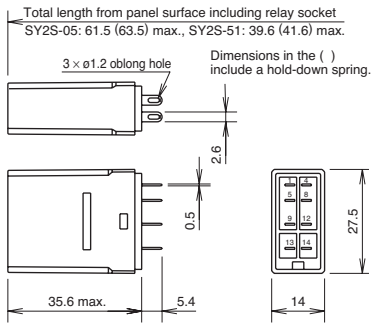

**RY4S**

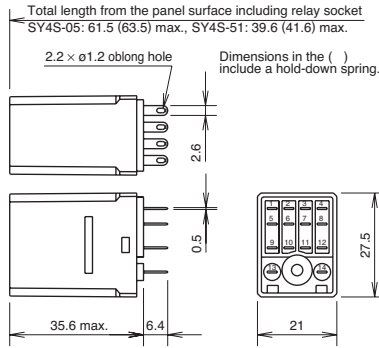

**RM2S**

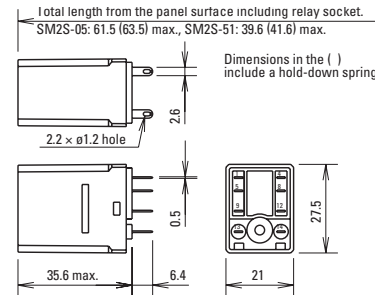

**RY2V**

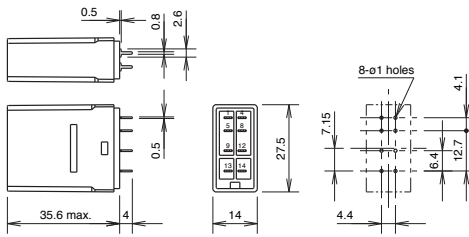

**RY4V**

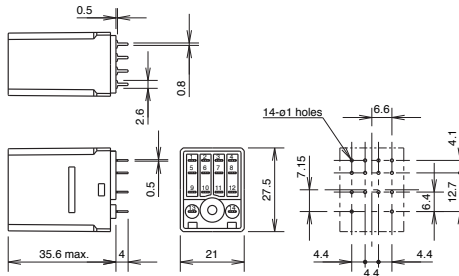

**RM2V**

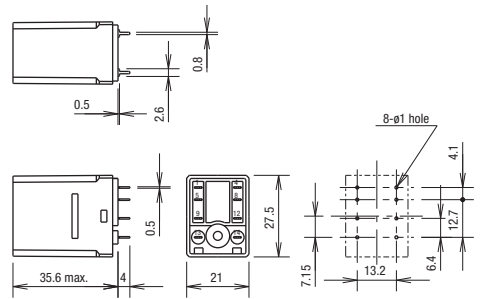

**RY2S-UT**

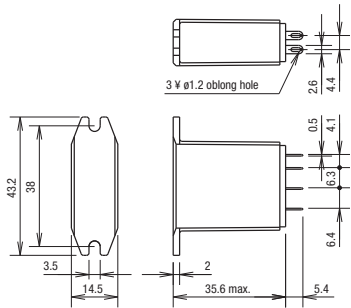

**RY4S-UT**

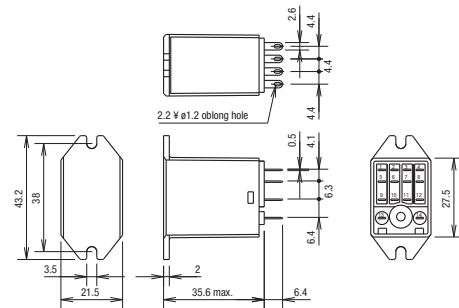

**RM2S-UT**

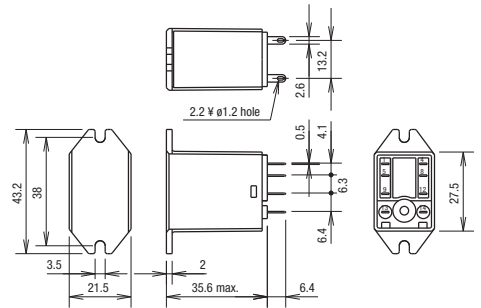

Switches & Pilot Lights

Signaling Lights

Relays & Sockets

Timers

Contactors

Terminal Blocks

Circuit Breakers

Dimensions

Switches & Pilot Lights

Signaling Lights

Relays & Sockets

Timers

Contactors

Terminal Blocks

Circuit Breakers

Standard DIN Rail Mount Sockets

SY2S-05

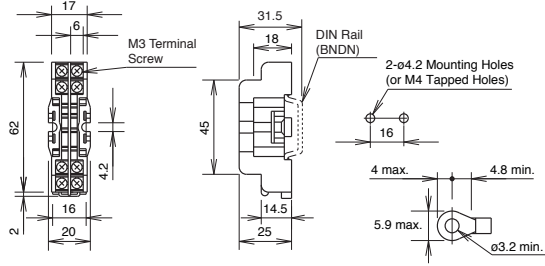

Terminal Arrangement

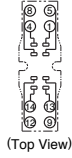

SM2S-05

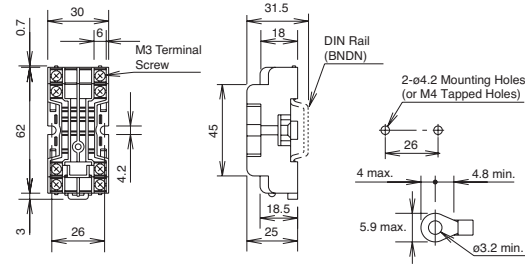

Terminal Arrangement

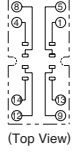

SY4S-05

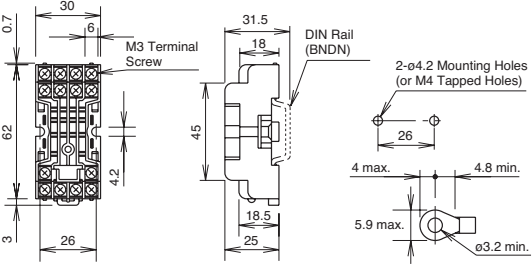

Terminal Arrangement

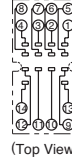

Finger-safe DIN Rail Mount Sockets

SY2S-05C

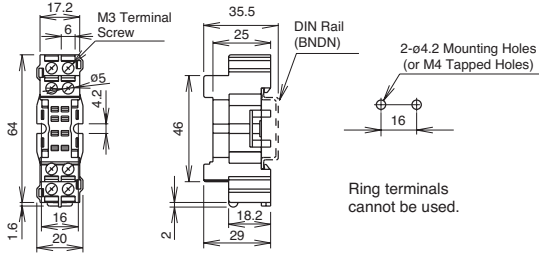

Terminal Arrangement

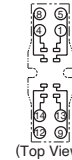

SM2S-05C

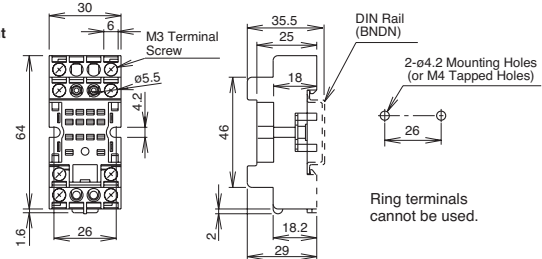

Terminal Arrangement



SY4S-05C

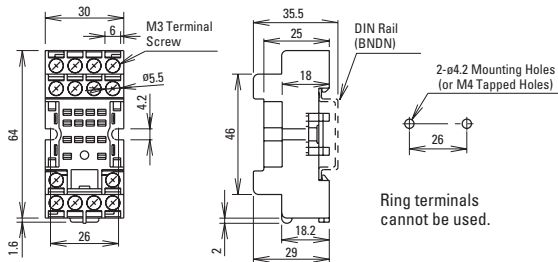

Terminal Arrangement

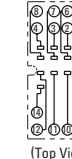

## Through Panel Mount Socket

### SY2S-51

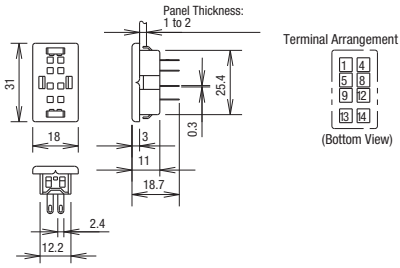

### SM2S-51

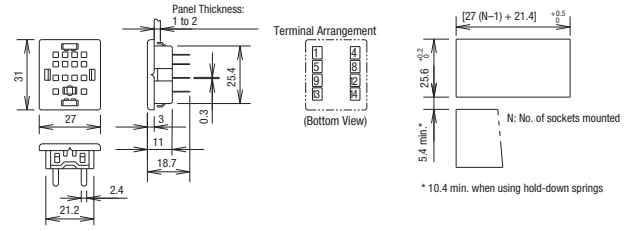

### SY4S-51

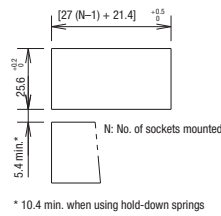
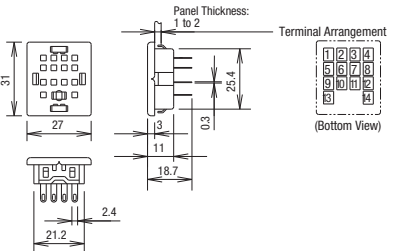

## PCB Mount Sockets

### SY2S-61

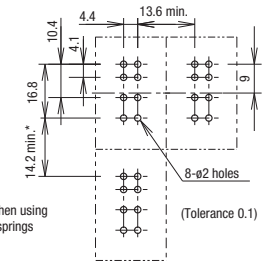
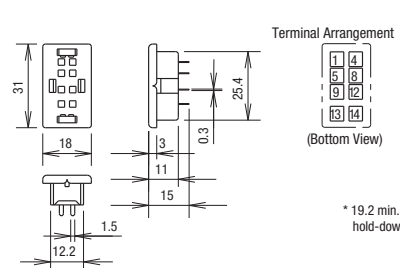

### SY4S-61

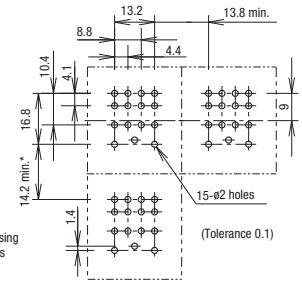
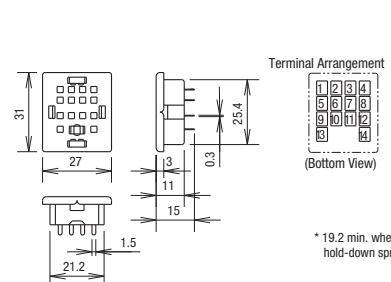

### SY4S-62

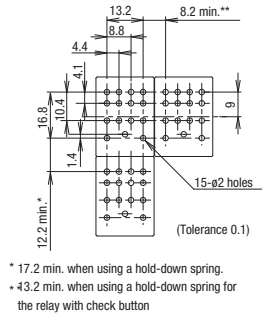
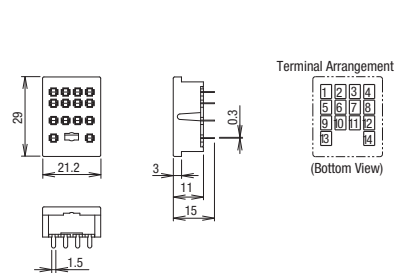

Switches & Pilot Lights

Signaling Lights

Relays & Sockets

Timers

Contactors

Terminal Blocks

Circuit Breakers