

**NEW**

# PT Series Sealed Power Toggle Switch

## Features/Benefits

- **IP66/IP68 versatile rating to withstand harsh outdoor environments, intense, wet weather, wind blown rain, dirt**
- **UL 61058-1 certified has global acceptance with no additional testing needed**
- **Integrated panel seal for extra protection**
- **Superior oil and fuel resistance**
- **High strength, heat resistant housing designed for demanding applications subject to vibration and harsh conditions**

## Typical Applications

- **Off-road, Construction/Agricultural vehicles**
- **Material handling equipment**
- **Articulating, scissor, and bucket lift controls**
- **Outdoor industrial equipment**
- **Lift gate controls**

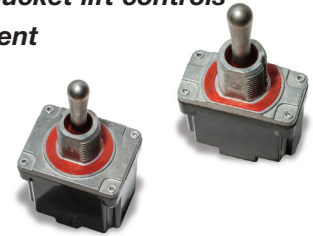

## Specifications

UL ELECTRICAL RATINGS:	UL 61058-1
MAINTAINED FUNCTIONS:	15A GP, 277VAC 50/60Hz T85 15(4)A, 277VAC 50/60Hz T85 1/2 hp, 125VAC 50/60Hz T85 1 hp, 250VAC 50/60Hz T85
MOMENTARY FUNCTIONS:	10A GP, 277VAC 50/60Hz T85 10(4)A, 277VAC 50/60Hz T85 1/4hp, 125VAC 50/60Hz T85 1/2 hp, 250VAC 50/60Hz T85
ELECTRICAL LIFE:	10,000 cycles
DC ELECTRICAL RATINGS:	Resistive Loads
ALL FUNCTIONS:	Up to 25A, 24VDC 0.75A, 125VDC 0.5A, 250VDC
MAINTAINED FUNCTIONS:	15A, 28VDC
MOMENTARY FUNCTIONS:	10A, 28VDC
DIELECTRIC STRENGTH:	2500V min. initial (terminal to toggle)
INSULATION RESISTANCE:	1000 MΩ min. initial
CONTACT RESISTANCE:	50 mΩ max. initial(terminal to toggle)
OPERATING AND STORAGE TEMPERATURE:	-40°C to +85°C
IP RATINGS:	IP66/IP68 Versatile

## Materials

CASE:	Thermoset
ACTUATOR:	Stainless Steel
PIVOT PIN:	Stainless Steel
BUSHING:	Zinc Die Cast
SEAL:	Silicone
MOVEABLE CONTACT(S):	Copper alloy, silver plated
BUTTON:	Silver Cadmium
TERMINALS:	Brass for Quick connect, silver plated brass for solder and screw terminals
HARDWARE:	Hex nut & locking ring: brass, nickel plated Screws: brass Lock washer: brass, nickel plated
PACKAGING:	Trays

## Build-A-Switch



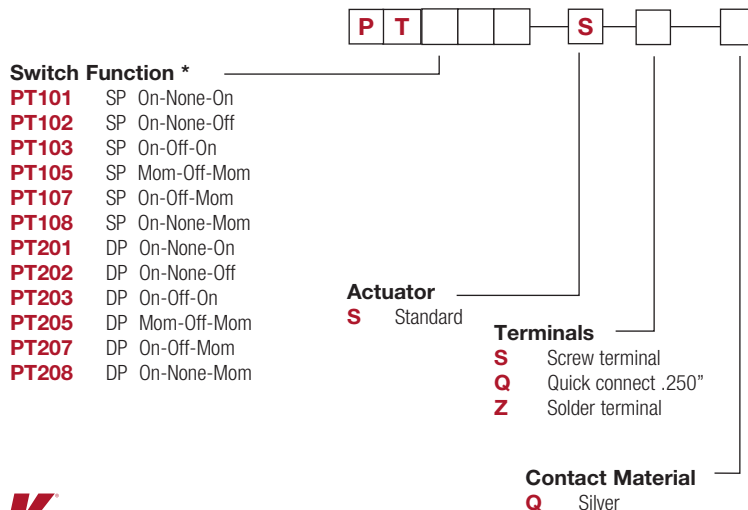





To order, simply select desired option from each category and place in the appropriate box. Available options are shown and described on pages F-53 thru F-56. For additional options not shown in catalog, consult Customer Service Center.

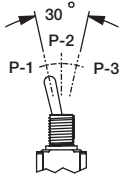

# PT Series Sealed Power Toggle Switch

**NEW**



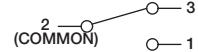



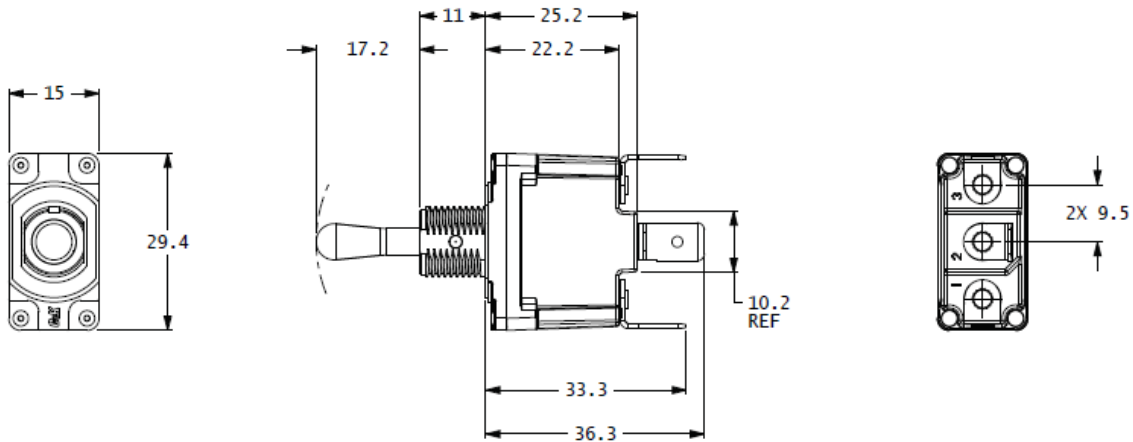

**SP**

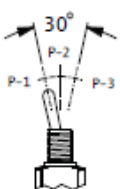
	NO. POLES	MODEL NO.	SWITCH FUNCTION			CONNECTED TERMINALS			SCHEMATIC
			POS.1	POS.2	POS.3	POS.1	POS.2	POS.3	
									
	SP	PT101	ON	NONE	ON	2-3	N/A	2-1	
		PT102*	ON	NONE	OFF	2-3	N/A	OPEN	
		PT103	ON	OFF	ON	2-3	OPEN	2-1	
		PT105	MOM	OFF	MOM				
		PT107	ON	OFF	MOM	2-3	N/A	2-1	
		PT108	ON	NONE	MOM				

\* PT102 OMIT TERMINAL 1



**DP**

	NO. POLES	MODEL NO.	SWITCH FUNCTION			CONNECTED TERMINALS			SCHEMATIC
			POS.1	POS.2	POS.3	POS.1	POS.2	POS.3	
									
	DP	PT201	ON	NONE	ON	2-3, 5-6	N/A	2-1, 4-5	
		PT202*	ON	NONE	OFF	2-3, 5-6	N/A	OPEN	
		PT203	ON	OFF	ON	2-3, 5-6	OPEN	2-1, 4-5	
		PT205	MOM	OFF	MOM				
		PT207	ON	OFF	MOM	2-3, 5-6	N/A	2-1, 4-5	
		PT208	ON	NONE	MOM				

\* PT202 OMIT TERMINAL 1 AND 4

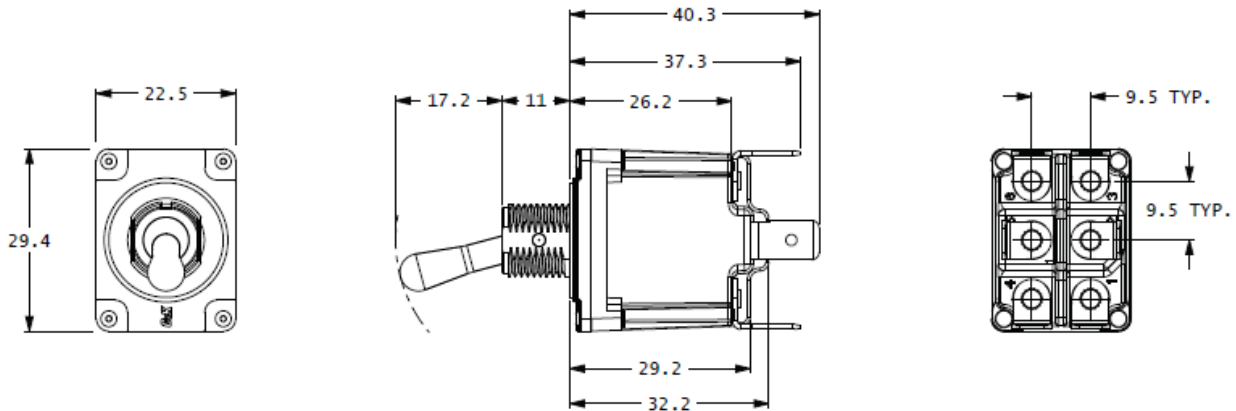

**Toggle**

**NEW**

# PT Series Sealed Power Toggle Switch

## ACTUATOR

**S** STANDARD

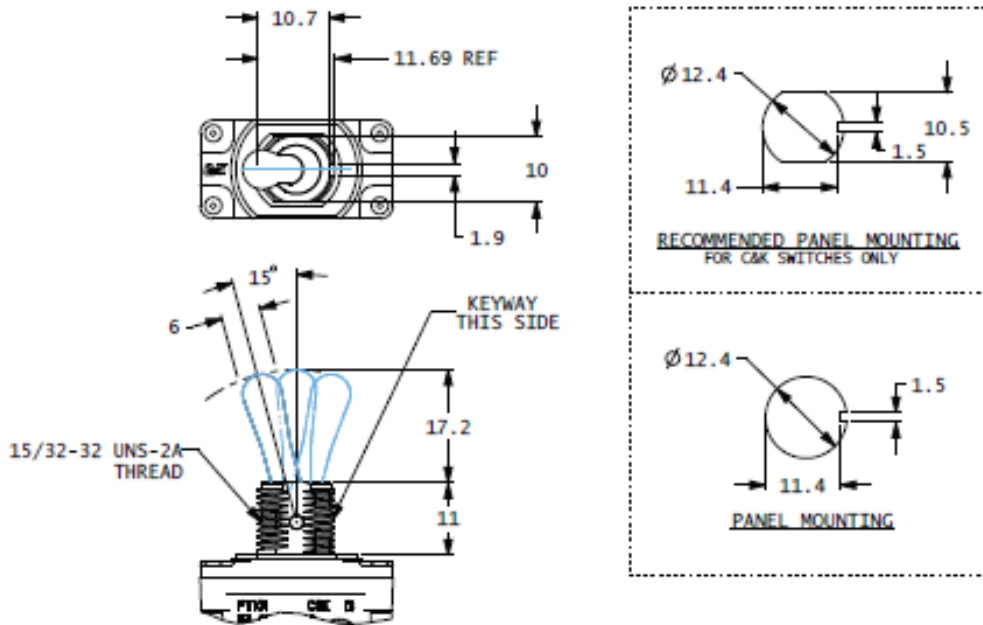

## TERMINALS

**S** SCREW TERMINAL

**Q** QUICK CONNECT

**SP**

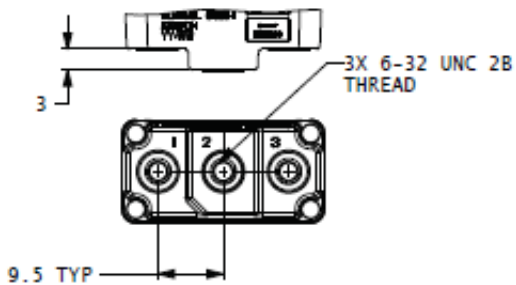

*MODEL PT101SS SHOWN*

**SP**

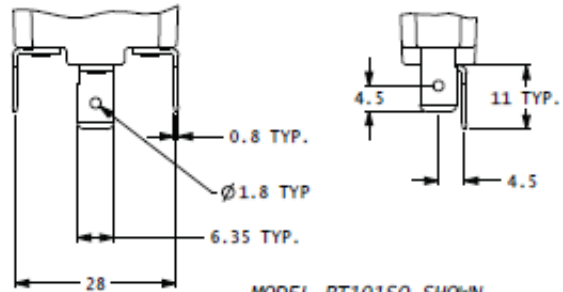

*MODEL PT101SQ SHOWN*

**DP**

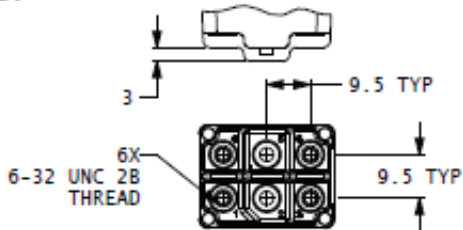

*MODEL PT201SS SHOWN*

**DP**

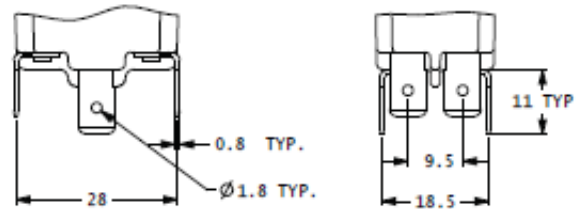

*MODEL PT201SQ SHOWN*



**F**

**Toggle**

# PT Series Sealed Power Toggle Switches

**NEW**

**Z** SOLDER TERMINAL SP

**SP**

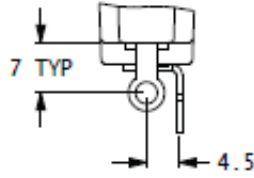
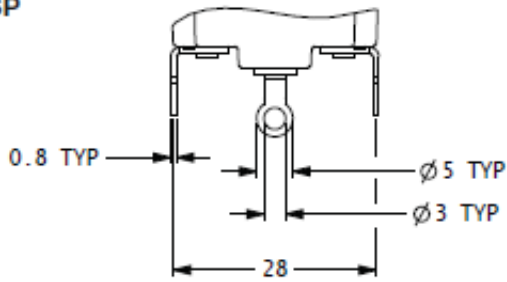

MODEL PT101SZ SHOWN

**DP**

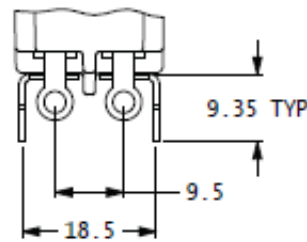
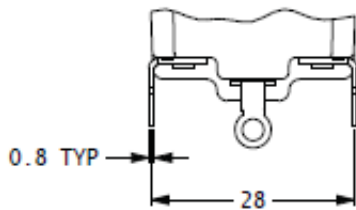

MODEL PT201SZ SHOWN

## MOUNTING HARDWARE

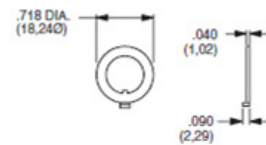
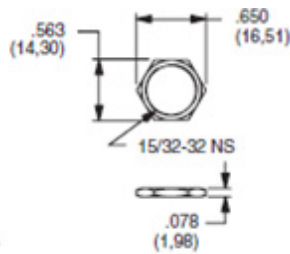
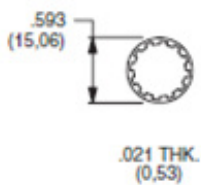

**PART NO.**  
**700302202** NICKEL PLATED

**PART NO.**  
**707100201** NICKEL PLATED

**PART NO.**  
**707200201** NICKEL PLATED WITH KEYWAY

Note: Standard hardware shipped with each switch is 1 pc each



**T**

**Toggle**