

DF-G1 Expert™ Dual Display Fiber Amplifier

Instruction Manual

Original Instructions
161999 Rev. G
22 March 2019
© Banner Engineering Corp. All rights reserved



161999

Contents

1 Product Description	3
1.1 Models	3
1.2 Overview	4
1.3 Top Panel Interface	4
2 Installation Instructions	5
2.1 Mounting Instructions	5
2.2 Installing the Fibers	5
2.3 Fiber Adapters	6
2.4 Wiring Diagrams	6
3 Operating Instructions	8
3.1 Run Mode	8
3.2 Program Mode	8
3.2.1 TEACH Selection	10
3.2.2 Response Speed	10
3.2.3 Offset Percent	10
3.2.4 Auto Thresholds	10
3.2.5 Delays/Timers	11
3.2.6 Display Readout	11
3.2.7 Gain Selection	11
3.2.8 Factory Defaults	11
3.3 Remote Input (not available on IO-Link models)	11
3.4 Adjust Mode	12
3.4.1 Two-Point TEACH	13
3.4.2 Dynamic TEACH	14
3.4.3 Window SET	16
3.4.4 Light SET	17
3.4.5 Dark SET	19
3.4.6 Calibration SET	21
3.4.7 Troubleshooting	22
4 IO-Link Interface	23
5 Specifications	24
5.1 Excess Gain Curves	25
5.2 Beam Patterns	28
5.3 Dimensions	30
6 Accessories	31
6.1 Quick-Disconnect Cordsets	31
7 Banner Engineering Corp. Limited Warranty	33

1 Product Description

Advanced sensor with dual digital displays for use with plastic and glass fiber optic assemblies

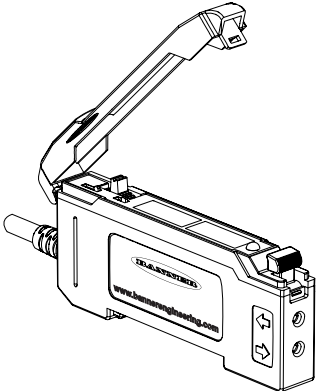

- Easy to read dual digital displays show both signal level and threshold simultaneously
- Lever action fiber clamp provides stable, reliable, and trouble-free fiber clamping
- Simple user interface ensures easy sensor set-up and programming via displays and switches/buttons, remote input teach wire, or IO-Link
- *Expert* TEACH and SET methods ensure optimal gain and threshold for all applications, especially low contrast applications
- User has full control over all operating parameters: threshold, Light Operate or Dark Operate, output timing functions, gain level, and response speed
- Thermally stable electronics minimize warm-up drift and the effect of side-by-side mounting of multiple fiber amplifiers
- ECO (economy) display mode reduces amplifier power consumption by 25%
- Cross talk avoidance algorithm allows two sensors to operate in close proximity for many applications
- Response speeds of: 200 μs (High Speed), 500 μs (Standard), 2 ms (Long Range), and 5 ms (Extra Long Range) allow the operator to optimize for fast or long distance applications
- Sleek 10 mm wide housing mounts to 35 mm DIN rail
- Visible red LED sensing beam



WARNING:

- **Do not use this device for personnel protection**
- Using this device for personnel protection could result in serious injury or death.
- This device does not include the self-checking redundant circuitry necessary to allow its use in personnel safety applications. A device failure or malfunction can cause either an energized (on) or de-energized (off) output condition.

1.1 Models

Model	Outputs	Connector ¹
DF-G1-NS-2M	Single NPN	2 m (6.5 ft) cable, 4-wire
DF-G1-PS-2M	Single PNP	
DF-G1-KS-2M	Dual outputs, 1 push-pull IO-Link and 1 PNP (complementary outputs)	
DF-G1-NS-Q5	Single NPN	150 mm (6 in) PVC pigtail, M12 Euro QD connector, 4-pin
DF-G1-PS-Q5	Single PNP	
DF-G1-KS-Q5	Dual outputs, 1 push-pull IO-Link and 1 PNP (complementary outputs)	
DF-G1-NS-Q7	Single NPN	Integral M8 Pico QD connector, 4-pin
DF-G1-PS-Q7	Single PNP	
DF-G1-KS-Q7	Dual outputs, 1 push-pull IO-Link and 1 PNP (complementary outputs)	

¹ Connector options:

- A model with a QD connector requires a mating cordset (see [Quick-Disconnect Cordsets](#) on page 31).
- For 9 m cable, change the suffix 2M to **9M** in the 2 m model number (example, DF-G1-NS-**9M**).
- For 150 mm (6 in) PVC pigtail, M8 Pico QD connector, 4-pin change the suffix 2M to **Q3** in the 2 m model number (example, DF-G1-NS-**Q3**).

1.2 Overview

The DF-G1 is an easy-to-use, DIN-rail-mountable fiber optic device. It provides high-performance sensing in low-contrast applications.

The sensor's compact housing has dual digital displays (Red/Green) and a bright output LED for easy programming and status monitoring during operation. The sensor features a single discrete output, either NPN or PNP, by model.

The DF-G1 features increased temperature compensation compared with previous fiber optic sensors. An accessory clamp is available to secure a bank of connected sensors together on a DIN rail (see [Accessories](#) on page 31).

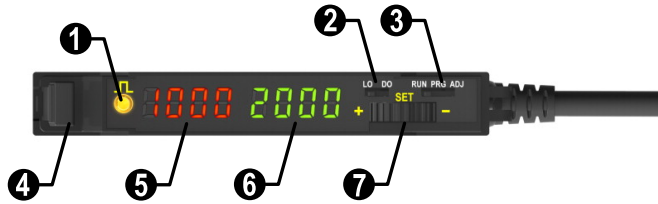

Figure 1. DF-G1 Model Features

1	Output LED
2	LO/DO Switch
3	RUN/PRG/ADJ Mode Switch
4	Lever Action Fiber Clamp
5	Red Signal Level
6	Green Threshold
7	+ /SET/ - Rocker Button

1.3 Top Panel Interface

Opening the dust cover provides access to the top panel interface. The top panel interface consists of the RUN/PRG/ADJ mode switch, LO/DO switch, +/SET/- rocker button, dual red/green digital displays, and output LED.

RUN/PRG/ADJ Mode Switch

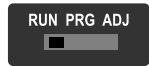

The RUN/PRG/ADJ mode switch puts the sensor in RUN, PRG (Program), or ADJ (Adjust) mode. RUN mode allows the sensor to operate normally and prevents unintentional programming changes via the +/SET/- button. PRG mode allows the sensor to be programmed through the display driven programming menu (see [Program Mode](#) on page 8). ADJ mode allows the user to perform Expert TEACH/SET methods and Manual Adjust (see [Adjust Mode](#) on page 12).

LO/DO Switch



The LO/DO switch is used to select Light Operate or Dark Operate mode. In Light Operate mode, the output is ON when the sensing condition is above the threshold (for Window SET, the output is ON when the sensing condition is inside the window). In Dark Operate mode, the output is ON when the sensing condition is below the threshold (for Window SET, the output is ON when the sensing condition is outside the window).

+ /SET/ - Rocker Button

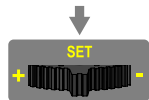

The +/SET/- rocker button is a 3-way button. The +/- positions are engaged by rocking the button left/right. The SET position is engaged by clicking down the button while the rocker is in the middle position. All three button positions are used during PRG mode to navigate the display driven programming menu. During ADJ mode, SET is used to perform TEACH/SET methods and +/- are used to manually adjust the threshold(s). The rocker button is disabled during RUN mode, except when using Window SET, see [Window SET](#) on page 16.

Red/Green Digital Displays



During RUN and ADJ mode, the Red display shows the signal level and the Green display shows the threshold. During PRG mode, both displays are used to navigate the display driven programming menu.



Output LED

The output LED provides a visible indication when the output is activated.

2 Installation Instructions

2.1 Mounting Instructions

Mount on a DIN Rail

- 1. Hook the DIN rail clip on the bottom of the DF-G1 over the edge of the DIN rail (1).
- 2. Push the DF-G1 up on the DIN rail (1).
- 3. Pivot the DF-G1 onto the DIN rail, pressing until it snaps into place (2).

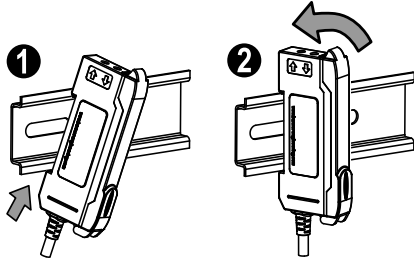

Mount to the Accessory Bracket (SA-DIN-BRACKET)

- 1. Position the DF-G1 in the SA-DIN-BRACKET.
- 2. Insert the supplied M3 screws.
- 3. Tighten the screws.

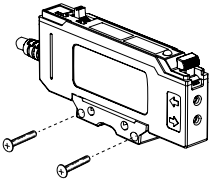

Remove from a DIN rail

- 1. Push the DF-G1 up on the DIN rail (1).
- 2. Pivot the DF-G1 away from the DIN rail and remove it (2).

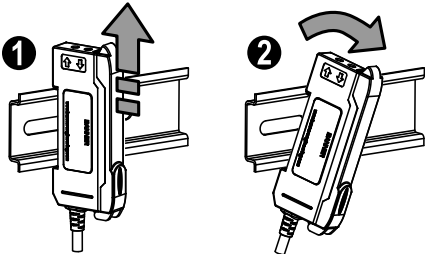

2.2 Installing the Fibers

Follow these steps to install glass or plastic fibers.

- 1. Open the dust cover.
- 2. Move the fiber clamp forward to unlock it.
- 3. Insert the fiber(s) into the fiber port(s) until they stop.
- 4. Move the fiber clamp backward to lock the fiber(s).
- 5. Close the dust cover.

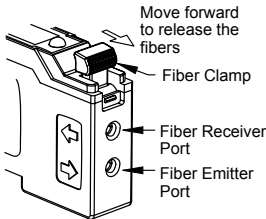

2.3 Fiber Adapters



Note: If a thin fiber with less than 2.2 mm outer diameter is used, install the fiber adapter provided with the fiber assembly to ensure a reliable fit in the fiber holder. Align the fibers to the end of the adapters. Banner includes the adapters with all fiber assemblies.

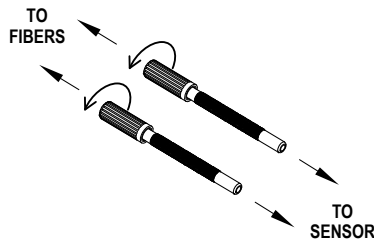

Fiber Outer Diameter (mm)	Adapter Color
Ø 1.0	Black
Ø 1.3	Red
Ø 2.2	No adapter needed

When connecting coaxial-type fiber assemblies to the amplifier, install the single-core (center) fiber to the Transmitter port, and the multi-core (outer) fiber to the Receiver port. This will result in the most reliable detection.

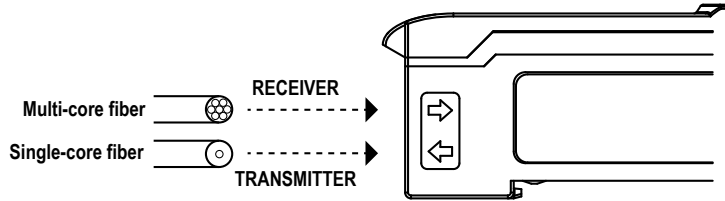

2.4 Wiring Diagrams

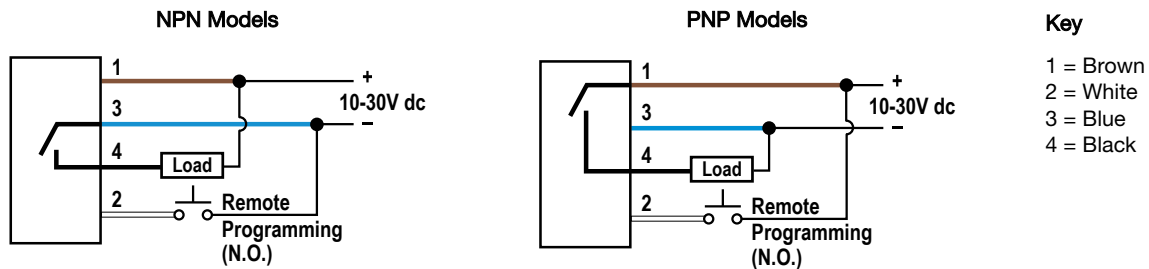

IO-Link Models

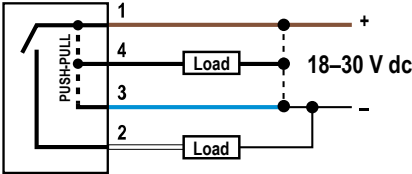

Open lead wires must be connected to a terminal block.

3 Operating Instructions

3.1 Run Mode

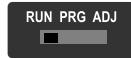

Run mode allows the sensor to operate normally and prevents unintentional programming changes. The +/-SET/- rocker button is disabled during RUN mode, except when using Window SET.

3.2 Program Mode



Program (PRG) mode allows the following settings to be programmed in the DF-G1 (refer to Program Mode Flowchart and Remote Input Flowchart for programming).

3.2.1 TEACH Selection

The DF-G1 can be programmed for one of the following TEACH/SET methods:

- Two-Point TEACH
- Dynamic TEACH
- Window SET
- Light SET
- Dark SET
- Calibration SET



Note: A **TEACH Selection** must be selected by programming before TEACH/SET methods can be used.

3.2.2 Response Speed

The DF-G1 can be programmed for one of the following Response Speeds:

Response Speed	Display Range	Crosstalk Avoidance Algorithm
200 μ s (High Speed)	0 - 4000	Disabled
500 μ s (Standard)	0 - 4000	Enabled
2000 μ s (Long Range)	0 - 9999	Enabled
5000 μ s (Extra Long Range)	0 - 9999	Enabled

3.2.3 Offset Percent

The Offset Percent is used during the Window, Light, or Dark SET methods. The threshold(s) are positioned a programmable % offset from the taught condition.

The allowable range depends upon the Response Speed Mode, as shown below:

Response Speed	MIN %	MAX %
200 μ s (High Speed)	10	999
500 μ s (Standard)	10	999
2000 μ s (Long Range)	2	999
5000 μ s (Extra Long Range)	2	999

The offset percent can also be programmed to **Minimum Offset**. This allows the DF-G1 to set the threshold(s) as close as possible to the presented condition, but still provide for reliable sensing.



Note: Offset Percent **MUST** be programmed to **Minimum Offset** for Dark SET to accept conditions of no signal (0 counts).

3.2.4 Auto Thresholds

Auto Thresholds can be programmed to be ON/OFF. The Auto Thresholds algorithm continuously tracks slow changes in the taught condition(s), and optimizes the threshold(s) to provide for reliable sensing. For Two-Point and Dynamic TEACH, the algorithm optimizes the threshold to be centered between the light and dark conditions. For Window, Light, and Dark SET, the algorithm optimizes the threshold(s) to maintain the programmed Offset Percent from the taught condition.

- After programming Auto Thresholds to ON, it is highly recommended to re-perform the TEACH/SET method
- Manual Adjustments are disabled when Auto Thresholds are ON
- Auto Thresholds are automatically disabled in Calibration SET (see [Calibration SET](#) on page 21)
- Severe contamination/changes in the taught condition can prevent the Auto Thresholds algorithm from optimizing the threshold(s). If this occurs, the DF-G1 enters a **Threshold Alert** or **Threshold Error** state. See [Troubleshooting](#) on page 22 for more explanation.

3.2.5 Delays/Timers OFF dLY OFF 1SHd On dLY On 1SHd

ON/OFF Delays and ON/OFF One-Shot timers can be programmed between 1 - 9999 ms (a value of 0 disables the delay/timer). [Figure 3](#) on page 11 defines how the delays/timers affect the output behavior.

Some combinations of delays/timers are not allowed. The DF-G1 programming menu automatically disables invalid combinations of delays/timers. The following table shows the allowable combinations of delays/timers:

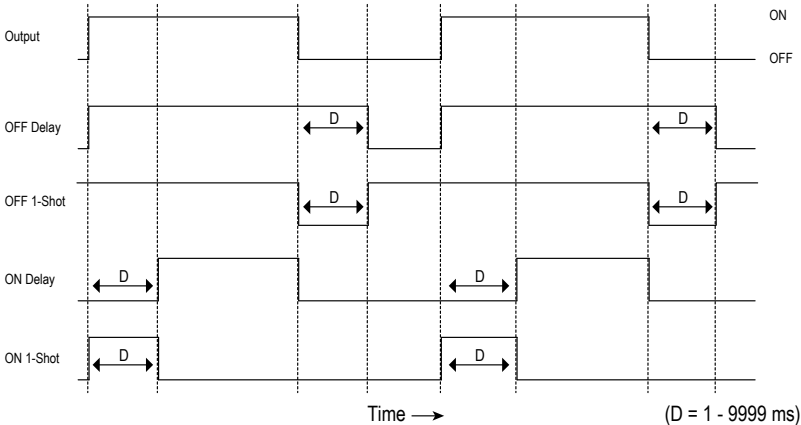

Figure 3. DF-G1 Delays/Timers

	OFF Delay	OFF One-Shot Timer	ON Delay	ON One-Shot Timer
OFF Delay	-	OK	OK	N/A
OFF One-Shot Timer	OK	-	N/A	N/A
ON Delay	OK	N/A	-	OK
ON One-Shot Timer	N/A	N/A	OK	-

3.2.6 Display Readout dISP rERd

The readout of the digital displays can be programmed for the following options:

- Signal/Threshold readout - Numeric (1234) or % (123P)
- ECO mode - Enabled or Disabled (ECO mode dims the displays to reduce current consumption)
- Display Orientation - Normal (1234) or Flipped (ᄀᄀᄀᄀ)

3.2.7 Gain Selection GAIN SEL

The DF-G1 can operate in Auto Gain mode or the Gain can be fixed to be in Gain 1..8. In Auto Gain, the DF-G1 optimizes the gain during a TEACH/SET method for the presented condition(s). While viewing the fixed gains in the Gain Selection choice list, the DF-G1 will automatically switch to the selected gain and display the measured signal on the Red display. This allows for easy and quick evaluation of the fixed gain mode.

3.2.8 Factory Defaults FACTY DEF

The Factory Defaults menu allows the DF-G1 to be easily restored back to original factory default settings (see **Factory Default Settings** in Specifications).

3.3 Remote Input (not available on IO-Link models)

The remote input may be used to perform TEACH/SET methods and to program the sensor remotely. Connect the white input wire of the sensor to ground (0 V dc), with a remote switch connected between them. Pulse the remote input according to the diagram shown in [Figure 4](#) on page 12. Follow the instructions in the TEACH/SET sections in [Adjust Mode](#) on page 12 to perform a TEACH/SET method.

The sensor exits TEACH and remote programming modes after a 60 second timeout. Users may exit TEACH and remote programming modes by setting the remote input low for more than 2 seconds. In either case, the sensor returns to Run mode without saving any new settings.

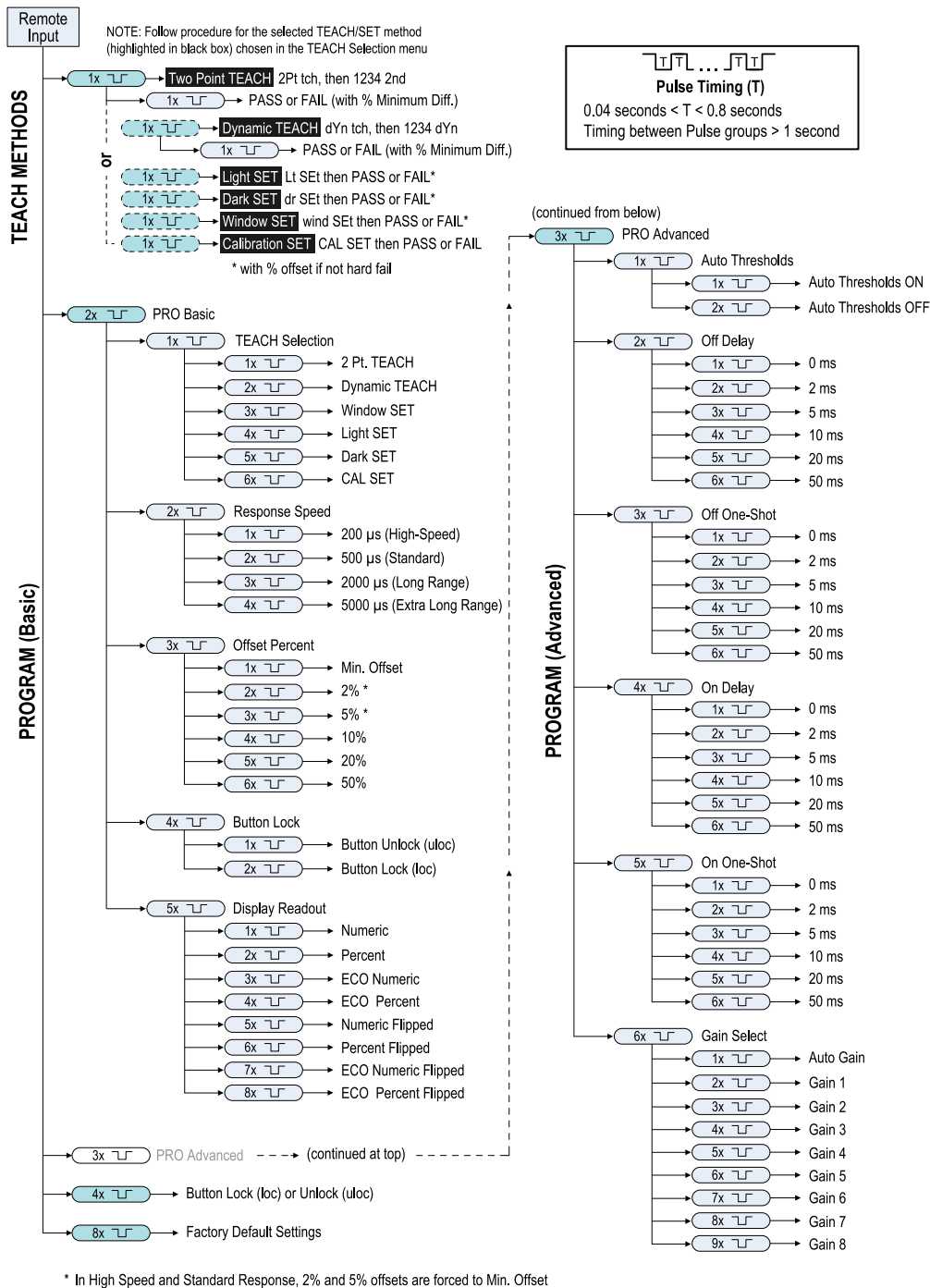

* In High Speed and Standard Response, 2% and 5% offsets are forced to Min. Offset

Figure 4. Remote Input Flowchart

3.4 Adjust Mode

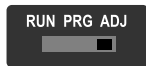

Sliding the RUN/PRG/ADJ mode switch to the ADJ position allows the user to perform Expert TEACH/SET methods and Manual Adjustment of the threshold(s).

3.4.1 Two-Point TEACH

- Establishes a single switching threshold
- Threshold can be adjusted by using the "+" and "-" rocker button (Manual Adjust)

Two-Point TEACH is used when two conditions can be presented statically to the sensor. The sensor locates a single sensing threshold (the switch point) midway between the two taught conditions, with the Output ON condition on one side, and the Output OFF condition on the other.

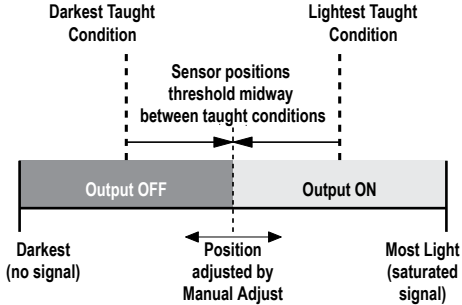

Figure 5. Two-Point TEACH (Light Operate shown)

The Output ON and OFF conditions can be reversed by using the LO/DO (Light Operate/ Dark Operate) switch.

Two-Point TEACH and Manual Adjust

Moves switching threshold value up or down to make adjustments

- Slide Mode switch to ADJ to enter Adjust mode
- Press "+" to increase; press "-" to decrease
 - GREEN display shows the switching threshold value
 - 2 seconds after adjustment, the GREEN display will flash 3 times to confirm
- Slide Mode switch to RUN to complete operation



Remember: Manual adjustments are disabled when Auto Thresholds are ON

Follow these steps to perform a Two-Point TEACH:



Note: TEACH Selection must be programmed to 2Pt tch.

1. Enter Adjust mode.

Method	Action	Result
SET Button ²	Set the Mode switch to ADJ.	Display: Red - Signal Level; Green - Threshold
Remote Input ³	No action is required; sensor is ready for the Two-Point TEACH method	

2. Teach the first condition.

Method	Action	Result
SET Button	a. Present the first condition. b. Click the SET rocker button.	Display: Flashes "2Pt tch" then holds on "1234 2nd"
Remote Input	a. Present the first condition. b. Single-pulse the remote input.	

² SET Button: 0.04 seconds ≤ "Click" ≤ 0.8 seconds
³ Remote Input: 0.04 seconds ≤ T ≤ 0.8 seconds

3. Teach the second condition.

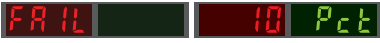
Method	Action	Result
SET Button	a. Present the second condition. b. Click the SET rocker button.	<p>TEACH Accepted</p> <p>Displays alternate "PASS" and % Minimum Difference⁴; Sensor returns to Adjust mode</p>  <p>TEACH Not Accepted</p> <p>Displays alternate "FAIL" and % Minimum Difference⁴; Sensor returns to Adjust mode</p> 
Remote Input	a. Present the second condition. b. Single-pulse the remote input.	

4. Return to Run mode.

Method	Action	Result
SET Button	Move the Mode switch to RUN	<p>Display: Red - Signal Level; Green - Threshold</p> 
Remote Input	No action is required; sensor returns to RUN mode automatically	

3.4.2 Dynamic TEACH

- Teaches on-the-fly
- Establishes a single switching threshold
- Threshold can be adjusted using "+" and "-" rocker button (Manual Adjust)

Dynamic TEACH is best used when a machine or process may not be stopped for teaching. The sensor learns during actual sensing conditions, taking multiple samples of the light and dark conditions and automatically setting the threshold at the optimum level.

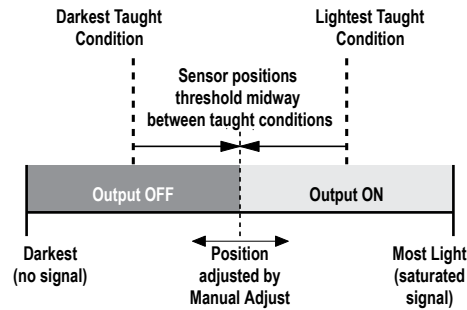

Figure 6. Dynamic TEACH (Light Operate shown)

The output ON and OFF conditions can be reversed using the LO/DO switch.

Dynamic TEACH and Manual Adjust

Moves switching threshold value up or down to make adjustments

- Slide Mode switch to ADJ to enter Adjust mode
- Press "+" to increase; press "-" to decrease
 - GREEN display shows the switching threshold value
 - 2 seconds after adjustment, GREEN display will flash 3 times to confirm
- Slide Mode switch to RUN to complete operation

⁴ See [Troubleshooting](#) on page 22 for more explanation of the % Minimum Difference displayed after the Two-Point TEACH method.





Remember: Manual adjustments are disabled when Auto Thresholds are ON

Follow these steps to perform **Dynamic TEACH**:





Note: TEACH Selection must be programmed to **dYn tch**.

1. Enter Adjust Mode.

Method	Action	Result
SET Button ⁵	Set Mode switch to ADJ 	Display: Red - Signal Level; Green - Threshold 
Remote Input ⁶	No action required; sensor is ready for Dynamic TEACH method	

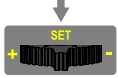



2. Enter Dynamic TEACH.

Method	Action	Result
SET Button	Click the SET rocker button 	Display: Flashes "dYn tch" then holds on "1234 dYn" 
Remote Input	Single-pulse remote input 	

3. Present ON and OFF Conditions.

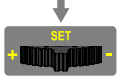
Method	Action	Result
SET Button	Present ON and OFF conditions	Display: Red - Signal Level; Green - Threshold 
Remote Input	Present ON and OFF conditions	

4. Exit Dynamic TEACH.



Method	Action	Result
SET Button	Click the SET rocker button 	<p>TEACH Accepted</p> <p>Displays alternate "PASS" with % Minimum Difference⁷, Sensor returns to Adjust mode</p>  <p>TEACH Not Accepted</p> <p>Displays alternate "FAIL" with % Minimum Difference⁷, Sensor returns to Adjust mode</p> 
Remote Input	Single-pulse remote input 	

5. Return to RUN Mode.

⁵ SET Button: 0.04 seconds ≤ "Click" ≤ 0.8 seconds

⁶ Remote Input: 0.04 seconds ≤ T ≤ 0.8 seconds

⁷ See [Troubleshooting](#) on page 22 for more explanation of the % Minimum Difference displayed after the Dynamic TEACH method.

Method	Action	Result
SET Button	Move Mode switch to RUN 	Display: Red - Signal Level; Green - Threshold 
Remote Input	No action required; sensor returns to RUN mode automatically	

3.4.3 Window SET

- Sets window thresholds that extend a programmable % offset above and below the presented condition
- All other conditions (lighter or darker) cause the output to change state
- Sensing window center can be adjusted using "+" and "-" rocker button (Manual Adjust)
- Recommended for applications where a product may not always appear in the same place, or when other signals may appear
- See Program Mode for programming the Offset Percent setting

A single sensing condition is presented, and the sensor positions window thresholds a programmable % offset above and below the presented condition. In LO mode, Window SET designates a sensing window with the Output ON condition inside the window, and the Output OFF conditions outside the window.

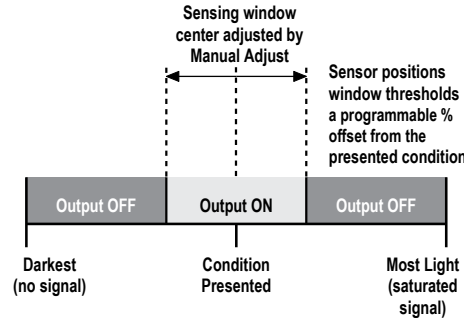

Figure 7. Window SET (Light Operate shown)

Output ON and OFF conditions can be reversed using the LO/DO switch.

Window SET and Manual Adjust

Moves sensing window center value up or down to make adjustments

- Slide Mode switch to ADJ to enter Adjust mode
- Press "+" to increase; press "-" to decrease
 - GREEN display shows the sensing window center value
 - 2 seconds after adjustment, the GREEN display will flash 3 times to confirm
- Slide Mode switch to RUN to complete operation



Remember: Manual adjustments are disabled when Auto Thresholds are ON

Follow these steps to perform a Window SET:







Note: TEACH Selection must be programmed to **wind SET**.

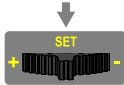

1. Enter Adjust Mode

Method	Action	Result
SET Button ⁸	Set Mode switch to ADJ 	Display: Red - Signal Level; Green - Threshold 
Remote Input ⁹	No action required; sensor is ready for Window SET method	

2. SET Sensing Condition

Method	Action	Result
SET Button	<ul style="list-style-type: none"> Present sensing condition Click the SET rocker button  	<p>Threshold Condition Accepted Displays read "wInd SET" then alternate "PASS" with % Offset¹⁰; Sensor returns to Adjust mode</p> 
Remote Input	<ul style="list-style-type: none"> Present sensing condition Single-pulse the remote input  	<p>Threshold Condition Not Accepted Displays read "wInd SET" then alternate "FAIL" with minimum % Offset¹⁰ for sensing condition; Sensor returns to Adjust mode</p> 

3. Return to RUN Mode

Method	Action	Result
SET Button	Move Mode switch to Run 	Display: Red - Signal Level; Green - Window Center (see Figure 8 on page 17 for instructions on how to display upper and lower thresholds)
Remote Input	No action required; sensor returns to Run mode automatically	

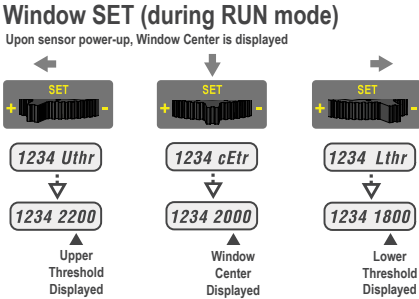

Figure 8. Upper and Lower Thresholds

3.4.4 Light SET

- Sets a threshold a programmable % offset below the presented condition
- Changes output state on any condition darker than the threshold condition
- Threshold can be adjusted using "+" and "-" rocker button (Manual Adjust)

⁸ SET Button: 0.04 seconds ≤ "Click" ≤ 0.8 seconds
⁹ Remote Input: 0.04 seconds ≤ T ≤ 0.8 seconds
¹⁰ See [Troubleshooting](#) on page 22 for more explanation of the % Offset displayed after the Window SET method

- Recommended for applications where only one condition is known, for example a stable light background with varying darker targets
- See Program Mode for programming the Offset Percent setting

A single sensing condition is presented, and the sensor positions a threshold a programmable % offset below the presented condition. When a condition darker than the threshold is sensed, the output either turns ON or OFF, depending on the LO/DO setting.

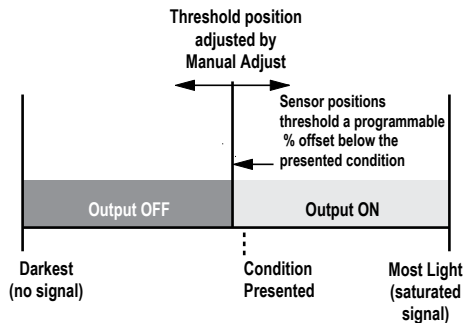

Figure 9. Light SET (Light Operate shown)

Light SET and Manual Adjust

Moves switching threshold value up or down to make adjustments

- Slide Mode switch to ADJ to enter Adjust mode
- Press "+" to increase; press "-" to decrease
 - GREEN display shows the switching threshold value
 - 2 seconds after adjustment, the GREEN display will flash 3 times to confirm
- Slide Mode switch to RUN to complete operation



Remember: Manual adjustments are disabled when Auto Thresholds are ON

Follow these steps to perform a Light SET:



Note: TEACH Selection must be programmed to Lt SET.





1. Enter Adjust Mode

Method	Action	Result
SET Button ¹¹	Set Mode switch to ADJ 	Display: Red - Signal Level; Green - Threshold 
Remote Input ¹²	No action is required; sensor is ready for Light SET method	

2. SET Sensing Condition

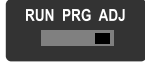
¹¹ SET Button: 0.04 seconds ≤ "Click" ≤ 0.8 seconds

¹² Remote Input: 0.04 seconds ≤ T ≤ 0.8 seconds

Method	Action	Result
SET Button	<ul style="list-style-type: none"> Present sensing condition Click the SET rocker button 	<p>Threshold Condition Accepted Displays read "Lt SET" then alternate "PASS" with % Offset¹³; Sensor returns to Adjust mode</p> 
Remote Input	<ul style="list-style-type: none"> Present sensing condition Single-pulse the remote input 	<p>Threshold Condition Not Accepted Displays read "Lt SET" then alternate "FAIL" with minimum % Offset¹³ for sensing condition; Sensor returns to Adjust mode</p> 

3. Return to RUN Mode

Method	Action	Result
SET Button	Move Mode switch to RUN	Display: Red - Signal Level; Green - Threshold
Remote Input	No action required; sensor returns to RUN mode automatically	

3.4.5 Dark SET

- Sets a threshold a programmable % offset above the presented condition
- Any condition lighter than the threshold condition causes the output to change state
- Threshold can be adjusted using "+" and "-" rocker button (Manual Adjust)
- Recommended for applications where only one condition is known, for example a stable dark background with varying lighter targets
- See Program Mode for programming the Offset Percent setting

 **Note:** Offset Percent MUST be programmed to **Minimum Offset** to accept conditions of no signal (0 counts).

A single sensing condition is presented, and the sensor positions a threshold a programmable % offset above the presented condition. When a condition lighter than the threshold is sensed, the output either turns ON or OFF, depending on the LO/DO setting.

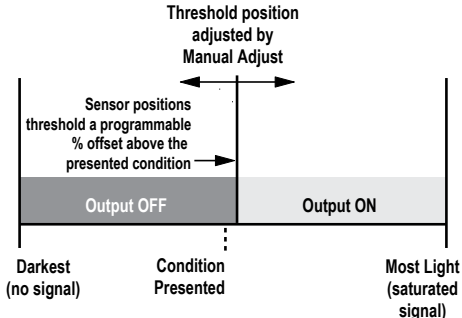

Figure 10. Dark SET (Light Operate shown)

¹³ See [Troubleshooting](#) on page 22 for more explanation of the % Offset displayed after the Light SET method

Dark SET and Manual Adjust

Moves switching threshold value up or down to make adjustments

- Slide Mode switch to ADJ to enter Adjust mode
- Press "+" to increase; press "-" to decrease
 - GREEN display shows the switching threshold value
 - 2 seconds after adjustment, the GREEN display will flash 3 times to confirm
- Slide Mode switch to RUN to complete operation





Remember: Manual adjustments are disabled when Auto Thresholds are ON

Follow these steps to perform a Dark SET:





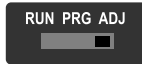

Note: TEACH Selection must be programmed to **dr SET**.



1. Enter Adjust Mode.

Method	Action	Result
SET Button ¹⁴	Set Mode switch to ADJ 	Display: Red - Signal Level; Green - Threshold 
Remote Input ¹⁵	No action required; sensor is ready for Dark SET method	

2. SET Sensing Condition.

Method	Action	Result
SET Button	<ul style="list-style-type: none"> • Present sensing condition • Click the SET rocker button  	<p>Threshold Condition Accepted Displays read "dr SET" then alternate "PASS" with % Offset¹⁶; Sensor returns to Adjust mode</p> 
Remote Input	<ul style="list-style-type: none"> • Present sensing condition • Single-pulse the remote input  	<p>Threshold Condition Not Accepted Displays read "dr SET" then alternate "FAIL" with minimum % Offset¹⁶ for sensing condition; Sensor returns to Adjust mode</p> 

3. Return to RUN Mode.

Method	Action	Result
SET Button	Move Mode switch to RUN 	Display: Red - Signal Level; Green - Threshold 
Remote Input	No action required; sensor returns to RUN mode automatically	

¹⁴ SET Button: 0.04 seconds ≤ "Click" ≤ 0.8 seconds

¹⁵ Remote Input: 0.04 seconds ≤ T ≤ 0.8 seconds

¹⁶ See [Troubleshooting](#) on page 22 for more explanation of the % Offset displayed after the Dark SET method

3.4.6 Calibration SET

- Sets a threshold exactly at the presented condition
- Threshold can be adjusted using "+" and "-" rocker button (Manual Adjust)

A single sensing condition is presented, and the sensor positions a threshold exactly at the presented condition. When a condition lighter than the threshold is sensed, the output either turns ON or OFF, depending on the LO/DO setting.

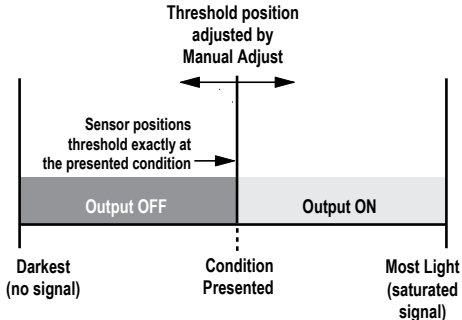

Figure 11. Calibration SET (Light Operate shown)

Calibration SET and Manual Adjust

Moves switching threshold value up or down to make adjustments

- Slide Mode switch to ADJ to enter Adjust mode
- Press "+" to increase; press "-" to decrease
 - GREEN display shows the switching threshold value
 - 2 seconds after adjustment, the GREEN display will flash 3 times to confirm
- Slide Mode switch to RUN to complete operation





Remember: Auto Thresholding is automatically disabled in Calibration SET

Follow these steps to perform a Calibration SET:







Note: TEACH Selection must be programmed to **CAL SET**.

1. Enter Adjust Mode

Method	Action	Result
SET Button ¹⁷	<ul style="list-style-type: none"> • Set Mode switch to ADJ 	Display: Red - Signal Level; Green - Threshold 
Remote Input ¹⁸	No action required; sensor is ready for Calibration SET method	



2. SET Sensing Condition

Method	Action	Result
SET Button	<ul style="list-style-type: none"> • Present sensing condition • Click the SET rocker button 	Threshold Condition Accepted Displays read "cAL SET" then flashes "PASS"; Sensor returns to Adjust mode 
Remote Input	<ul style="list-style-type: none"> • Present sensing condition • Single-pulse the remote input 	Threshold Condition Unacceptable Displays read "cAL SET" then flashes "FAIL"; Sensor returns to Adjust mode 

¹⁷ SET Button: 0.04 seconds ≤ "Click" ≤ 0.8 seconds

¹⁸ Remote Input: 0.04 seconds ≤ T ≤ 0.8 seconds

3. Return to RUN Mode

Method	Action	Result
SET Button	Move Mode switch to RUN 	Display: Red - Signal Level; Green - Threshold 
Remote Input	No action required; sensor returns to RUN mode automatically	

3.4.7 Troubleshooting

Manual Adjustments Disabled

Manual adjustments are disabled when Auto Thresholds are ON. If a manual adjustment is attempted while Auto Thresholds are ON, the Green display will flash .

Percent Minimum Difference after TEACH

The Two-Point and Dynamic TEACH methods will flash a % minimum difference on the displays after a PASS or FAIL.

Value	PASS/FAIL	Description
0 to 99%	FAIL	The difference of the taught conditions does not meet the required minimum
100 to 300%	PASS	The difference of the taught conditions just meets/exceeds the required minimum, minor sensing variables may affect sensing reliability
300 to 600%	PASS	The difference of the taught conditions sufficiently exceeds the required minimum, minor sensing variables will not affect sensing reliability
600% +	PASS	The difference of the taught conditions greatly exceeds the required minimum, very stable operation



Percent Offset after SET

The Window, Dark, and Light SET methods will flash a % offset on the displays after a PASS or FAIL.

SET Result	% Offset Meaning
PASS (with % Offset)	Displays the % offset used for the SET method
FAIL (with % Offset)	Displays the minimum required % offset necessary to PASS the SET method
FAIL (without % Offset)	Presented condition cannot be used for the SET method

Threshold Alert or Threshold Error

Severe contamination/changes in the taught condition can prevent the Auto Thresholds algorithm from optimizing the threshold(s).

State	Display	Description	Corrective Action
Threshold Alert	Alternates  and 	The threshold(s) cannot be optimized, but the sensor's output will still continue to function	Cleaning/correcting the sensing environment and/or a re-teach of the sensor is highly recommended
Threshold Error		The threshold(s) cannot be optimized, and the sensor's output will stop functioning	Cleaning/correcting the sensing environment and/or a re-teach of the sensor is required

4 IO-Link Interface

IO-Link is a point-to-point communication link between a master device and sensor. Use IO-Link to parameterize sensors and transmit process data automatically.

For the latest IO-Link protocol and specifications, see www.io-link.com.

Each IO-Link device has an IODD (IO Device Description) file that contains information about the manufacturer, article number, functionality etc. This information can be easily read and processed by the user. Each device can be unambiguously identified via the IODD as well as via an internal device ID. Download the DF-G1 Expert Fiber Amplifier's IO-Link IODD package (p/n 18491) from Banner Engineering's website at www.bannerengineering.com.

Banner has also developed Add On Instruction (AOI) files to simplify ease-of-use between the DF-G1 Expert Fiber Amplifier, multiple third-party vendors' IO-Link masters, and the Logix Designer software package for Rockwell Automation PLCs. Three types of AOI files for Rockwell Allen-Bradley PLCs are listed below. These files and more information can be found at www.bannerengineering.com.

Process Data AOIs—These files can be used alone, without the need for any other IO-Link AOIs. The job of a Process Data AOI is to intelligently parse out the Process Data word(s) in separate pieces of information. All that is required to make use of this AOI is an EtherNet/IP connection to the IO-Link Master and knowledge of where the Process Data registers are located for each port.

Parameter Data AOIs—These files require the use of an associated IO-Link Master AOI. The job of a Parameter Data AOI, when working in conjunction with the IO-Link Master AOI, is to provide quasi-realtime read/write access to all IO-Link parameter data in the sensor. Each Parameter Data AOI is specific to a given sensor or device.

IO-Link Master AOIs—These files require the use of one or more associated Parameter Data AOIs. The job of an IO-Link Master AOI is to translate the desired IO-Link read/write requests, made by the Parameter Data AOI, into the format a specific IO-Link Master requires. Each IO-Link Master AOI is customized for a given brand of IO-Link Master.

Add and configure the relevant Banner IO-Link Master AOI in your ladder logic program first; then add and configure Banner IO-Link Device AOIs as desired, linking them to the Master AOI as shown in the relevant AOI documentation.

5 Specifications

Sensing Beam

660 nm visible red

Supply Voltage

NPN/PNP models: 10 to 30 V dc Class 2 (10% maximum ripple)

IO-Link models: 18 to 30 V dc (10% maximum ripple)

Power and Current Consumption (exclusive of load)

Standard display mode: 960 mW, Current consumption < 40 mA at 24 V dc

ECO display mode: 720 mW, Current consumption < 30 mA at 24 V dc

Supply Protection Circuitry

Protected against reverse polarity and transient overvoltages

Delay at Power-Up

500 milliseconds maximum; outputs do not conduct during this time

Output Configuration

NPN/PNP models: 1 current sinking (NPN) or 1 current sourcing (PNP) output, depending on model

IO-Link models: 1 push-pull and 1 PNP (complementary outputs)

Repeatability

High Speed: 66 µs, Standard/Long Range/Extra Long Range: 100 µs

Connections

PVC-jacketed 2 m or 9 m (6.5 ft. or 30 ft.) 4-wire integral cable; or integral 4-pin M8/Pico-style quick disconnect; or 150 mm (6 in.) cable with a 4-pin M12/Euro-style quick disconnect; or 150 mm (6 in.) cable with a 4-pin M8/Pico-style quick disconnect.

Construction

Black ABS/polycarbonate alloy (UL94 V-0 rated) housing, clear polycarbonate cover

IO-Link Interface

Supports Smart Sensor Profile: Yes

Baud Rate: 38,400 bps (COM2)

Process Data Width: 16 bits

IODD files: Provide all programming options of top panel interface, plus additional functionality, see [IO-Link Interface](#) on page 23

Indicators

Red 4-digit Display: Signal Level

Green 4-digit Display: Threshold

(In Program Mode, Red and Green displays are used for programming menus)

Yellow LED: Output conducting

Output Rating

100 mA maximum load (derate 1 mA per °C above 30 °C)

OFF-state leakage current: NPN/PNP models: < 5 µA at 30 V dc; **IO-Link models:** < 50 µA at 30 V dc

ON-state saturation voltage: NPN: < 1.5 V; PNP /IO-Link: < 2 V

Output Protection

Protected against output short-circuit, continuous overload, transient overvoltages, and false pulse on power-up

Output Response Time

High Speed: 200 µs

Standard: 500 µs

Long Range: 2 ms

Extra Long Range: 5 ms

Adjustments

3-way RUN/PRG/ADJ Mode Switch

2-way LO/DO Switch

3-way +/-SET/- Rocker Button

- Expert-style teaching (Two-Point and Dynamic TEACH, Light/Dark/Window/Calibration SET)
- Manually adjust sensitivity (from "+" and "-" rocker button only)
- Response Speed, TEACH Selection, Offset Percent, Auto Thresholds, Delays/Timers, Display Readout, Gain Selection, Factory Defaults (from top panel or remote input)
- Top panel interface lockout (from remote input only)

Factory Default Settings:

Setting	Factory Default
Threshold	2026
TEACH Selection	Two-Point TEACH
Response Speed	Standard: 500 µs
Offset Percent	10%
Auto Thresholds	OFF
OFF Delay	0 (Disabled)
OFF One-Shot	0 (Disabled)
ON Delay	0 (Disabled)
ON One-Shot	0 (Disabled)
Display Readout	Numeric, ECO disabled, Normal Orientation
Gain Selection	Auto Gain

Required Overcurrent Protection



WARNING: Electrical connections must be made by qualified personnel in accordance with local and national electrical codes and regulations.

Overcurrent protection is required to be provided by end product application per the supplied table.
 Overcurrent protection may be provided with external fusing or via Current Limiting, Class 2 Power Supply.
 Supply wiring leads < 24 AWG shall not be spliced.
 For additional product support, go to www.bannerengineering.com.

Supply Wiring (AWG)	Required Overcurrent Protection (Amps)
20	5.0
22	3.0
24	2.0
26	1.0
28	0.8
30	0.5

Environmental Rating

IEC IP50, NEMA 1

Operating Conditions

Temperature: -10 °C to +55 °C (+14 °F to +131 °F)
Storage Temperature: -20 °C to +85 °C (-4 °F to +185 °F)
Humidity: 90% at +60 °C maximum relative humidity (non-condensing)

Certifications



5.1 Excess Gain Curves

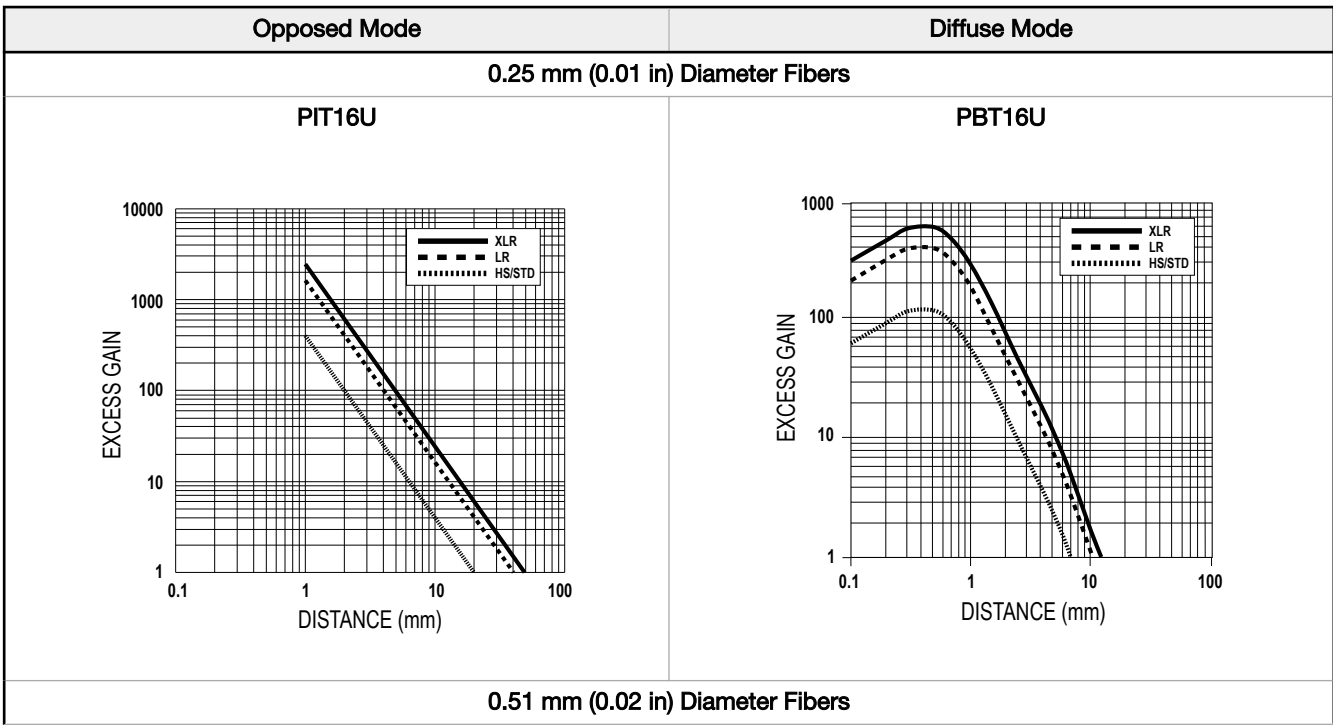

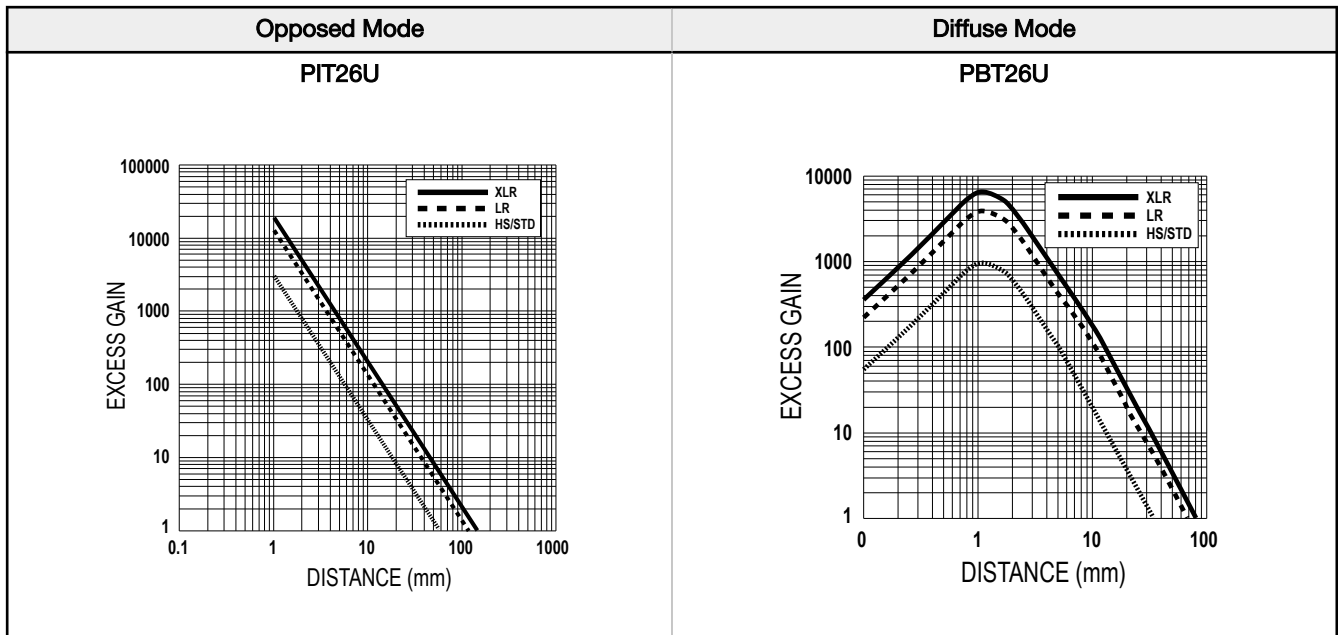

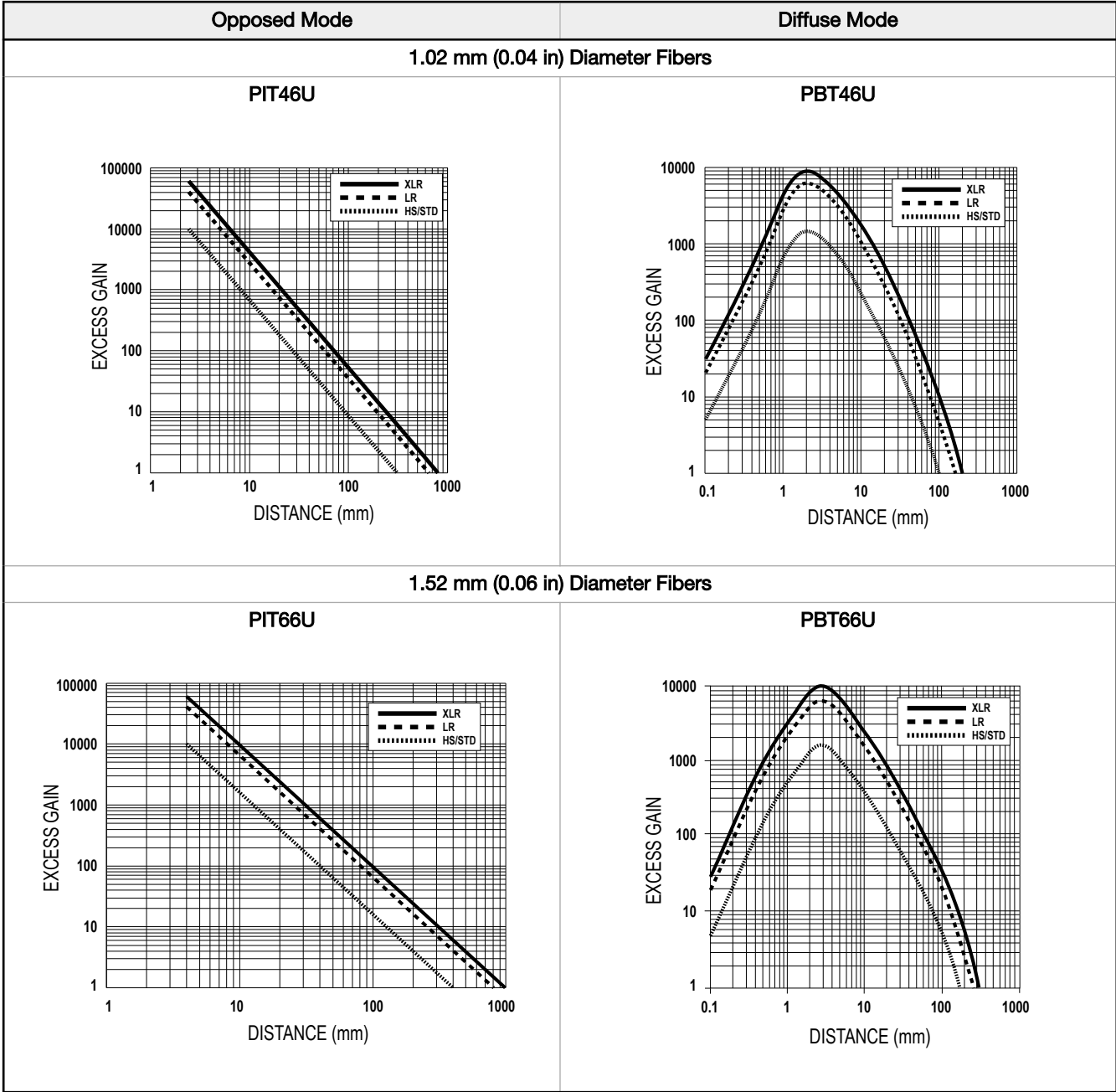

5.2 Beam Patterns

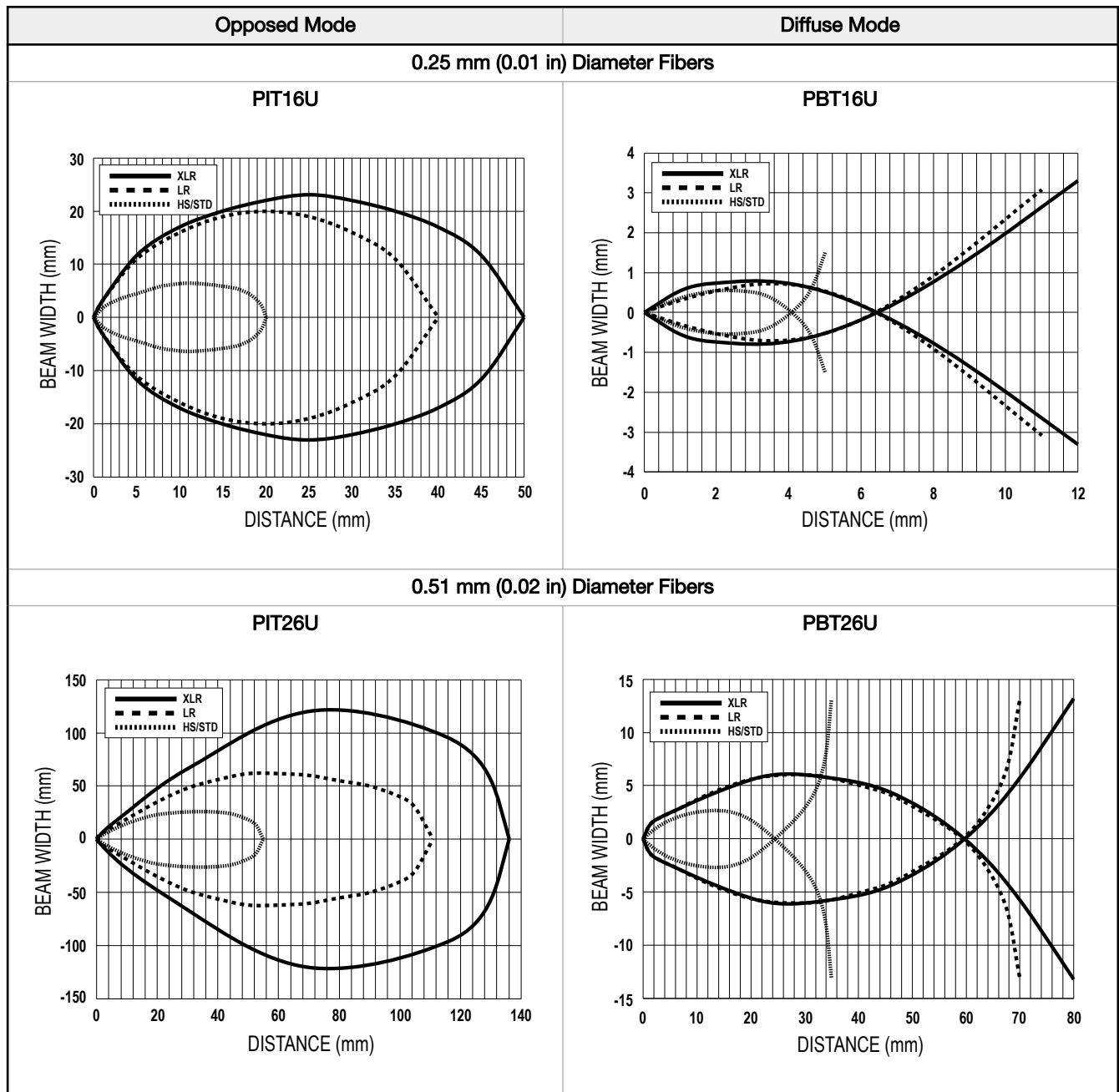

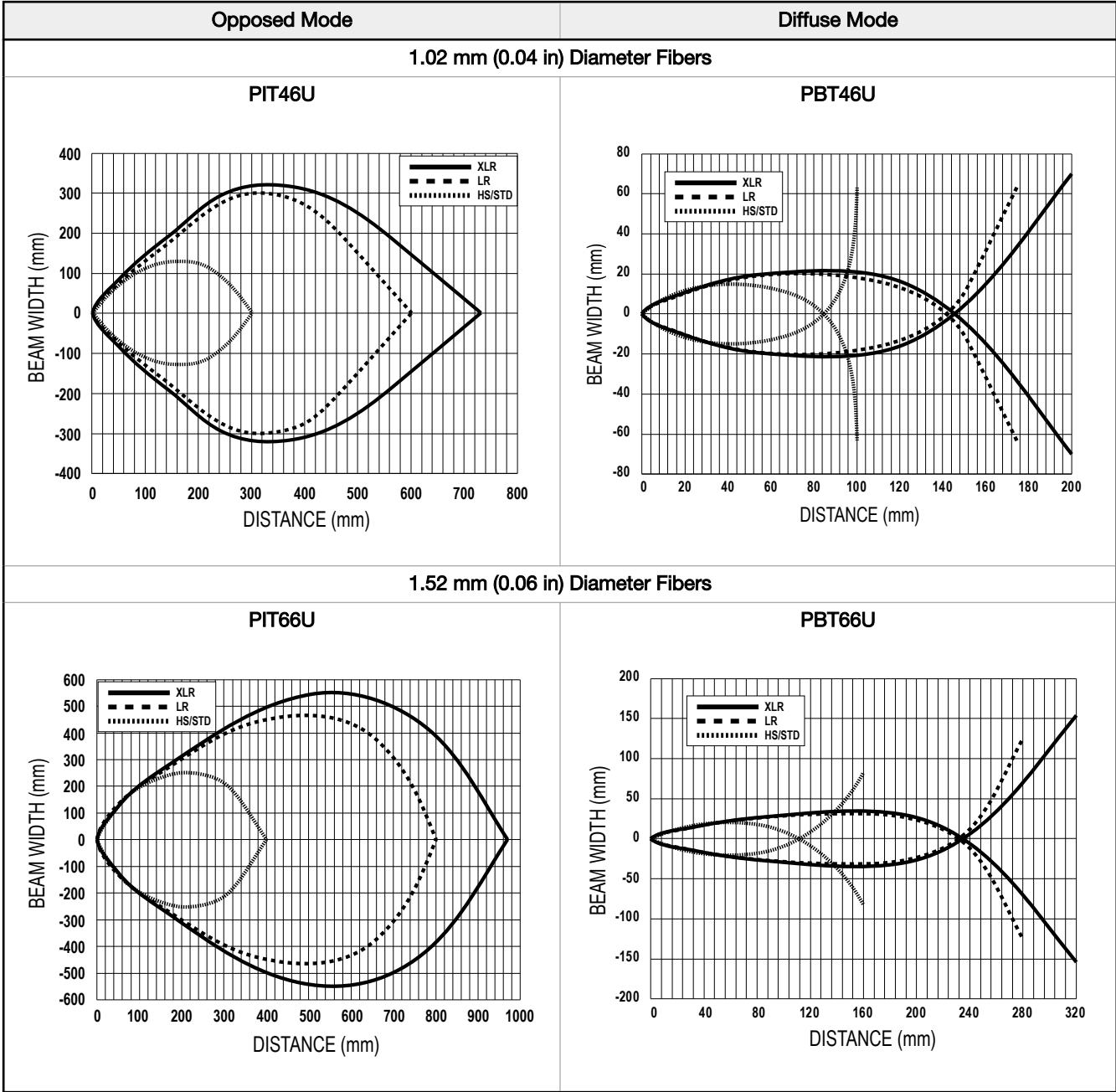

5.3 Dimensions

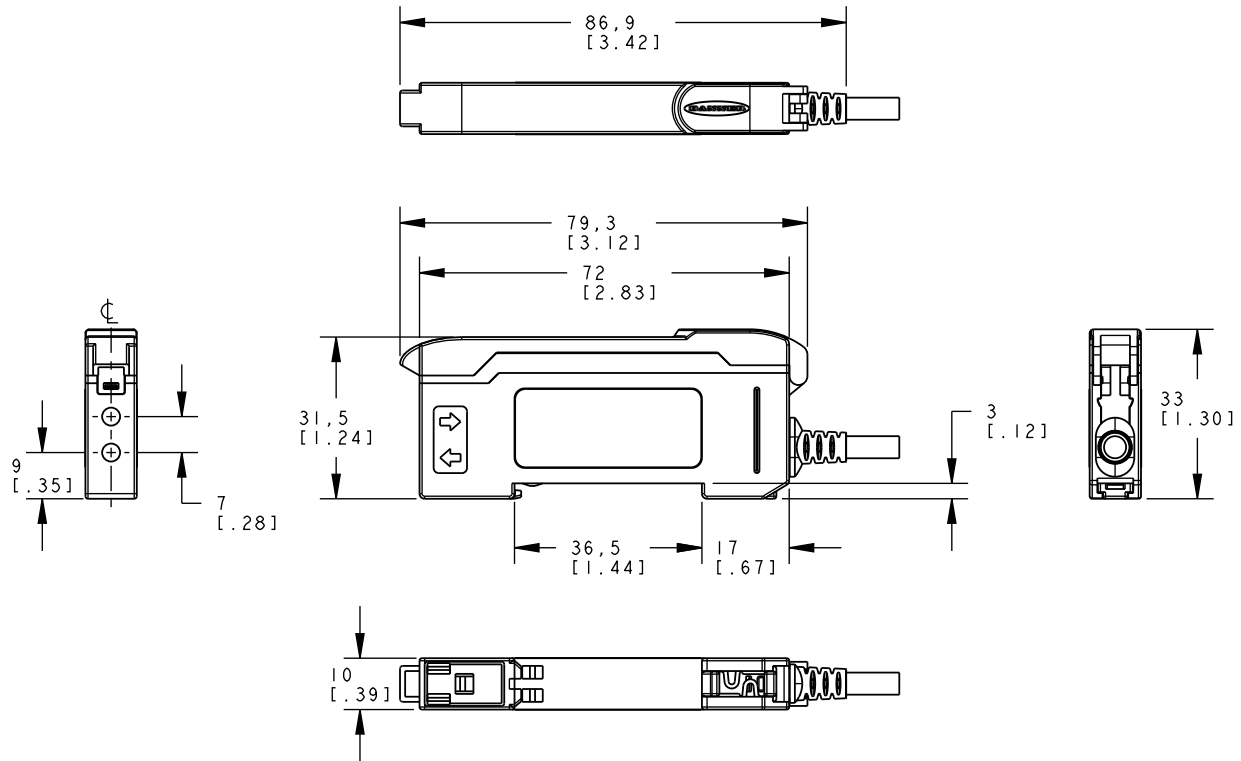

6 Accessories

DIN-35-..

35 mm DIN Rail

Model	Length
DIN-35-70	70
DIN-35-105	105
DIN-35-140	140

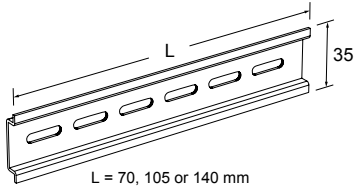

Hole center spacing: 35.1
 Hole size: 25.4 x 5.3

SA-DIN-CLAMP

- Pair of metal DIN rail end stops; slide onto DIN rail at either side of the sensor stack
- Combination (#2 Phillips, #8 standard slotted) set screw

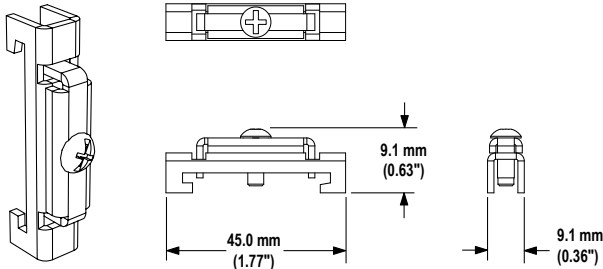

SA-DIN-BRACKET

- Plastic bracket with mounting screws

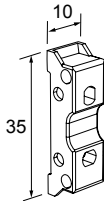

Hole center spacing: A = 16, B = 25.4, C = 15.2
 Hole size: A = \varnothing 3.2, B = \varnothing 3.3, C = \varnothing 4.4

SA-DIN-BRACKET-10

- Package of 10 plastic brackets with mounting screws

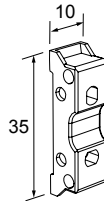





Hole center spacing: A = 16, B = 25.4, C = 15.2
 Hole size: A = \varnothing 3.2, B = \varnothing 3.3, C = \varnothing 4.4

6.1 Quick-Disconnect Cordsets

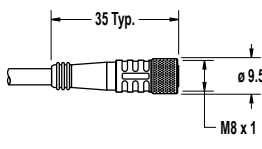
All measurements are listed in millimeters, unless noted otherwise.

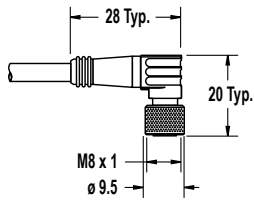
4-Pin Threaded M12/Euro-Style Cordsets—Single Ended				
Model	Length	Style	Dimensions	Pinout (Female)
MQDC-406	1.83 m (6 ft)	Straight		<p>1 = Brown 2 = White 3 = Blue 4 = Black</p>
MQDC-415	4.57 m (15 ft)			
MQDC-430	9.14 m (30 ft)			
MQDC-450	15.2 m (50 ft)	Right-Angle		
MQDC-406RA	1.83 m (6 ft)			
MQDC-415RA	4.57 m (15 ft)			
MQDC-430RA	9.14 m (30 ft)			
MQDC-450RA	15.2 m (50 ft)			

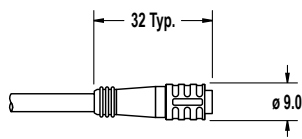
4-Pin Threaded M8/Pico-Style Cordsets—Single Ended				
Model	Length	Style	Dimensions	Pinout (Female)
PKG4M-2	2 m (6.56 ft)	Straight		 <p>1 = Brown 2 = White 3 = Blue 4 = Black</p>
PKG4M-5	5 m (16.4 ft)			
PKG4M-9	9 m (29.5 ft)			
PKW4M-2	2 m (6.56 ft)	Right Angle		
PKW4M-5	5 m (16.4 ft)			
PKW4M-9	9 m (29.5 ft)			

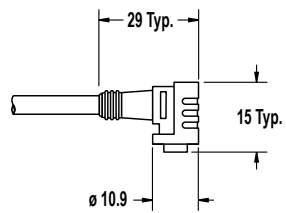
4-Pin Snap-on M8/Pico-Style Cordsets—Single Ended				
Model	Length	Style	Dimensions	Pinout (Female)
PKG4-2	2 m (6.6 ft)	Straight		 <p>1 = Brown 2 = White 3 = Blue 4 = Black</p>
PKG4-5	5 m (16.4 ft)			
PKG4-10	10 m (32.8 ft)			
PKW4Z-2	2 m (6.6 ft)	Right-Angle		
PKW4Z-5	5 m (16.4 ft)			

7 Banner Engineering Corp. Limited Warranty

Banner Engineering Corp. warrants its products to be free from defects in material and workmanship for one year following the date of shipment. Banner Engineering Corp. will repair or replace, free of charge, any product of its manufacture which, at the time it is returned to the factory, is found to have been defective during the warranty period. This warranty does not cover damage or liability for misuse, abuse, or the improper application or installation of the Banner product.

THIS LIMITED WARRANTY IS EXCLUSIVE AND IN LIEU OF ALL OTHER WARRANTIES WHETHER EXPRESS OR IMPLIED (INCLUDING, WITHOUT LIMITATION, ANY WARRANTY OF MERCHANTABILITY OR FITNESS FOR A PARTICULAR PURPOSE), AND WHETHER ARISING UNDER COURSE OF PERFORMANCE, COURSE OF DEALING OR TRADE USAGE.

This Warranty is exclusive and limited to repair or, at the discretion of Banner Engineering Corp., replacement. **IN NO EVENT SHALL BANNER ENGINEERING CORP. BE LIABLE TO BUYER OR ANY OTHER PERSON OR ENTITY FOR ANY EXTRA COSTS, EXPENSES, LOSSES, LOSS OF PROFITS, OR ANY INCIDENTAL, CONSEQUENTIAL OR SPECIAL DAMAGES RESULTING FROM ANY PRODUCT DEFECT OR FROM THE USE OR INABILITY TO USE THE PRODUCT, WHETHER ARISING IN CONTRACT OR WARRANTY, STATUTE, TORT, STRICT LIABILITY, NEGLIGENCE, OR OTHERWISE.**

Banner Engineering Corp. reserves the right to change, modify or improve the design of the product without assuming any obligations or liabilities relating to any product previously manufactured by Banner Engineering Corp. Any misuse, abuse, or improper application or installation of this product or use of the product for personal protection applications when the product is identified as not intended for such purposes will void the product warranty. Any modifications to this product without prior express approval by Banner Engineering Corp will void the product warranties. All specifications published in this document are subject to change; Banner reserves the right to modify product specifications or update documentation at any time. Specifications and product information in English supersede that which is provided in any other language. For the most recent version of any documentation, refer to: www.bannerengineering.com.

For patent information, see www.bannerengineering.com/patents.