

## Optem<sup>®</sup> FUSION Micro-Imaging Lens System Visible to SWIR (400-1700nm)

Covering the optical, mechanical,  
and operational parameters of  
FUSION system components.

*Now Supports Key Visible, NIR and SWIR wavebands*

*6th Edition*



# Table of Contents

## HOW TO USE THIS GUIDE

Configuring your Optem FUSION Lens System now with  compatibility ..... 3

## LENS SYSTEM COMPONENT OPTIONS

Optem FUSION Component Matrix.....4-5

## OPTICAL PERFORMANCE CHARTS

Fixed Magnification ..... 6-7

Fixed w/Mini Tube Magnification ..... 8-9

Fixed Magnification w/ LWD Objectives..... 10-11

Fixed Magnification w/Mini Tube w/ LWD Objectives..... 12-13

7:1 Zoom with Lower Lens ..... 14-15

7:1 Zoom w/Mini Tube with Lower Lens ..... 16-17

7:1 Zoom w/ LWD Objectives..... 18-19

7:1 Zoom w/Mini Tube w/ LWD Objectives..... 20-21

12.5:1 Zoom and Fetura+ with Lower Lens..... 22-23

12.5:1 Zoom and Fetura+ w/Mini Tube with Lower Lens..... 24-25

12.5:1 Zoom and Fetura+ w/ LWD Objectives ..... 26-27

12.5:1 Zoom and Fetura+ w/Mini Tube w/ LWD Objectives ..... 28-29

Wide Angle Lens with Lower Lens ..... 30-31

Fixed Zoom and 7:1 Zoom with  compatibility..... 32-33

FUSION Flexibility and Notes ..... 34-35



# How to use this guide

Optem FUSION is a modular Lens System, which can be modified to affect form, function and performance across the Visible (400-700nm), the Near Infrared (NIR – 700-1100nm), and the Short-Wave Infrared (SWIR – 900-1700nm) wavebands. Follow the steps outlined herein to configure an Optem FUSION Lens System to meet your specific optical, functional and physical configuration requirements. Refer to the **Optical Performance Chart** that matches your chosen Fixed-magnification or Zoom configuration (e.g., with or without Objectives, with Standard or Mini Camera Tubes). Following the flow lines in the **FUSION Component Matrix** (p. 4-5), you can identify the components you will require to configure the lens performance you desire.

**1** The first step in configuring your Optem FUSION Lens System is to determine whether you require a fixed field-of-view or a zoom system and what your desired operating wavelength will be (from Visible to SWIR). If you require zoom, determine how much zoom range you require, 7:1 or 12.5:1. This decision will direct you to the correct FUSION **Optical Performance chart** (p. 06 - 33).

**2** Your second choice is determining what working distance you require for your system. Specify the correct Lower Lens to best fit your working distance requirements. Working distance is the mechanical space between the bottom of the lens system and your specimen. The addition of a ringlight or right-angle module to the bottom of the system will further reduce this working distance. Using the shortest working distance will provide the best resolution for all systems. Choose longer working distances when necessary to increase your desired field-of-view. Working distances for each Lower

Lens is listed just below the Lower Lenses shown across the top of each **Optical Performance chart**. You need to know your intended camera format (chip size) to determine the field-of-view for your lens system. If you do not have a particular camera format in mind, use the numbers in the chart to help you determine the best camera chip size selection for your Optem FUSION Lens System.

**3** Navigate from the top of the **Component Matrix** down to the Lower Lenses to identify the components needed to complete your FUSION Lens System. Fixed Magnification systems require the Aperture Module 35-07-20-000 for best performance. The correct aperture diameter is provided in the **Fixed Optical Performance Chart** (p. 07 - 13 and p.32).

These steps above are a general guide in configuring your Lens System. Your application may require choosing components in a different order than detailed herein. In this case, refer to the appropriate **Optical Performance chart** and identify your desired parameters (typically field-of-view at high- and low-end zoom) as it relates to your intended camera format.

## NOTE:

- Now including Optical Performance Charts for FUSION  systems (p. 32-33).
- With the Optem FUSION System, the optical magnification is the product of the magnification of the Lower Lens, Zoom dial setting (if Zoom and the magnification of the Camera Tube. This formula works even when using Qioptiq Microscope Objectives.

*Contact your Qioptiq representative or your Qioptiq dealer for additional help determining your specific requirements.*

### ACCESSORIES

**35-07-01-000**  
50/50 CUBE

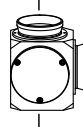

**35-07-00-000**  
MIRROR CUBE

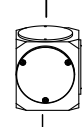

**35-07-02-000**  
MIRROR CUBE ADAPTER

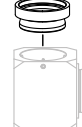

NOTE: 35-07-11 USES 65mm WORKING DISTANCE WHEN USED BELOW LOWER LENS. USE THIS COMBINATION WHEN PLACING RIGHT ANGLE BELOW SYSTEM. REMOVE DOVETAIL TO INCREASE WORKING DISTANCE.

**35-07-11-000**  
INLINE MOUNT



**35-07-21-000**  
25.4MM FILTER HOLDER



**35-07-20-000**  
APERTURE SET



**35-07-25-000**  
ADJUSTABLE IRIS



**35-07-04-000**  
FLUORESCENCE CUBE HOLDER UPPER  
(NOTE: USES ZEISS TYPE 91029 CUBE)



**35-03-50-000**  
TUNABLE LENS FOCUS MODULE  
(NOTE: ATTACH DIRECTLY ABOVE LOWER FUNCTION MODULE ONLY)



**NOTE: NOT EVERY COMBINATION WILL PRESENT DESIRED RESULTS.**

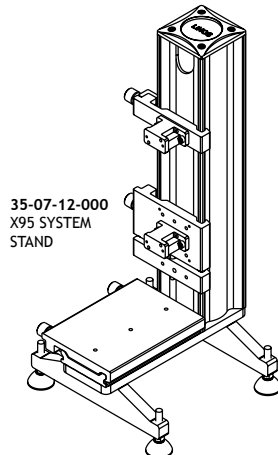

### CAMERA



### CAMERA MOUNTS

**25-60-23-000**  
EOS CAMERA MOUNT



**25-60-24-000**  
F CAMERA MOUNT



**35-08-70-000**  
C \ CS CAMERA MOUNT



**25-60-26-000**  
4/3 CAMERA MOUNT



### CAMERA TUBES

**35-08-00-000**  
CAMERA TUBE  
0.4X \ 80 FL



**35-08-01-000**  
CAMERA TUBE  
0.5X \ 100 FL



**35-08-02-000**  
CAMERA TUBE  
0.6X \ 120 FL



**35-08-04-000**  
CAMERA TUBE  
0.8X \ 160 FL



**35-08-06-000**  
CAMERA TUBE  
1X \ 200 FL



**35-08-11-000**  
MINI CAMERA TUBE  
0.8X \ 160 FL



### ACCESSORIES

**35-07-10-000**  
CAMERA TUBE CLAMP

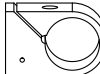

#### 7:1 ZOOM

**35-31-10-000**  
7:1 ZOOM MANUAL



**35-31-40-000**  
7:1 ZOOM MANUAL DETENT



**35-31-60-000**  
7:1 ZOOM STEPPER MOTORIZED

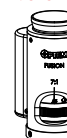

#### FIXED MAGNIFICATION

**35-07-20-000**  
APERTURE SET  
REQUIRED FOR FIXED MAGNIFICATION SYSTEMS



**A CONTROL**

**SWIR**

**NOTE:**

- Products listed in **RED TYPE** Indicate **SWIR** version available.
- For ordering purposes, **VISIBLE** components are identified by a "35" prefix, while **SWIR** components use a "45" e.g. 35-XX-XX-XXX VISIBLE, and 45-YY-YY-YYY SWIR
- All "35-XX" modules are compatible with one another; and all "45-YY" modules are compatible with one another.
- Using "35-XX" and "45-YY" modules with one another is not recommended.
- Non-optics mounts/modules are cross-compatible between VISIBLE and **SWIR**

### LOWER FUNCTION MODULES

**35-03-10-000**  
15mm FOCUS MANUAL



**35-03-30-000**  
15mm FOCUS STEPPER MOTOR

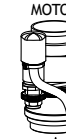

**35-07-03-000**  
FLUORESCENT CUBE HOLDER LOWER



NOTE: USES ZEISS TYPE 91029 CUBE. USE WITH 35-01-00-000 BASIC LOWER FUNCTION MODULE RECOMMENDED.

**B CONTROL**

**ILLUMINATION**

**35-01-00-000**  
BASIC



### LOWER LENSES

**35-00-11-000**  
0.4X \ 500 FL



**35-00-10-000**  
0.5X \ 400 FL



**35-00-09-000**  
0.67X \ 300 FL



**35-00-08-000**  
1X \ 200 FL



**35-00-06-000**  
1.25X \ 160 FL



**35-00-03-000**  
2X \ 100 FL



**42-30-41-000**  
INFINITY MACRO LENS



**ILLUMINATION**

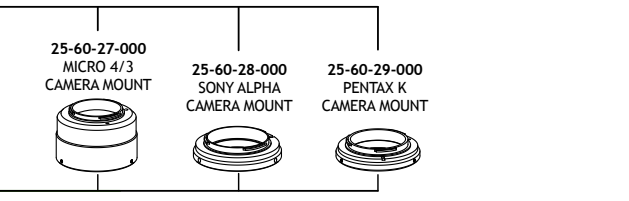

**MINI CAMERA TUBES**

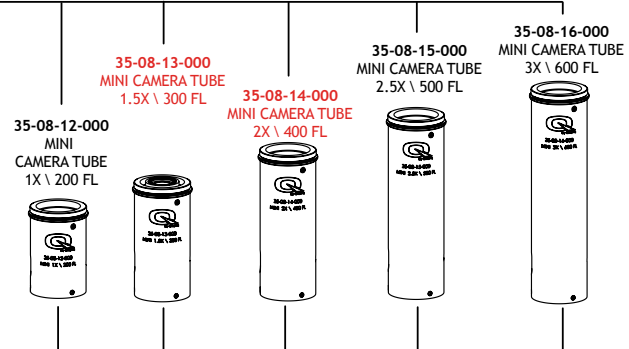

**12.5:1 ZOOM**

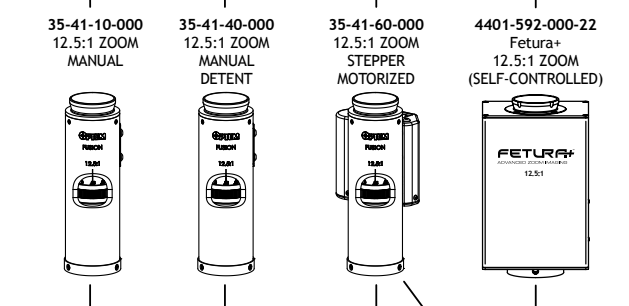

**ACCESSORIES**

**A CONTROL**

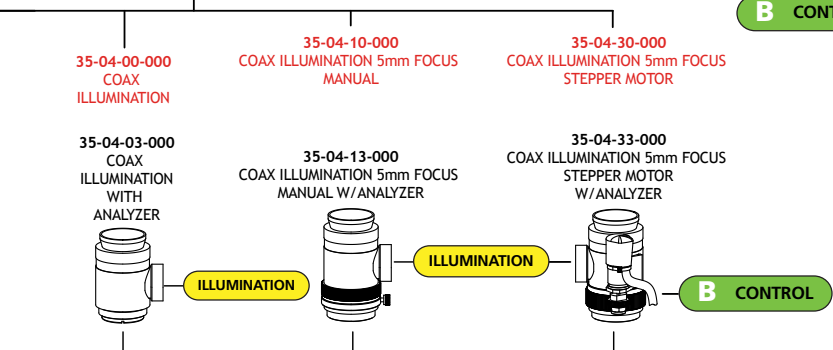

**ACCESSORIES**

**ILLUMINATION**

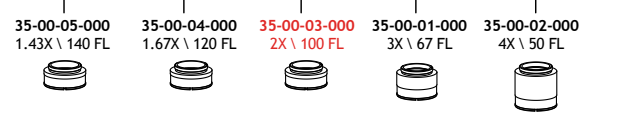

NOTE: COAX ILLUMINATION HAS LIMITED FIELD ILLUMINATION WITH LARGE FOVS.

**LIGHTING ACCESSORIES**

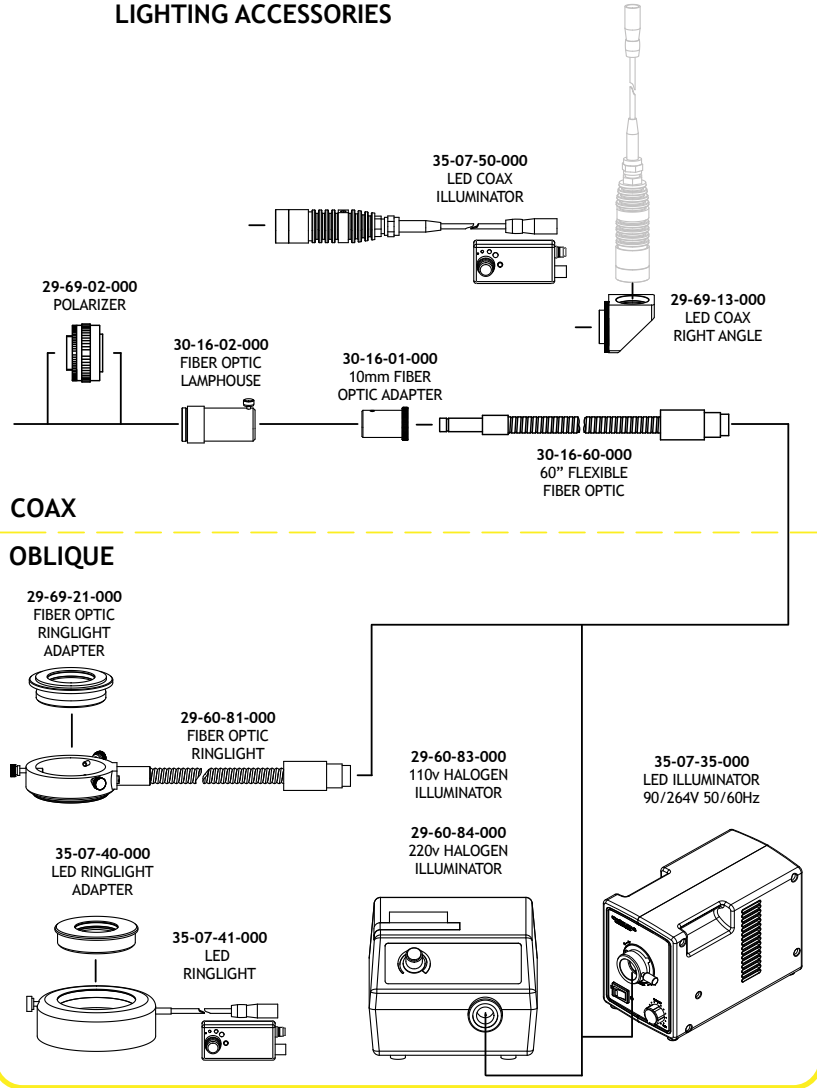

**A CONTROL**

**B CONTROL**

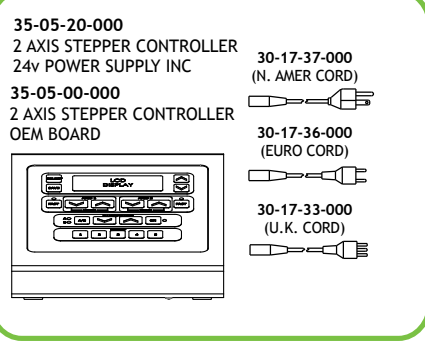

**LWD OBJECTIVES**

- 28-21-02-001 2X M PLAN APO
- 28-21-05-001 5X M PLAN APO
- 28-21-10-000 10X M PLAN APO
- 28-21-11-001 20X M PLAN APO
- 28-21-50-001 50X M PLAN APO

- 28-20-44-000 5X HI-RES
- 28-20-45-000 10X HI-RES
- 28-20-46-000 20X HI-RES

CERTAIN LIMITATIONS APPLY WITH HI-RES OBJECTIVES. SEE BROCHURE FOR DETAILS.

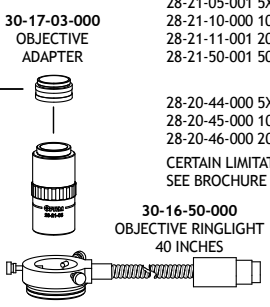

# Optical Performance - Fixed Magnification with Lower

## Chart 1A

		<b>0.4X Lower Lens</b> 35-00-11-000 WD: 490mm EFL: 500mm			<b>0.5X Lower Lens</b> 35-00-10-000 WD: 390mm EFL: 400mm			<b>0.67X Lower Lens</b> 35-00-09-000 WD: 290mm EFL: 300mm			<b>1X Lower Lens</b> 35-00-08-000 WD: 190mm EFL: 200mm			
<b>Max FOV Dia.</b>		100			80			60			40			
<b>Max Coax FOV Dia.</b>		13			13			14			12			
<b>0.4X Camera Tube</b> 35-08-00-000 EFL: 80mm <b>5mm Stop</b>	<b>NA</b>	0.0050			0.0063			0.0083			0.013			
	<b>Res (lp/mm)</b>	15			19			25			38			
	<b>Mag</b>	0.16			0.20			0.27			0.40			
	<b>DOF (mm)</b>	23			15			8.2			3.6			
	<b>FOV (mm) Cam Format</b>	<b>1/3"</b>	23	x	30	18	x	24	14	x	18	9.0	x	12
		<b>1/2"</b>	30	x	40	24	x	32	18	x	24	12	x	16
		<b>2/3"</b>	41	x	55	33	x	44	25	x	33	17	x	22
<b>0.5X Camera Tube</b> 35-08-01-000 EFL: 100mm <b>5mm Stop</b>	<b>NA</b>	0.0050			0.0063			0.0083			0.013			
	<b>Res (lp/mm)</b>	15			19			25			38			
	<b>Mag</b>	0.20			0.25			0.33			0.50			
	<b>DOF (mm)</b>	23			15			8.2			3.6			
	<b>FOV (mm) Cam Format</b>	<b>1/3"</b>	18	x	24	14	x	19	11	x	14	7.2	x	9.6
		<b>1/2"</b>	24	x	32	19	x	26	14	x	19	9.6	x	13
		<b>2/3"</b>	33	x	44	26	x	35	20	x	26	13	x	18
<b>0.6X Camera Tube</b> 35-08-02-000 EFL: 120mm <b>8mm Stop</b>	<b>NA</b>	0.0080			0.010			0.013			0.020			
	<b>Res (lp/mm)</b>	24			30			40			60			
	<b>Mag</b>	0.24			0.30			0.40			0.60			
	<b>DOF (mm)</b>	8.9			5.7			3.2			1.4			
	<b>FOV (mm) Cam Format</b>	<b>1/3"</b>	15	x	20	12	x	16	9.0	x	12	6.0	x	8.0
		<b>1/2"</b>	20	x	27	16	x	21	12	x	16	8.0	x	11
		<b>2/3"</b>	28	x	37	22	x	29	17	x	22	11	x	15
<b>0.8X Camera Tube</b> 35-08-04-000 EFL: 160mm <b>12mm Stop</b>	<b>NA</b>	0.012			0.015			0.020			0.030			
	<b>Res (lp/mm)</b>	36			45			60			90			
	<b>Mag</b>	0.32			0.40			0.53			0.80			
	<b>DOF (mm)</b>	3.9			2.5			1.4			0.63			
	<b>FOV (mm) Cam Format</b>	<b>1/3"</b>	11	x	15	9.0	x	12	6.8	x	9.0	4.5	x	6.0
		<b>1/2"</b>	15	x	20	12	x	16	9.0	x	12	6.0	x	8.0
		<b>2/3"</b>	21	x	28	17	x	22	12	x	17	8.3	x	11
<b>1X Camera Tube</b> 35-08-06-000 EFL: 200mm <b>18mm Stop</b>	<b>NA</b>	0.018			0.023			0.030			0.045			
	<b>Res (lp/mm)</b>	54			68			90			135			
	<b>Mag</b>	0.40			0.50			0.67			1.0			
	<b>DOF (mm)</b>	1.8			1.1			0.63			0.28			
	<b>FOV (mm) Cam Format</b>	<b>1/3"</b>	9.0	x	12	7.2	x	9.6	5.4	x	7.2	3.6	x	4.8
		<b>1/2"</b>	12	x	16	9.6	x	13	7.2	x	9.6	4.8	x	6.4
		<b>2/3"</b>	17	x	22	13	x	18	9.9	x	13	6.6	x	8.8

 -- Useable FOV Limited by Coax illumination (>50% Illumination)

 -- FOV Limited by vignetting

# Lenses

<b>1.25X</b> <b>Lower Lens</b> 35-00-06-000 WD: 155mm EFL: 160mm	<b>1.43X</b> <b>Lower Lens</b> 35-00-05-000 WD: 135mm EFL: 140mm	<b>1.67</b> <b>Lower Lens</b> 35-00-04-000 WD: 110mm EFL: 120mm	<b>2X</b> <b>Lower Lens</b> 35-00-03-000 WD: 95mm EFL: 100mm	<b>3X</b> <b>Lower Lens</b> 35-00-01-000 WD: 50mm EFL: 67mm	<b>4X</b> <b>Lower Lens</b> 35-00-02-000 WD: 32mm EFL: 50mm
32	28	24	20	15	10
12	13	14	15	15	10
0.016	0.018	0.021	0.025	0.037	0.050
47	54	63	75	112	150
0.50	0.57	0.67	0.80	1.2	1.6
2.3	1.8	1.3	0.91	0.40	0.23
7.2 x 9.6	6.3 x 8.4	5.4 x 7.2	4.5 x 6.0	3.0 x 4.0	2.3 x 3.0
9.6 x 13	8.4 x 11	7.2 x 9.6	6.0 x 8.0	4.0 x 5.3	3.0 x 4.0
13 x 18	12 x 15	9.9 x 13	8.3 x 11	5.5 x 7.3	4.1 x 5.5
0.016	0.018	0.021	0.025	0.037	0.050
47	54	63	75	112	150
0.63	0.71	0.83	1.0	1.5	2.0
2.3	1.8	1.3	0.91	0.40	0.23
5.8 x 7.7	5.0 x 6.7	4.3 x 5.8	3.6 x 4.8	2.4 x 3.2	1.8 x 2.4
7.7 x 10	6.7 x 9.0	5.8 x 7.7	4.8 x 6.4	3.2 x 4.3	2.4 x 3.2
11 x 14	9.2 x 12	7.9 x 11	6.6 x 8.8	4.4 x 5.9	3.3 x 4.4
0.025	0.029	0.033	0.040	0.060	0.080
75	86	100	120	180	240
0.75	0.86	1.0	1.2	1.8	2.4
0.91	0.69	0.51	0.35	0.16	0.089
4.8 x 6.4	4.2 x 5.6	3.6 x 4.8	3.0 x 4.0	2.0 x 2.7	1.5 x 2.0
6.4 x 8.5	5.6 x 7.5	4.8 x 6.4	4.0 x 5.3	2.7 x 3.6	2.0 x 2.7
8.8 x 12	7.7 x 10	6.6 x 8.8	5.5 x 7.3	3.7 x 4.9	2.8 x 3.7
0.038	0.043	0.050	0.060	0.090	0.12
113	129	150	180	270	360
1.0	1.1	1.3	1.6	2.4	3.2
0.40	0.31	0.23	0.16	0.070	0.039
3.6 x 4.8	3.2 x 4.2	2.7 x 3.6	2.3 x 3.0	1.5 x 2.0	1.1 x 1.5
4.8 x 6.4	4.2 x 5.6	3.6 x 4.8	3.0 x 4.0	2.0 x 2.7	1.5 x 2.0
6.6 x 8.8	5.8 x 7.7	5.0 x 6.6	4.1 x 5.5	2.8 x 3.7	2.1 x 2.8
0.056	0.064	0.075	0.090	0.13	0.18
169	193	225	270	405	540
1.25	1.43	1.67	2.0	3.0	4.0
0.18	0.14	0.10	0.070	0.031	0.018
2.9 x 3.8	2.5 x 3.4	2.2 x 2.9	1.8 x 2.4	1.2 x 1.6	0.90 x 1.2
3.8 x 5.1	3.4 x 4.5	2.9 x 3.8	2.4 x 3.2	1.6 x 2.1	1.2 x 1.6
5.3 x 7.0	4.6 x 6.2	4.0 x 5.3	3.3 x 4.4	2.2 x 2.9	1.7 x 2.2

# Optical Performance - Fixed Magnification with Lower

## Chart 1B

		<b>0.4X Lower Lens</b> 35-00-11-000 WD: 490mm EFL: 500mm			<b>0.5X Lower Lens</b> 35-00-10-000 WD: 390mm EFL: 400mm			<b>0.67X Lower Lens</b> 35-00-09-000 WD: 290mm EFL: 300mm			<b>1X Lower Lens</b> 35-00-08-000 WD: 190mm EFL: 200mm		
<b>Max FOV Dia.</b>		100			80			60			40		
<b>Max Coax FOV Dia.</b>		13			13			14			12		
<b>1.5X Mini Camera Tube</b>  35-08-13-000 EFL: 300mm  <b>12mm Stop</b>	<b>NA</b>	0.012			0.015			0.020			0.030		
	<b>Res (lp/mm)</b>	36			45			60			90		
	<b>Mag</b>	0.60			0.75			1.0			1.5		
	<b>DOF (mm)</b>	3.9			2.5			1.4			0.63		
	<b>FOV (mm)</b> <b>Cam Format</b>	<b>2/3"</b>	11	x	15	8.8	x	12	6.6	x	8.8	4.4	x
	<b>1"</b>	16	x	21	13	x	17	9.6	x	13	6.4	x	8.5
	<b>4/3"</b>	23	x	30	18	x	24	14	x	18	9.0	x	12
	<b>APS-C</b>	28	x	42	22	x	33	17	x	25	11	x	17
<b>2X Mini Camera Tube</b>  35-08-14-000 EFL: 400mm  <b>18mm Stop</b>	<b>NA</b>	0.018			0.023			0.030			0.045		
	<b>Res (lp/mm)</b>	54			68			90			135		
	<b>Mag</b>	0.80			1.0			1.3			2.0		
	<b>DOF (mm)</b>	1.8			1.1			0.63			0.28		
	<b>FOV (mm)</b> <b>Cam Format</b>	<b>2/3"</b>	8.3	x	11	6.6	x	8.8	5.0	x	6.6	3.3	x
	<b>1"</b>	12	x	16	9.6	x	13	7.2	x	9.6	4.8	x	6.4
	<b>4/3"</b>	17	x	23	14	x	18	10	x	14	6.8	x	9.0
	<b>APS-C</b>	21	x	31	17	x	25	13	x	19	8.4	x	13
<b>2.5X Mini Camera Tube</b>  35-08-15-000 EFL: 500mm  <b>18mm Stop</b>	<b>NA</b>	0.018			0.023			0.030			0.045		
	<b>Res (lp/mm)</b>	54			68			90			135		
	<b>Mag</b>	1.0			1.3			1.7			2.5		
	<b>DOF (mm)</b>	1.8			1.1			0.63			0.28		
	<b>FOV (mm)</b> <b>Cam Format</b>	<b>1"</b>	9.6	x	13	7.7	x	10	5.8	x	7.7	3.8	x
	<b>4/3"</b>	14	x	18	11	x	14	8.1	x	11	5.4	x	7.2
	<b>APS-C</b>	17	x	25	13	x	20	10	x	15	6.7	x	10
	<b>35mm (FULL)</b>	24	x	36	19	x	29	14	x	22	9.6	x	14
<b>3X Mini Camera Tube</b>  35-08-16-000 EFL: 600mm  <b>18mm Stop</b>	<b>NA</b>	0.018			0.023			0.030			0.045		
	<b>Res (lp/mm)</b>	54			68			90			135		
	<b>Mag</b>	1.2			1.5			2.0			3.0		
	<b>DOF (mm)</b>	1.8			1.1			0.63			0.28		
	<b>FOV (mm)</b> <b>Cam Format</b>	<b>1"</b>	8.0	x	11	6.4	x	8.5	4.8	x	6.4	3.2	x
	<b>4/3"</b>	11	x	15	9.0	x	12	6.8	x	9.0	4.5	x	6.0
	<b>APS-C</b>	14	x	21	11	x	17	8.4	x	13	5.6	x	8.4
	<b>35mm (FULL)</b>	20	x	30	16	x	24	12	x	18	8.0	x	12

- Useable FOV Limited by Coax illumination (>50% Illumination)
- FOV Limited by vignetting

	Height	x	Width	Diag.
<b>2/3"</b>	6.6	x	8.8	11
<b>1"</b>	9.6	x	12.8	16
<b>4/3"</b>	13.5	x	18	22.5
<b>APS-C*</b>	16.7	x	25.1	30
<b>35mm (Full)</b>	24	x	36	43.3

\*Also known as Half Frame 35mm format



# Lenses - Mini Camera Tubes

<b>1.25X</b> <b>Lower Lens</b> 35-00-06-000 WD: 155mm EFL: 160mm	<b>1.43X</b> <b>Lower Lens</b> 35-00-05-000 WD: 135mm EFL: 140mm	<b>1.67</b> <b>Lower Lens</b> 35-00-04-000 WD: 110mm EFL: 120mm	<b>2X</b> <b>Lower Lens</b> 35-00-03-000 WD: 95mm EFL: 100mm	<b>3X</b> <b>Lower Lens</b> 35-00-01-000 WD: 50mm EFL: 67mm	<b>4X</b> <b>Lower Lens</b> 35-00-02-000 WD: 32mm EFL: 50mm
32	28	24	20	15	10
12	13	14	15	15	10
0.038	0.043	0.050	0.060	0.090	0.12
113	129	150	180	270	360
1.9	2.1	2.5	3.0	4.5	6.0
0.40	0.31	0.23	0.16	0.070	0.039
3.5 x 4.7	3.1 x 4.1	2.6 x 3.5	2.2 x 2.9	1.5 x 2.0	1.1 x 1.5
5.1 x 6.8	4.5 x 6.0	3.8 x 5.1	3.2 x 4.3	2.1 x 2.8	1.6 x 2.1
7.2 x 9.6	6.3 x 8.4	5.4 x 7.2	4.5 x 6.0	3.0 x 4.0	2.3 x 3.0
8.9 x 13	7.8 x 12	6.7 x 10	5.6 x 8.4	3.7 x 5.6	2.8 x 4.2
0.056	0.064	0.075	0.090	0.13	0.18
169	193	225	270	405	540
2.5	2.9	3.3	4.0	6.0	8.0
0.18	0.14	0.101	0.070	0.031	0.018
2.6 x 3.5	2.3 x 3.1	2.0 x 2.6	1.7 x 2.2	1.1 x 1.5	0.83 x 1.1
3.8 x 5.1	3.4 x 4.5	2.9 x 3.8	2.4 x 3.2	1.6 x 2.1	1.2 x 1.6
5.4 x 7.2	4.7 x 6.3	4.1 x 5.4	3.4 x 4.5	2.3 x 3.0	1.7 x 2.3
6.7 x 10	5.8 x 8.8	5.0 x 7.5	4.2 x 6.3	2.8 x 4.2	2.1 x 3.1
0.056	0.064	0.075	0.090	0.13	0.18
169	193	225	270	405	540
3.1	3.6	4.2	5.0	7.5	10
0.18	0.14	0.10	0.070	0.031	0.018
3.1 x 4.1	2.7 x 3.6	2.3 x 3.1	1.9 x 2.6	1.3 x 1.7	0.96 x 1.3
4.3 x 5.8	3.8 x 5.0	3.2 x 4.3	2.7 x 3.6	1.8 x 2.4	1.4 x 1.8
5.3 x 8.0	4.7 x 7.0	4.0 x 6.0	3.3 x 5.0	2.2 x 3.3	1.7 x 2.5
7.7 x 12	6.7 x 10	5.8 x 8.6	4.8 x 7.2	3.2 x 4.8	2.4 x 3.6
0.056	0.064	0.075	0.090	0.13	0.18
169	193	225	270	405	540
3.8	4.3	5.0	6.0	9.0	12
0.18	0.14	0.10	0.070	0.031	0.018
2.6 x 3.4	2.2 x 3.0	1.9 x 2.6	1.6 x 2.1	1.1 x 1.4	0.80 x 1.1
3.6 x 4.8	3.2 x 4.2	2.7 x 3.6	2.3 x 3.0	1.5 x 2.0	1.1 x 1.5
4.5 x 6.7	3.9 x 5.9	3.3 x 5.0	2.8 x 4.2	1.9 x 2.8	1.4 x 2.1
6.4 x 9.6	5.6 x 8.4	4.8 x 7.2	4.0 x 6.0	2.7 x 4.0	2.0 x 3.0

# Optical Performance - Fixed Magnification with LWD

## Chart 1C

		2X M Plan Apo 28-21-02-001 WD: 34mm			5X M Plan Apo 28-21-05-001 WD: 41mm			10X M Plan Apo 28-21-10-000 WD: 34mm			20X M Plan Apo 28-21-11-001 WD: 20mm			
Max FOV Dia.		17			16			10			5.4			
Max Coax FOV Dia.		16			11			5.0			2.6			
0.4X Camera Tube  35-08-00-000 EFL: 80mm  NO Stop	NA	0.057			0.14			0.30			0.42			
	Res (lp/mm)	170			420			900			1260			
	Mag	0.80			2.0			4.0			8.0			
	DOF (mm)	0.18			0.029			0.0063			0.0032			
	FOV (mm) Cam Format	1/3"	4.5	x	6.0	1.8	x	2.4	0.90	x	1.2	0.45	x	0.60
		1/2"	6.0	x	8.0	2.4	x	3.2	1.2	x	1.6	0.60	x	0.80
		2/3"	8.3	x	11	3.3	x	4.4	1.7	x	2.2	0.83	x	1.1
0.5X Camera Tube  35-08-01-000 EFL: 100mm  NO Stop	NA	0.057			0.14			0.30			0.42			
	Res (lp/mm)	170			420			900			1260			
	Mag	1.0			2.5			5.0			10			
	DOF (mm)	0.18			0.029			0.0063			0.0032			
	FOV (mm) Cam Format	1/3"	3.6	x	4.8	1.4	x	1.9	0.72	x	0.96	0.36	x	0.48
		1/2"	4.8	x	6.4	1.9	x	2.6	0.96	x	1.3	0.48	x	0.64
		2/3"	6.6	x	8.8	2.6	x	3.5	1.3	x	1.8	0.66	x	0.88
0.6X Camera Tube  35-08-02-000 EFL: 120mm  NO Stop	NA	0.057			0.14			0.30			0.42			
	Res (lp/mm)	170			420			900			1260			
	Mag	1.2			3.0			6.0			12			
	DOF (mm)	0.18			0.029			0.0063			0.0032			
	FOV (mm) Cam Format	1/3"	3.0	x	4.0	1.2	x	1.6	0.60	x	0.80	0.30	x	0.40
		1/2"	4.0	x	5.3	1.6	x	2.1	0.80	x	1.1	0.40	x	0.53
		2/3"	5.5	x	7.3	2.2	x	2.9	1.1	x	1.5	0.55	x	0.73
0.8X Camera Tube  35-08-04-000 EFL: 160mm  NO Stop	NA	0.057			0.14			0.30			0.42			
	Res (lp/mm)	170			420			900			1260			
	Mag	1.6			4.0			8.0			16			
	DOF (mm)	0.18			0.029			0.0063			0.0032			
	FOV (mm) Cam Format	1/3"	2.3	x	3.0	0.90	x	1.2	0.45	x	0.60	0.23	x	0.30
		1/2"	3.0	x	4.0	1.2	x	1.6	0.60	x	0.80	0.30	x	0.40
		2/3"	4.1	x	5.5	1.7	x	2.2	0.83	x	1.1	0.41	x	0.55
1X Camera Tube  35-08-06-000 EFL: 200mm  NO Stop	NA	0.057			0.14			0.30			0.42			
	Res (lp/mm)	170			420			900			1260			
	Mag	2.0			5.0			10			20			
	DOF (mm)	0.18			0.029			0.0063			0.0032			
	FOV (mm) Cam Format	1/3"	1.8	x	2.4	0.72	x	0.96	0.36	x	0.48	0.18	x	0.24
		1/2"	2.4	x	3.2	0.96	x	1.3	0.48	x	0.64	0.24	x	0.32
		2/3"	3.3	x	4.4	1.3	x	1.8	0.66	x	0.88	0.33	x	0.44

Useable FOV Limited by Coax illumination (>50% Illumination)

FOV Limited by vignetting

# Objectives

50X M Plan Apo 28-21-50-001 WD: 13mm			5X HiRes 28-20-44-000 WD: 34mm			10X HiRes 28-20-45-000 WD: 19mm			20X HiRes 28-20-46-000 WD: 13mm		
2.3			10			5.2			4.5		
1.1			7.0			2.8			2.1		
0.55			0.225			0.45			0.60		
1650			675			1350			1800		
20			2.0			4.0			8.0		
0.0019			0.011			0.0028			0.0016		
0.18	x	0.24	1.8	x	2.4	0.90	x	1.2	0.45	x	0.60
0.24	x	0.32	2.4	x	3.2	1.2	x	1.6	0.60	x	0.80
0.33	x	0.44	3.3	x	4.4	1.7	x	2.2	0.83	x	1.1
0.55			0.225			0.45			0.60		
1650			675			1350			1800		
25			2.5			5.0			10		
0.0019			0.011			0.0028			0.0016		
0.14	x	0.19	1.4	x	1.9	0.72	x	0.96	0.36	x	0.48
0.19	x	0.26	1.9	x	2.6	0.96	x	1.3	0.48	x	0.64
0.26	x	0.35	2.6	x	3.5	1.3	x	1.8	0.66	x	0.88
0.55			0.225			0.45			0.60		
1650			675			1350			1800		
30			3.0			6.0			12		
0.0019			0.011			0.0028			0.0016		
0.12	x	0.16	1.2	x	1.6	0.60	x	0.80	0.30	x	0.40
0.16	x	0.21	1.6	x	2.1	0.80	x	1.1	0.40	x	0.53
0.22	x	0.29	2.2	x	2.9	1.1	x	1.5	0.55	x	0.73
0.55			0.225			0.45			0.60		
1650			675			1350			1800		
40			4.0			8.0			16		
0.0019			0.011			0.0028			0.0016		
0.090	x	0.12	0.90	x	1.2	0.45	x	0.60	0.23	x	0.30
0.12	x	0.16	1.2	x	1.6	0.60	x	0.80	0.30	x	0.40
0.17	x	0.22	1.7	x	2.2	0.83	x	1.1	0.41	x	0.55
0.55			0.225			0.45			0.60		
1650			675			1350			1800		
50			5.0			10			20		
0.0019			0.011			0.0028			0.0016		
0.072	x	0.096	0.72	x	0.96	0.36	x	0.48	0.18	x	0.24
0.096	x	0.13	0.96	x	1.3	0.48	x	0.64	0.24	x	0.32
0.13	x	0.18	1.3	x	1.8	0.66	x	0.88	0.33	x	0.44

**Note:** Hi Res Objectives are not flat-field and therefore limited by field curvature at lower magnifications with both fixed and zoom systems.

# Optical Performance - Fixed Magnification with LWD

## Chart 1D

		<b>2X M Plan Apo</b> 28-21-02-001 WD: 34mm	<b>5X M Plan Apo</b> 28-21-05-001 WD: 41mm	<b>10X M Plan Apo</b> 28-21-10-000 WD: 34mm	<b>20X M Plan Apo</b> 28-21-11-001 WD: 20mm
Max FOV Dia.		17	16	10	5.4
Max Coax FOV Dia.		16	11	5.0	2.6
<b>1.5X Mini</b> Camera Tube  35-08-13-000 EFL: 300mm  <b>NO Stop</b>	NA	0.057	0.14	0.30	0.42
	Res (lp/mm)	170	420	900	1260
	Mag	3.0	7.5	15	30
	DOF (mm)	0.18	0.029	0.0063	0.0032
	FOV (mm) Cam Format	2/3"	2.2 x 2.9	0.88 x 1.2	0.44 x 0.59
	1"	3.2 x 4.3	1.3 x 1.7	0.64 x 0.85	0.32 x 0.43
	4/3"	4.5 x 6.0	1.8 x 2.4	0.90 x 1.2	0.45 x 0.60
	APS-C	5.6 x 8.4	2.2 x 3.3	1.1 x 1.7	0.56 x 0.84
<b>2X Mini</b> Camera Tube  35-08-14-000 EFL: 400mm  <b>NO Stop</b>	NA	0.057	0.14	0.30	0.42
	Res (lp/mm)	170	420	900	1260
	Mag	4.0	10	20	40
	DOF (mm)	0.18	0.029	0.0063	0.0032
	FOV (mm) Cam Format	2/3"	1.7 x 2.2	0.66 x 0.88	0.33 x 0.44
	1"	2.4 x 3.2	0.96 x 1.3	0.48 x 0.64	0.24 x 0.32
	4/3"	3.4 x 4.5	1.4 x 1.8	0.68 x 0.90	0.34 x 0.45
	APS-C	4.2 x 6.3	1.7 x 2.5	0.84 x 1.3	0.42 x 0.63
<b>2.5X Mini</b> Camera Tube  35-08-15-000 EFL: 500mm  <b>NO Stop</b>	NA	0.057	0.14	0.30	0.42
	Res (lp/mm)	170	420	900	1260
	Mag	5.0	12.5	25	50
	DOF (mm)	0.18	0.029	0.0063	0.0032
	FOV (mm) Cam Format	1"	1.9 x 2.6	0.77 x 1.0	0.38 x 0.51
	4/3"	2.7 x 3.6	1.1 x 1.4	0.54 x 0.72	0.27 x 0.36
	APS-C	3.3 x 5.0	1.3 x 2.0	0.67 x 1.0	0.33 x 0.50
	35mm(Full)	4.8 x 7.2	1.9 x 2.9	1.0 x 1.4	0.48 x 0.72
<b>3X Mini</b> Camera Tube  35-08-16-000 EFL: 600mm  <b>NO Stop</b>	NA	0.057	0.14	0.30	0.42
	Res (lp/mm)	170	420	900	1260
	Mag	6.0	15	30	60
	DOF (mm)	0.18	0.029	0.0063	0.0032
	FOV (mm) Cam Format	1"	1.6 x 2.1	0.64 x 0.85	0.32 x 0.43
	4/3"	2.3 x 3.0	0.90 x 1.2	0.45 x 0.60	0.23 x 0.30
	APS-C	2.8 x 4.2	1.1 x 1.7	0.56 x 0.84	0.28 x 0.42
	35mm(Full)	4.0 x 6.0	1.6 x 2.4	0.80 x 1.2	0.40 x 0.60

-- Useable FOV Limited by Coax illumination (>50% Illumination)

-- FOV Limited by vignetting

	Height	x	Width	Diag.
2/3"	6.6	x	8.8	11
1"	9.6	x	12.8	16
4/3"	13.5	x	18	22.5
APS-C*	16.7	x	25.1	30
35mm (Full)	24	x	36	43.3

\*Also known as Half Frame 35mm format

# Objectives - Mini Camera Tubes

<b>50X M Plan Apo</b> 28-21-50-001 WD: 13mm			<b>5X HiRes</b> 28-20-44-000 WD: 34mm			<b>10X HiRes</b> 28-20-45-000 WD: 19mm			<b>20X HiRes</b> 28-20-46-000 WD: 13mm		
2.3			10			5.2			4.5		
1.1			7.0			2.8			2.1		
0.55			0.225			0.45			0.60		
1650			675			1350			1800		
75			7.5			15			30		
0.0019			0.011			0.0028			0.0016		
0.088	x	0.12	0.88	x	1.2	0.44	x	0.59	0.22	x	0.29
0.13	x	0.17	1.3	x	1.7	0.64	x	0.85	0.32	x	0.43
0.18	x	0.24	1.8	x	2.4	0.90	x	1.2	0.45	x	0.60
0.22	x	0.33	2.2	x	3.3	1.1	x	1.7	0.56	x	0.84
0.55			0.225			0.45			0.60		
1650			675			1350			1800		
100			10			20			40		
0.0019			0.011			0.0028			0.0016		
0.066	x	0.088	0.66	x	0.88	0.33	x	0.44	0.17	x	0.22
0.096	x	0.13	0.96	x	1.3	0.48	x	0.64	0.24	x	0.32
0.14	x	0.18	1.4	x	1.8	0.68	x	0.90	0.34	x	0.45
0.17	x	0.25	1.7	x	2.5	0.84	x	1.3	0.42	x	0.63
0.55			0.225			0.45			0.60		
1650			675			1350			1800		
125			12.5			25			50		
0.0019			0.011			0.0028			0.0016		
0.08	x	0.10	0.77	x	1.0	0.38	x	0.51	0.19	x	0.26
0.11	x	0.14	1.1	x	1.4	0.54	x	0.72	0.27	x	0.36
0.13	x	0.20	1.3	x	2.0	0.67	x	1.0	0.33	x	0.50
0.19	x	0.29	1.9	x	2.9	0.96	x	1.4	0.48	x	0.72
0.55			0.225			0.45			0.60		
1650			675			1350			1800		
150			15			30			60		
0.0019			0.011			0.0028			0.0016		
0.064	x	0.085	0.64	x	0.85	0.32	x	0.43	0.16	x	0.21
0.090	x	0.12	0.90	x	1.2	0.45	x	0.60	0.23	x	0.30
0.11	x	0.17	1.1	x	1.7	0.56	x	0.84	0.28	x	0.42
0.16	x	0.24	1.6	x	2.4	0.80	x	1.2	0.40	x	0.60

**Note:** Hi Res Objectives are not flat-field and therefore limited by field curvature at lower magnifications with both fixed and zoom systems.

# Optical Performance - OPTEM 7:1 Zoom with Lower

## Chart 2A

		<b>0.4X Lower Lens</b> 35-00-11-000 WD: 490mm EFL: 500mm		<b>0.5X Lower Lens</b> 35-00-10-000 WD: 390mm EFL: 400mm		<b>0.67X Lower Lens</b> 35-00-09-000 WD: 290mm EFL: 300mm		<b>1X Lower Lens</b> 35-00-08-000 WD: 190mm EFL: 200mm		
<b>Max FOV Dia.</b>		156		125		94		63		
<b>Max Coax FOV Dia.</b>		NR		NR		NR		19		
		Low Mag	High Mag	Low Mag	High Mag	Low Mag	High Mag	Low Mag	High Mag	
<b>0.4X Camera Tube</b>	<b>NA</b>	0.0047	0.016	0.0059	0.019	0.0079	0.026	0.012	0.039	
	<b>Res (lp/mm)</b>	14	47	18	58	24	78	35	116	
	<b>Mag</b>	0.067	0.46	0.084	0.58	0.11	0.77	0.17	1.2	
	<b>DOF (mm)</b>	25	2.4	16	1.5	9.2	0.85	4.1	0.38	
35-08-00-000 EFL: 80mm	<b>FOV (mm) Cam Format</b>	<b>1/3"</b>	54 x 71	7.8 x 10	43 x 57	6.2 x 8.3	32 x 43	4.7 x 6.2	21 x 29	3.1 x 4.1
		<b>1/2"</b>	71 x 95	10 x 14	57 x 76	8.3 x 11	43 x 57	6.2 x 8.3	29 x 38	4.1 x 5.5
		<b>2/3"</b>	98 x 131	14 x 19	79 x 105	11 x 15	59 x 79	8.5 x 11	39 x 52	5.7 x 7.6
<b>0.5X Camera Tube</b>	<b>NA</b>	0.0047	0.016	0.0059	0.019	0.0079	0.026	0.012	0.039	
	<b>Res (lp/mm)</b>	14	47	18	58	24	78	35	116	
	<b>Mag</b>	0.084	0.58	0.11	0.73	0.14	0.97	0.21	1.5	
	<b>DOF (mm)</b>	25	2.4	16	1.5	9.2	0.85	4.1	0.38	
35-08-01-000 EFL: 100mm	<b>FOV (mm) Cam Format</b>	<b>1/3"</b>	43 x 57	6.2 x 8.3	34 x 46	5.0 x 6.6	26 x 34	3.7 x 5.0	17 x 23	2.5 x 3.3
		<b>1/2"</b>	57 x 76	8.3 x 11	46 x 61	6.6 x 8.8	34 x 46	5.0 x 6.6	23 x 30	3.3 x 4.4
		<b>2/3"</b>	79 x 105	11 x 15	63 x 84	9.1 x 12	47 x 63	6.8 x 9.1	31 x 42	4.6 x 6.1
<b>0.6X Camera Tube</b>	<b>NA</b>	0.0047	0.016	0.0059	0.019	0.0079	0.026	0.012	0.039	
	<b>Res (lp/mm)</b>	14	47	18	58	24	78	35	116	
	<b>Mag</b>	0.10	0.70	0.13	0.87	0.17	1.2	0.25	1.7	
	<b>DOF (mm)</b>	25	2.4	16	1.5	9.2	0.85	4.1	0.38	
35-08-02-000 EFL: 120mm	<b>FOV (mm) Cam Format</b>	<b>1/3"</b>	36 x 48	5.2 x 6.9	29 x 38	4.1 x 5.5	21 x 29	3.1 x 4.1	14 x 19	2.1 x 2.8
		<b>1/2"</b>	48 x 63	6.9 x 9.2	38 x 51	5.5 x 7.4	29 x 38	4.1 x 5.5	19 x 25	2.8 x 3.7
		<b>2/3"</b>	65 x 87	9.5 x 13	52 x 70	7.6 x 10	39 x 52	5.7 x 7.6	26 x 35	3.8 x 5.1
<b>0.8X Camera Tube</b>	<b>NA</b>	0.0047	0.016	0.0059	0.019	0.0079	0.026	0.012	0.039	
	<b>Res (lp/mm)</b>	14	47	18	58	24	78	35	116	
	<b>Mag</b>	0.13	0.93	0.17	1.2	0.22	1.5	0.34	2.3	
	<b>DOF (mm)</b>	25	2.4	16	1.5	9.2	0.85	4.1	0.38	
35-08-04-000 EFL: 160mm	<b>FOV (mm) Cam Format</b>	<b>1/3"</b>	27 x 36	3.9 x 5.2	21 x 29	3.1 x 4.1	16 x 21	2.3 x 3.1	11 x 14	1.6 x 2.1
		<b>1/2"</b>	36 x 48	5.2 x 6.9	29 x 38	4.1 x 5.5	21 x 29	3.1 x 4.1	14 x 19	2.1 x 2.8
		<b>2/3"</b>	49 x 65	7.1 x 9.5	39 x 52	5.7 x 7.6	29 x 39	4.3 x 5.7	20 x 26	2.8 x 3.8
<b>1X Camera Tube</b>	<b>NA</b>	0.0047	0.016	0.0059	0.019	0.0079	0.026	0.012	0.039	
	<b>Res (lp/mm)</b>	14	47	18	58	24	78	35	116	
	<b>Mag</b>	0.17	1.2	0.21	1.5	0.28	1.9	0.42	2.9	
	<b>DOF (mm)</b>	25	2.4	16	1.5	9.2	0.85	4.1	0.38	
35-08-06-000 EFL: 200mm	<b>FOV (mm) Cam Format</b>	<b>1/3"</b>	21 x 29	3.1 x 4.1	17 x 23	2.5 x 3.3	13 x 17	1.9 x 2.5	8.6 x 11	1.2 x 1.7
		<b>1/2"</b>	29 x 38	4.1 x 5.5	23 x 30	3.3 x 4.4	17 x 23	2.5 x 3.3	11 x 15	1.7 x 2.2
		<b>2/3"</b>	39 x 52	5.7 x 7.6	31 x 42	4.6 x 6.1	24 x 31	3.4 x 4.6	16 x 21	2.3 x 3.0

 -- Useable FOV Limited by Coax illumination (>50% Illumination)

 -- FOV Limited by vignetting

**NR** = Not recommended for Coax illumination

# Lens

<b>1.25X Lower Lens</b> 35-00-06-000 WD: 155mm EFL: 160mm		<b>1.43X Lower Lens</b> 35-00-05-000 WD: 135mm EFL: 140mm		<b>1.67 Lower Lens</b> 35-00-04-000 WD: 110mm EFL: 120mm		<b>2X Lower Lens</b> 35-00-03-000 WD: 95mm EFL: 100mm		<b>3X Lower Lens</b> 35-00-01-000 WD: 50mm EFL: 67mm		<b>4X Lower Lens</b> 35-00-02-000 WD: 32mm EFL: 50mm	
50		44		38		31		21		16	
19		19		18		19		13		9.4	
Low Mag	High Mag	Low Mag	High Mag	Low Mag	High Mag	Low Mag	High Mag	Low Mag	High Mag	Low Mag	High Mag
0.015	0.048	0.017	0.055	0.020	0.065	0.024	0.078	0.035	0.12	0.047	0.16
44	145	51	166	59	194	71	233	106	349	142	465
0.21	1.5	0.24	1.7	0.28	1.9	0.34	2.3	0.50	3.5	0.67	4.6
2.6	0.24	2.0	0.19	1.5	0.14	1.0	0.094	0.45	0.042	0.25	0.024
17 x 23	2.5 x 3.3	15 x 20	2.2 x 2.9	13 x 17	1.9 x 2.5	11 x 14	1.6 x 2.1	7.1 x 9.5	1.0 x 1.4	5.4 x 7.1	0.78 x 1.0
23 x 30	3.3 x 4.4	20 x 27	2.9 x 3.9	17 x 23	2.5 x 3.3	14 x 19	2.1 x 2.8	9.5 x 13	1.4 x 1.8	7.1 x 10	1.0 x 1.4
31 x 42	4.6 x 6.1	28 x 37	4.0 x 5.3	24 x 31	3.4 x 4.6	20 x 26	2.8 x 3.8	13 x 17	1.9 x 2.5	10 x 13	1.4 x 1.9
0.015	0.048	0.017	0.055	0.020	0.065	0.024	0.078	0.035	0.12	0.047	0.16
44	145	51	166	59	194	71	233	106	349	142	465
0.26	1.8	0.30	2.1	0.35	2.4	0.42	2.9	0.63	4.3	0.84	5.8
2.6	0.24	2.0	0.19	1.5	0.14	1.0	0.094	0.45	0.042	0.25	0.024
14 x 18	2.0 x 2.6	12 x 16	1.7 x 2.3	10 x 14	1.5 x 2.0	8.6 x 11	1.24 x 1.7	5.7 x 7.6	0.83 x 1.1	4.3 x 5.7	0.62 x 0.83
18 x 24	2.6 x 3.5	16 x 21	2.3 x 3.1	14 x 18	2.0 x 2.6	11 x 15	1.7 x 2.2	7.6 x 10	1.1 x 1.5	5.7 x 7.6	0.83 x 1.1
25 x 34	3.6 x 4.9	22 x 29	3.2 x 4.2	19 x 25	2.7 x 3.6	16 x 21	2.3 x 3.0	10 x 14	1.5 x 2.0	7.9 x 10	1.1 x 1.5
0.015	0.048	0.017	0.055	0.020	0.065	0.024	0.078	0.035	0.12	0.047	0.16
44	145	51	166	59	194	71	233	106	349	142	465
0.32	2.2	0.36	2.5	0.42	2.9	0.50	3.5	0.76	5.2	1.0	7.0
2.6	0.24	2.0	0.19	1.5	0.14	1.0	0.094	0.45	0.042	0.25	0.024
11 x 15	1.7 x 2.2	10 x 13	1.4 x 1.9	8.6 x 11	1.2 x 1.7	7.1 x 9.5	1.0 x 1.4	4.8 x 6.4	0.69 x 0.92	3.6 x 4.8	0.52 x 0.69
15 x 20	2.2 x 2.9	13 x 18	1.9 x 2.6	11 x 15	1.7 x 2.2	9.5 x 13	1.4 x 1.8	6.4 x 8.5	0.92 x 1.2	4.8 x 6.3	0.69 x 0.92
21 x 28	3.0 x 4.0	18 x 24	2.7 x 3.5	16 x 21	2.3 x 3.0	13 x 17	1.9 x 2.5	8.7 x 12	1.3 x 1.7	6.5 x 8.7	0.95 x 1.3
0.015	0.048	0.017	0.055	0.020	0.065	0.024	0.078	0.035	0.12	0.047	0.16
44	145	51	166	59	194	71	233	106	349	142	465
0.42	2.9	0.48	3.3	0.56	3.9	0.67	4.6	1.0	7.0	1.3	9.3
2.6	0.24	2.0	0.19	1.5	0.14	1.0	0.094	0.45	0.042	0.25	0.024
8.6 x 11	1.2 x 1.7	7.5 x 10	1.1 x 1.4	6.4 x 8.6	0.93 x 1.2	5.4 x 7.1	0.78 x 1.0	3.6 x 4.8	0.52 x 0.69	2.7 x 3.6	0.39 x 0.52
11 x 15	1.7 x 2.2	10 x 13	1.4 x 1.9	8.6 x 11	1.2 x 1.7	7.1 x 9.5	1.0 x 1.4	4.8 x 6.4	0.69 x 0.92	3.6 x 4.8	0.52 x 0.69
16 x 21	2.3 x 3.0	14 x 18	2.0 x 2.7	12 x 16	1.7 x 2.3	9.8 x 13	1.4 x 1.9	6.6 x 8.7	0.95 x 1.3	4.9 x 6.5	0.71 x 0.95
0.015	0.048	0.017	0.055	0.020	0.065	0.024	0.078	0.035	0.12	0.047	0.16
44	145	51	166	59	194	71	233	106	349	142	465
0.53	3.6	0.60	4.1	0.70	4.8	0.84	5.8	1.3	8.7	1.7	12
2.6	0.24	2.0	0.19	1.5	0.14	1.0	0.094	0.45	0.042	0.25	0.024
6.9 x 9.1	0.99 x 1.3	6.0 x 8.0	0.87 x 1.2	5.1 x 6.9	0.74 x 0.99	4.3 x 5.7	0.62 x 0.83	2.9 x 3.8	0.41 x 0.55	2.1 x 2.9	0.31 x 0.41
9.1 x 12	1.3 x 1.8	8.0 x 11	1.2 x 1.5	6.9 x 9.1	0.99 x 1.3	5.7 x 7.6	0.83 x 1.1	3.8 x 5.1	0.55 x 0.74	2.9 x 3.8	0.41 x 0.55
13 x 17	1.8 x 2.4	11 x 15	1.6 x 2.1	9.4 x 13	1.4 x 1.8	7.9 x 10	1.1 x 1.5	5.2 x 7.0	0.76 x 1.0	3.9 x 5.2	0.57 x 0.76

# Optical Performance - OPTEM 7:1 Zoom with Lower

## Chart 2B

		<b>0.4X Lower Lens</b> 35-00-11-000 WD: 490mm EFL: 500mm		<b>0.5X Lower Lens</b> 35-00-10-000 WD: 390mm EFL: 400mm		<b>0.67X Lower Lens</b> 35-00-09-000 WD: 290mm EFL: 300mm		<b>1X Lower Lens</b> 35-00-08-000 WD: 190mm EFL: 200mm			
Max FOV Dia.		156		125		94		63			
Max Coax FOV Dia.		NR		NR		NR		19			
		Low Mag	High Mag	Low Mag	High Mag	Low Mag	High Mag	Low Mag	High Mag		
<b>1.5X Mini Camera Tube</b>  35-08-13-000 EFL: 300mm	FOV (mm)	NA	0.0047	0.016	0.0059	0.019	0.0079	0.026	0.012	0.039	
		Res (lp/mm)	14	47	18	58	24	78	35	116	
		Mag	0.25	1.7	0.32	2.2	0.42	2.9	0.63	4.4	
		DOF (mm)	25	2.4	16	1.5	9.2	0.85	4.1	0.38	
	Cam Format	2/3"	26 x 35	3.8 x 5.1	21 x 28	3.0 x 4.0	16 x 21	2.3 x 3.0	10 x 14	1.5 x 2.0	
		1"	38 x 51	5.5 x 7.4	30 x 41	4.4 x 5.9	23 x 30	3.3 x 4.4	15 x 20	2.2 x 2.9	
		4/3"	54 x 71	7.8 x 10	43 x 57	6.2 x 8.3	32 x 43	4.7 x 6.2	21 x 29	3.1 x 4.1	
		APS-C	66 x 100	10 x 14	53 x 80	7.7 x 12	40 x 60	5.8 x 8.7	27 x 40	3.8 x 5.8	
	<b>2X Mini Camera Tube</b>  35-08-14-000 EFL: 400mm	FOV (mm)	NA	0.0047	0.016	0.0059	0.019	0.0079	0.026	0.012	0.039
			Res (lp/mm)	14	47	18	58	24	78	35	116
Mag			0.34	2.3	0.42	2.9	0.56	3.9	0.84	5.8	
DOF (mm)			25	2.4	16	1.5	9.2	0.85	4.1	0.38	
Cam Format		2/3"	20 x 26	2.8 x 3.8	16 x 21	2.3 x 3.0	12 x 16	1.7 x 2.3	7.9 x 10	1.1 x 1.5	
		1"	29 x 38	4.1 x 5.5	23 x 30	3.3 x 4.4	17 x 23	2.5 x 3.3	11 x 15	1.7 x 2.2	
		4/3"	40 x 54	5.8 x 7.8	32 x 43	4.7 x 6.2	24 x 32	3.5 x 4.7	16 x 21	2.3 x 3.1	
		APS-C	50 x 75	7.2 x 11	40 x 60	5.8 x 8.7	30 x 45	4.3 x 6.5	20 x 30	2.9 x 4.3	
<b>2.5X Mini Camera Tube</b>  35-08-15-000 EFL: 500mm		FOV (mm)	NA	0.0047	0.016	0.0059	0.019	0.0079	0.026	0.012	0.039
			Res (lp/mm)	14	47	18	58	24	78	35	116
	Mag		0.42	2.9	0.53	3.6	0.70	4.8	1.1	7.3	
	DOF (mm)		25	2.4	16	1.5	9.2	0.85	4.1	0.38	
	Cam Format	1"	23 x 30	3.3 x 4.4	18 x 24	2.6 x 3.5	14 x 18	2.0 x 2.6	9.1 x 12	1.3 x 1.8	
		4/3"	32 x 43	4.7 x 6.2	26 x 34	3.7 x 5.0	19 x 26	2.8 x 3.7	13 x 17	1.9 x 2.5	
		APS-C	40 x 60	5.8 x 8.7	32 x 48	4.6 x 6.9	24 x 36	3.5 x 5.2	16 x 24	2.3 x 3.5	
		35mm(Full)	57 x 86	8.3 x 12	46 x 69	6.6 x 9.9	34 x 51	5.0 x 7.4	23 x 34	3.3 x 5.0	
	<b>3X Mini Camera Tube</b>  35-08-16-000 EFL: 600mm	FOV (mm)	NA	0.0047	0.016	0.0059	0.019	0.0079	0.026	0.012	0.039
			Res (lp/mm)	14	47	18	58	24	78	35	116
Mag			0.50	3.5	0.63	4.4	0.84	5.8	1.3	8.7	
DOF (mm)			25	2.4	16	1.5	9.2	0.85	4.1	0.38	
Cam Format		1"	19 x 25	2.8 x 3.7	15 x 20	2.2 x 2.9	11 x 15	1.7 x 2.2	7.6 x 10	1.1 x 1.5	
		4/3"	27 x 36	3.9 x 5.2	21 x 29	3.1 x 4.1	16 x 21	2.3 x 3.1	11 x 14	1.6 x 2.1	
		APS-C	33 x 50	4.8 x 7.2	27 x 40	3.8 x 5.8	20 x 30	2.9 x 4.3	13 x 20	1.9 x 2.9	
		35mm(Full)	48 x 71	6.9 x 10	38 x 57	5.5 x 8.3	29 x 43	4.1 x 6.2	19 x 29	2.8 x 4.1	

-- Useable FOV Limited by Coax illumination (>50% Illumination)

-- FOV Limited by vignetting

**NR** = Not recommended for Coax illumination

	Height	x	Width	Diag.
2/3"	6.6	x	8.8	11
1"	9.6	x	12.8	16
4/3"	13.5	x	18	22.5
APS-C*	16.7	x	25.1	30
35mm (Full)	24	x	36	43.3

\*Also known as Half Frame 35mm format



# Lens - Mini Camera Tubes

<b>1.25X Lower Lens</b> 35-00-06-000 WD: 155mm EFL: 160mm		<b>1.43X Lower Lens</b> 35-00-05-000 WD: 135mm EFL: 140mm		<b>1.67 Lower Lens</b> 35-00-04-000 WD: 110mm EFL: 120mm		<b>2X Lower Lens</b> 35-00-03-000 WD: 95mm EFL: 100mm		<b>3X Lower Lens</b> 35-00-01-000 WD: 50mm EFL: 67mm		<b>4X Lower Lens</b> 35-00-02-000 WD: 32mm EFL: 50mm	
50		44		38		31		21		16	
19		19		18		19		13		9.4	
Low Mag	High Mag	Low Mag	High Mag	Low Mag	High Mag	Low Mag	High Mag	Low Mag	High Mag	Low Mag	High Mag
0.015	0.048	0.017	0.055	0.020	0.065	0.024	0.078	0.035	0.12	0.047	0.16
44	145	51	166	59	194	71	233	106	349	142	465
0.79	5.4	0.90	6.2	1.1	7.3	1.3	8.7	1.9	13	2.5	17
2.6	0.24	2.0	0.19	1.5	0.14	1.0	0.094	0.45	0.042	0.25	0.024
8.4 x 11	1.2 x 1.6	7.3 x 10	1.1 x 1.4	6.3 x 8.4	0.91 x 1.2	5.2 x 7.0	0.76 x 1.0	3.5 x 4.7	0.51 x 0.67	2.6 x 3.5	0.38 x 0.51
12 x 16	1.8 x 2.4	11 x 14	1.5 x 2.1	9.1 x 12	1.3 x 1.8	7.6 x 10	1.1 x 1.5	5.1 x 6.8	0.74 x 0.98	3.8 x 5.1	0.55 x 0.74
17 x 23	2.5 x 3.3	15 x 20	2.2 x 2.9	13 x 17	1.9 x 2.5	11 x 14	1.6 x 2.1	7.1 x 9.5	1.0 x 1.4	5.4 x 7.1	0.78 x 1.0
21 x 32	3.1 x 4.6	19 x 28	2.7 x 4.0	16 x 24	2.3 x 3.5	13 x 20	1.9 x 2.9	8.8 x 13	1.3 x 1.9	6.6 x 10	0.96 x 1.4
0.015	0.048	0.017	0.055	0.020	0.065	0.024	0.078	0.035	0.12	0.047	0.16
44	145	51	166	59	194	71	233	106	349	142	465
1.1	7.3	1.2	8.3	1.4	9.7	1.7	12	2.5	17	3.4	23
2.6	0.24	2.0	0.19	1.5	0.14	1.0	0.094	0.45	0.042	0.25	0.024
6.3 x 8.4	0.91 x 1.2	5.5 x 7.3	0.80 x 1.1	4.7 x 6.3	0.68 x 0.91	3.9 x 5.2	0.57 x 0.76	2.6 x 3.5	0.38 x 0.51	2.0 x 2.6	0.28 x 0.38
9.1 x 12	1.3 x 1.8	8.0 x 11	1.2 x 1.5	6.9 x 9.1	0.99 x 1.3	5.7 x 7.6	0.83 x 1.1	3.8 x 5.1	0.55 x 0.74	2.9 x 3.8	0.41 x 0.55
13 x 17	1.9 x 2.5	11 x 15	1.6 x 2.2	9.6 x 13	1.4 x 1.9	8.0 x 11	1.2 x 1.6	5.4 x 7.1	0.78 x 1.0	4.0 x 5.4	0.58 x 0.78
16 x 24	2.3 x 3.5	14 x 21	2.0 x 3.0	12 x 18	1.7 x 2.6	9.9 x 15	1.4 x 2.2	6.6 x 10	0.96 x 1.4	5.0 x 7.5	0.72 x 1.1
0.015	0.048	0.017	0.055	0.020	0.065	0.024	0.078	0.035	0.12	0.047	0.16
44	145	51	166	59	194	71	233	106	349	142	465
1.3	9.1	1.5	10	1.8	12	2.1	15	3.1	22	4.2	29
2.6	0.24	2.0	0.19	1.5	0.14	1.0	0.094	0.45	0.042	0.25	0.024
7.3 x 9.8	1.1 x 1.4	6.4 x 8.5	0.93 x 1.2	5.5 x 7.3	0.79 x 1.1	4.6 x 6.1	0.66 x 0.88	3.0 x 4.1	0.44 x 0.59	2.3 x 3.0	0.33 x 0.44
10 x 14	1.5 x 2.0	9.0 x 12	1.3 x 1.7	7.7 x 10	1.1 x 1.5	6.4 x 8.6	0.93 x 1.2	4.3 x 5.7	0.62 x 0.83	3.2 x 4.3	0.47 x 0.62
13 x 19	1.8 x 2.8	11 x 17	1.6 x 2.4	9.5 x 14	1.4 x 2.1	8.0 x 12	1.2 x 1.7	5.3 x 8.0	0.77 x 1.2	4.0 x 6.0	0.58 x 0.87
18 x 27	2.6 x 4.0	16 x 24	2.3 x 3.5	14 x 21	2.0 x 3.0	11 x 17	1.7 x 2.5	7.6 x 11	1.1 x 1.7	5.7 x 8.6	0.83 x 1.2
0.015	0.048	0.017	0.055	0.020	0.065	0.024	0.078	0.035	0.12	0.047	0.16
44	145	51	166	59	194	71	233	106	349	142	465
1.6	11	1.8	12	2.1	15	2.5	17	3.8	26	5.0	35
2.6	0.24	2.0	0.19	1.5	0.14	1.0	0.094	0.45	0.042	0.25	0.024
6.1 x 8.1	0.88 x 1.2	5.3 x 7.1	0.77 x 1.0	4.6 x 6.1	0.66 x 0.88	3.8 x 5.1	0.55 x 0.74	2.5 x 3.4	0.37 x 0.49	1.9 x 2.5	0.28 x 0.37
8.6 x 11	1.2 x 1.7	7.5 x 10	1.1 x 1.4	6.4 x 8.6	0.93 x 1.2	5.4 x 7.1	0.78 x 1.0	3.6 x 4.8	0.52 x 0.69	2.7 x 3.6	0.39 x 0.52
11 x 16	1.5 x 2.3	9.3 x 14	1.3 x 2.0	8.0 x 12	1.2 x 1.7	6.6 x 10	0.96 x 1.4	4.4 x 6.6	0.64 x 0.96	3.3 x 5.0	0.48 x 0.72
15 x 23	2.2 x 3.3	13 x 20	1.9 x 2.9	11 x 17	1.7 x 2.5	9.5 x 14	1.4 x 2.1	6.4 x 9.5	0.92 x 1.4	4.8 x 7.1	0.69 x 1.0

# Optical Performance - OPTEM 7:1 Zoom with LWD

## Chart 2C

		<b>2X M Plan Apo</b> 28-21-02-001 WD: 34mm		<b>5X M Plan Apo</b> 28-21-05-001 WD: 41mm		<b>10X M Plan Apo</b> 28-21-10-000 WD: 34mm			
		Max FOV Dia.		6.9		3.2			
		Max Coax FOV Dia.		6.5		2.2			
		Low Mag	High Mag	Low Mag	High Mag	Low Mag	High Mag		
<b>0.4X</b> Camera Tube  35-08-00-000 EFL: 80mm	<b>NA</b> <b>Res (lp/mm)</b> <b>Mag</b> <b>DOF (mm)</b>	0.024	0.057	0.059	0.14	0.12	0.30		
		71	170	177	420	354	900		
		0.34	2.3	0.84	5.8	1.7	12		
		1.0	0.18	0.16	0.029	0.041	0.0063		
	<b>FOV (mm)</b> <b>Cam Format</b>	<b>1/3"</b>	11 x 14	1.6 x 2.1	4.3 x 5.7	0.62 x 0.83	2.1 x 2.9	0.31 x 0.41	
		<b>1/2"</b>	14 x 19	2.1 x 2.8	5.7 x 7.6	0.83 x 1.1	2.9 x 3.8	0.41 x 0.55	
		<b>2/3"</b>	20 x 26	2.8 x 3.8	7.9 x 10	1.1 x 1.5	3.9 x 5.2	0.57 x 0.76	
		<b>0.5X</b> Camera Tube  35-08-01-000 EFL: 100mm	<b>NA</b> <b>Res (lp/mm)</b> <b>Mag</b> <b>DOF (mm)</b>	0.024	0.057	0.059	0.14	0.12	0.30
				71	170	177	420	354	900
				0.42	2.9	1.1	7.3	2.1	15
1.0	0.18			0.16	0.029	0.041	0.0063		
<b>FOV (mm)</b> <b>Cam Format</b>	<b>1/3"</b>		8.6 x 11	1.2 x 1.7	3.4 x 4.6	0.50 x 0.66	1.7 x 2.3	0.25 x 0.33	
	<b>1/2"</b>		11 x 15	1.7 x 2.2	4.6 x 6.1	0.66 x 0.88	2.3 x 3.0	0.33 x 0.44	
	<b>2/3"</b>		16 x 21	2.3 x 3.0	6.3 x 8.4	0.91 x 1.2	3.1 x 4.2	0.46 x 0.61	
	<b>0.6X</b> Camera Tube  35-08-02-000 EFL: 120mm		<b>NA</b> <b>Res (lp/mm)</b> <b>Mag</b> <b>DOF (mm)</b>	0.024	0.057	0.059	0.14	0.12	0.30
				71	170	177	420	354	900
				0.50	3.5	1.3	8.7	2.5	17
1.0		0.18		0.16	0.029	0.041	0.0063		
<b>FOV (mm)</b> <b>Cam Format</b>		<b>1/3"</b>	7.1 x 9.5	1.0 x 1.4	2.9 x 3.8	0.41 x 0.55	1.4 x 1.9	0.21 x 0.28	
		<b>1/2"</b>	9.5 x 13	1.4 x 1.8	3.8 x 5.1	0.55 x 0.74	1.9 x 2.5	0.28 x 0.37	
		<b>2/3"</b>	13 x 17	1.9 x 2.5	5.2 x 7.0	0.76 x 1.0	2.6 x 3.5	0.38 x 0.51	
		<b>0.8X</b> Camera Tube  35-08-04-000 EFL: 160mm	<b>NA</b> <b>Res (lp/mm)</b> <b>Mag</b> <b>DOF (mm)</b>	0.024	0.057	0.059	0.14	0.12	0.30
				71	170	177	420	354	900
				0.67	4.6	1.7	12	3.4	23
1.0	0.18			0.16	0.029	0.041	0.0063		
<b>FOV (mm)</b> <b>Cam Format</b>	<b>1/3"</b>		5.4 x 7.1	0.78 x 1.0	2.1 x 2.9	0.31 x 0.41	1.1 x 1.4	0.16 x 0.21	
	<b>1/2"</b>		7.1 x 9.5	1.0 x 1.4	2.9 x 3.8	0.41 x 0.55	1.4 x 1.9	0.21 x 0.28	
	<b>2/3"</b>		9.8 x 13	1.4 x 1.9	3.9 x 5.2	0.57 x 0.76	2.0 x 2.6	0.28 x 0.38	
	<b>1X</b> Camera Tube  35-08-06-000 EFL: 200mm		<b>NA</b> <b>Res (lp/mm)</b> <b>Mag</b> <b>DOF (mm)</b>	0.024	0.057	0.059	0.14	0.12	0.30
				71	170	177	420	354	900
				0.84	5.8	2.1	15	4.2	29
1.0		0.18		0.16	0.029	0.041	0.0063		
<b>FOV (mm)</b> <b>Cam Format</b>		<b>1/3"</b>	4.3 x 5.7	0.62 x 0.83	1.7 x 2.3	0.25 x 0.33	0.86 x 1.1	0.12 x 0.17	
		<b>1/2"</b>	5.7 x 7.6	0.83 x 1.1	2.3 x 3.0	0.33 x 0.44	1.1 x 1.5	0.17 x 0.22	
		<b>2/3"</b>	7.9 x 10	1.1 x 1.5	3.1 x 4.2	0.46 x 0.61	1.6 x 2.1	0.23 x 0.30	

Light yellow background: -- Useable FOV Limited by Coax illumination (>50% Illumination)

Yellow background: -- FOV Limited by vignetting

50X M Plan Apo is NOT recommended for use with a 7:1 Zoom  
0.4X and 0.5X Camera Tubes are not recommended for use with  
a 7:1 Zoom and Microscope Objectives.

# Objectives

<b>20X M Plan Apo</b> 28-21-11-001 WD: 20mm		<b>5X HiRes</b> 28-20-44-000 WD: 34mm		<b>10X HiRes</b> 28-20-45-000 WD: 19mm		<b>20X HiRes</b> 28-20-46-000 WD: 13mm	
1.2		6.4		3.1		1.7	
0.83		4.9		2.2		1.1	
Low Mag	High Mag	Low Mag	High Mag	Low Mag	High Mag	Low Mag	High Mag
0.24	0.42	0.059	0.19	0.12	0.39	0.24	0.60
708	1260	177	581	354	1163	708	1800
3.4	23	0.84	5.8	1.7	12	3.4	23
0.010	0.0032	0.16	0.015	0.041	0.0038	0.010	0.00158
1.1 x 1.4	0.16 x 0.21	4.3 x 5.7	0.62 x 0.83	2.1 x 2.9	0.31 x 0.41	1.1 x 1.4	0.16 x 0.21
1.4 x 1.9	0.21 x 0.28	5.7 x 7.6	0.83 x 1.1	2.9 x 3.8	0.41 x 0.55	1.4 x 1.9	0.21 x 0.28
2.0 x 2.6	0.28 x 0.38	7.9 x 10	1.1 x 1.5	3.9 x 5.2	0.57 x 0.76	2.0 x 2.6	0.28 x 0.38
0.24	0.42	0.059	0.19	0.12	0.39	0.24	0.60
708	1260	177	581	354	1163	708	1800
4.2	29	1.1	7.3	2.1	15	4.2	29
0.010	0.0032	0.16	0.015	0.041	0.0038	0.010	0.00158
0.86 x 1.1	0.12 x 0.17	3.4 x 4.6	0.50 x 0.66	1.7 x 2.3	0.25 x 0.33	0.9 x 1.1	0.12 x 0.17
1.1 x 1.5	0.17 x 0.22	4.6 x 6.1	0.66 x 0.88	2.3 x 3.0	0.33 x 0.44	1.1 x 1.5	0.17 x 0.22
1.6 x 2.1	0.23 x 0.30	6.3 x 8.4	0.91 x 1.2	3.1 x 4.2	0.46 x 0.61	1.6 x 2.1	0.23 x 0.30
0.24	0.42	0.059	0.19	0.12	0.39	0.24	0.60
708	1260	177	581	354	1163	708	1800
5.0	35	1.3	8.7	2.5	17	5.0	35
0.010	0.0032	0.16	0.015	0.041	0.0038	0.010	0.00158
0.71 x 0.95	0.10 x 0.14	2.9 x 3.8	0.41 x 0.55	1.4 x 1.9	0.21 x 0.28	0.71 x 0.95	0.10 x 0.14
0.95 x 1.3	0.14 x 0.18	3.8 x 5.1	0.55 x 0.74	1.9 x 2.5	0.28 x 0.37	0.95 x 1.3	0.14 x 0.18
1.3 x 1.7	0.19 x 0.25	5.2 x 7.0	0.76 x 1.0	2.6 x 3.5	0.38 x 0.51	1.3 x 1.7	0.19 x 0.25
0.24	0.42	0.059	0.19	0.12	0.39	0.24	0.60
708	1260	177	581	354	1163	708	1800
6.7	46	1.7	12	3.4	23	6.7	46
0.010	0.0032	0.16	0.015	0.041	0.0038	0.010	0.00158
0.54 x 0.71	0.078 x 0.10	2.1 x 2.9	0.31 x 0.41	1.1 x 1.4	0.16 x 0.21	0.54 x 0.71	0.078 x 0.10
0.71 x 0.95	0.10 x 0.14	2.9 x 3.8	0.41 x 0.55	1.4 x 1.9	0.21 x 0.28	0.71 x 0.95	0.10 x 0.14
0.98 x 1.3	0.14 x 0.19	3.9 x 5.2	0.57 x 0.76	2.0 x 2.6	0.28 x 0.38	0.98 x 1.3	0.14 x 0.19
0.24	0.42	0.059	0.19	0.12	0.39	0.24	0.60
708	1260	177	581	354	1163	708	1800
8.4	58	2.1	15	4.2	29	8.4	58
0.010	0.0032	0.16	0.015	0.041	0.0038	0.010	0.00158
0.43 x 0.57	0.062 x 0.083	1.7 x 2.3	0.25 x 0.33	0.86 x 1.1	0.12 x 0.17	0.43 x 0.57	0.062 x 0.083
0.57 x 0.76	0.083 x 0.11	2.3 x 3.0	0.33 x 0.44	1.1 x 1.5	0.17 x 0.22	0.57 x 0.76	0.083 x 0.11
0.79 x 1.0	0.11 x 0.15	3.1 x 4.2	0.46 x 0.61	1.6 x 2.1	0.23 x 0.30	0.79 x 1.0	0.11 x 0.15

**Note:** Hi Res Objectives are not flat-field and therefore limited by field curvature at lower magnifications with both fixed and zoom systems.

# Optical Performance - OPTEM 7:1 Zoom with LWD

## Chart 2D

		<b>2X M Plan Apo</b> 28-21-02-001 WD: 34mm		<b>5X M Plan Apo</b> 28-21-05-001 WD: 41mm		<b>10X M Plan Apo</b> 28-21-10-000 WD: 34mm		
Max FOV Dia.		14		6.9		3.2		
Max Coax FOV Dia.		11		6.5		2.2		
		Low Mag	High Mag	Low Mag	High Mag	Low Mag	High Mag	
<b>1.5X Mini</b> Camera Tube  35-08-13-000 EFL: 300mm	FOV (mm)	NA	0.024	0.057	0.059	0.14	0.12	0.30
		Res (lp/mm)	71	170	177	420	354	900
		Mag	1.3	8.7	3.2	22	6.30	44
		DOF (mm)	1.0	0.18	0.16	0.029	0.041	0.0063
	Cam Format	2/3"	5.2 x 7.0	0.76 x 1.0	2.1 x 2.8	0.30 x 0.40	1.0 x 1.4	0.15 x 0.20
		1"	7.6 x 10	1.1 x 1.5	3.0 x 4.1	0.44 x 0.59	1.5 x 2.0	0.22 x 0.29
		4/3"	11 x 14	1.6 x 2.1	4.3 x 5.7	0.62 x 0.83	2.1 x 2.9	0.31 x 0.41
		APS-C	13 x 20	1.9 x 2.9	5.3 x 8.0	0.77 x 1.2	2.7 x 4.0	0.38 x 0.58
<b>2X Mini</b> Camera Tube  35-08-14-000 EFL: 400mm	FOV (mm)	NA	0.024	0.057	0.059	0.14	0.12	0.30
		Res (lp/mm)	71	170	177	420	354	900
		Mag	1.7	12	4.2	29	8.4	58
		DOF (mm)	1.0	0.18	0.16	0.029	0.041	0.0063
	Cam Format	2/3"	3.9 x 5.2	0.57 x 0.76	1.6 x 2.1	0.23 x 0.30	0.79 x 1.0	0.11 x 0.15
		1"	5.7 x 7.6	0.83 x 1.1	2.3 x 3.0	0.33 x 0.44	1.1 x 1.5	0.17 x 0.22
		4/3"	8.0 x 11	1.2 x 1.6	3.2 x 4.3	0.47 x 0.62	1.6 x 2.1	0.23 x 0.31
		APS-C	10 x 15	1.4 x 2.2	4.0 x 6.0	0.58 x 0.87	2.0 x 3.0	0.29 x 0.43
<b>2.5X Mini</b> Camera Tube  35-08-15-000 EFL: 500mm	FOV (mm)	NA	0.024	0.057	0.059	0.14	0.12	0.30
		Res (lp/mm)	71	170	177	420	354	900
		Mag	2.1	15	5.3	36	11	73
		DOF (mm)	1.0	0.18	0.16	0.029	0.041	0.0063
	Cam Format	1"	4.6 x 6.1	0.66 x 0.88	1.8 x 2.4	0.26 x 0.35	0.91 x 1.2	0.13 x 0.18
		4/3"	6.4 x 8.6	0.93 x 1.2	2.6 x 3.4	0.37 x 0.50	1.3 x 1.7	0.19 x 0.25
		APS-C	8.0 x 12	1.2 x 1.7	3.2 x 4.8	0.46 x 0.69	1.6 x 2.4	0.23 x 0.35
		35mm(Full)	11 x 17	1.7 x 2.5	4.6 x 6.9	0.66 x 0.99	2.3 x 3.4	0.33 x 0.50
<b>3X Mini</b> Camera Tube  35-08-16-000 EFL: 600mm	FOV (mm)	NA	0.024	0.057	0.059	0.14	0.12	0.30
		Res (lp/mm)	71	170	177	420	354	900
		Mag	2.5	17	6.3	44	13	87
		DOF (mm)	1.0	0.18	0.16	0.029	0.041	0.0063
	Cam Format	1"	3.8 x 5.1	0.55 x 0.74	1.5 x 2.0	0.22 x 0.29	0.76 x 1.0	0.11 x 0.15
		4/3"	5.4 x 7.1	0.78 x 1.0	2.1 x 2.9	0.31 x 0.41	1.1 x 1.4	0.16 x 0.21
		APS-C	6.6 x 10	0.96 x 1.4	2.7 x 4.0	0.38 x 0.58	1.3 x 2.0	0.19 x 0.29
		35mm(Full)	10 x 14	1.4 x 2.1	3.8 x 5.7	0.55 x 0.83	1.9 x 2.9	0.28 x 0.41

 -- Useable FOV Limited by Coax illumination (>50% Illumination)

 -- FOV Limited by vignetting

50X M Plan Apo is NOT recommended for use with a 7:1 Zoom  
0.4X and 0.5X Camera Tubes are not recommended for use with  
a 7:1 Zoom and Microscope Objectives.

	Height	x	Width	Diag.
2/3"	6.6	x	8.8	11
1"	9.6	x	12.8	16
4/3"	13.5	x	18	22.5
APS-C*	16.7	x	25.1	30
35mm (Full)	24	x	36	43.3

\*Also known as Half Frame 35mm format

# Objectives - Mini Camera Tubes

<b>20X M Plan Apo</b> 28-21-11-001 WD: 20mm		<b>5X HiRes</b> 28-20-44-000 WD: 34mm		<b>10X HiRes</b> 28-20-45-000 WD: 19mm		<b>20X HiRes</b> 28-20-46-000 WD: 13mm	
1.2		6.4		3.1		1.7	
0.83		4.9		2.2		1.1	
Low Mag	High Mag	Low Mag	High Mag	Low Mag	High Mag	Low Mag	High Mag
0.24	0.42	0.059	0.19	0.12	0.39	0.24	0.60
708	1260	177	581	354	1163	708	1800
13	87	3.2	22	6.3	44	13	87
0.010	0.0032	0.16	0.015	0.041	0.0038	0.010	0.0016
0.52 x 0.70	0.076 x 0.10	2.1 x 2.8	0.30 x 0.40	1.0 x 1.4	0.15 x 0.20	0.52 x 0.70	0.076 x 0.10
0.76 x 1.0	0.11 x 0.15	3.0 x 4.1	0.44 x 0.59	1.5 x 2.0	0.22 x 0.29	0.76 x 1.02	0.11 x 0.15
1.1 x 1.4	0.16 x 0.21	4.3 x 5.7	0.62 x 0.83	2.1 x 2.9	0.31 x 0.41	1.1 x 1.4	0.16 x 0.21
1.3 x 2.0	0.19 x 0.29	5.3 x 8.0	0.77 x 1.2	2.7 x 4.0	0.38 x 0.58	1.3 x 2.0	0.19 x 0.29
0.24	0.42	0.059	0.19	0.12	0.39	0.24	0.60
708	1260	177	581	354	1163	708	1800
17	116	4.2	29	8.4	58	17	116
0.010	0.0032	0.16	0.015	0.041	0.0038	0.010	0.0016
0.39 x 0.52	0.057 x 0.076	1.6 x 2.1	0.23 x 0.30	0.79 x 1.0	0.11 x 0.15	0.39 x 0.52	0.057 x 0.076
0.57 x 0.76	0.083 x 0.11	2.3 x 3.0	0.33 x 0.44	1.1 x 1.5	0.17 x 0.22	0.57 x 0.76	0.083 x 0.11
0.80 x 1.1	0.12 x 0.16	3.2 x 4.3	0.47 x 0.62	1.6 x 2.1	0.23 x 0.31	0.80 x 1.1	0.12 x 0.16
0.99 x 1.5	0.14 x 0.22	4.0 x 6.0	0.58 x 0.87	2.0 x 3.0	0.29 x 0.43	0.99 x 1.5	0.14 x 0.22
0.24	0.42	0.059	0.19	0.12	0.39	0.24	0.60
708	1260	177	581	354	1163	708	1800
21	145	5.3	36	11	73	21	145
0.010	0.0032	0.16	0.015	0.041	0.0038	0.010	0.0016
0.46 x 0.61	0.066 x 0.088	1.8 x 2.4	0.26 x 0.35	0.91 x 1.2	0.13 x 0.18	0.46 x 0.61	0.066 x 0.088
0.64 x 0.86	0.093 x 0.12	2.6 x 3.4	0.37 x 0.50	1.3 x 1.7	0.19 x 0.25	0.64 x 0.86	0.093 x 0.12
0.80 x 1.2	0.12 x 0.17	3.2 x 4.8	0.46 x 0.69	1.6 x 2.4	0.23 x 0.35	0.80 x 1.2	0.12 x 0.17
1.1 x 1.7	0.17 x 0.25	4.6 x 6.9	0.66 x 0.99	2.3 x 3.4	0.33 x 0.50	1.1 x 1.7	0.17 x 0.25
0.24	0.42	0.059	0.19	0.12	0.39	0.24	0.60
708	1260	177	581	354	1163	708	1800
25	174	6.3	44	13	87	25	174
0.010	0.0032	0.16	0.015	0.041	0.0038	0.010	0.0016
0.38 x 0.51	0.055 x 0.074	1.5 x 2.0	0.22 x 0.29	0.76 x 1.0	0.11 x 0.15	0.38 x 0.51	0.055 x 0.074
0.54 x 0.71	0.078 x 0.10	2.1 x 2.9	0.31 x 0.41	1.1 x 1.4	0.16 x 0.21	0.54 x 0.71	0.078 x 0.10
0.66 x 1.0	0.096 x 0.14	2.7 x 4.0	0.38 x 0.58	1.3 x 2.0	0.19 x 0.29	0.66 x 1.0	0.096 x 0.14
0.95 x 1.4	0.14 x 0.21	3.8 x 5.7	0.55 x 0.83	1.9 x 2.9	0.28 x 0.41	0.95 x 1.4	0.14 x 0.21

**Note:** Hi Res Objectives are not flat-field and therefore limited by field curvature at lower magnifications with both fixed and zoom systems.

# Optical Performance - OPTEM 12.5:1 Zoom and Chart 3A

		<b>0.4X</b> Lower Lens 35-00-11-000 WD: 490mm EFL: 500mm		<b>0.5X</b> Lower Lens 35-00-10-000 WD: 390mm EFL: 400mm		<b>0.67X</b> Lower Lens 35-00-09-000 WD: 290mm EFL: 300mm		<b>1X</b> Lower Lens 35-00-08-000 WD: 190mm EFL: 200mm		
<b>Max FOV Dia.</b>		145		116		87		58		
<b>Max Coax FOV Dia.</b>		NR		NR		NR		20		
		<b>Low Mag</b>	<b>High Mag</b>	<b>Low Mag</b>	<b>High Mag</b>	<b>Low Mag</b>	<b>High Mag</b>	<b>Low Mag</b>	<b>High Mag</b>	
<b>0.4X</b> Camera Tube  35-08-00-000 EFL: 80mm	<b>NA</b>	0.0036	0.019	0.0045	0.024	0.0060	0.032	0.0090	0.048	
	<b>Res (lp/mm)</b>	11	58	14	72	18	96	27	144	
	<b>Mag</b>	0.045	0.55	0.056	0.69	0.075	0.92	0.11	1.4	
	<b>DOF (mm)</b>	44	1.5	28	0.98	16	0.55	7.0	0.25	
	<b>FOV (mm)</b> Cam Format	<b>1/3"</b>	80 x 107	6.5 x 8.7	64 x 86	5.2 x 7.0	48 x 64	3.9 x 5.2	32 x 43	2.6 x 3.5
		<b>1/2"</b>	107 x 143	8.7 x 12	86 x 114	7.0 x 9.3	64 x 86	5.2 x 7.0	43 x 57	3.5 x 4.6
		<b>2/3"</b>	147 x 196	12 x 16	118 x 157	9.6 x 13	88 x 118	7.2 x 9.6	59 x 79	4.8 x 6.4
<b>0.5X</b> Camera Tube  35-08-01-000 EFL: 100mm	<b>NA</b>	0.0036	0.019	0.0045	0.024	0.0060	0.032	0.0090	0.048	
	<b>Res (lp/mm)</b>	11	58	14	72	18	96	27	144	
	<b>Mag</b>	0.056	0.69	0.070	0.86	0.093	1.2	0.14	1.7	
	<b>DOF (m m)</b>	44	1.5	28	0.98	16	0.55	7.0	0.25	
	<b>FOV (mm)</b> Cam Format	<b>1/3"</b>	64 x 86	5.2 x 7.0	51 x 69	4.2 x 5.6	39 x 51	3.1 x 4.2	26 x 34	2.1 x 2.8
		<b>1/2"</b>	86 x 114	7.0 x 9.3	69 x 91	5.6 x 7.4	51 x 69	4.2 x 5.6	34 x 46	2.8 x 3.7
		<b>2/3"</b>	118 x 157	9.6 x 13	94 x 126	7.7 x 10	71 x 94	5.7 x 7.7	47 x 63	3.8 x 5.1
<b>0.6X</b> Camera Tube  35-08-02-000 EFL: 120mm	<b>NA</b>	0.0036	0.019	0.0045	0.024	0.0060	0.032	0.0090	0.048	
	<b>Res (lp/mm)</b>	11	58	14	72	18	96	27	144	
	<b>Mag</b>	0.067	0.83	0.084	1.0	0.11	1.4	0.17	2.1	
	<b>DOF (mm)</b>	44	1.5	28	0.98	16	0.55	7.0	0.25	
	<b>FOV (mm)</b> Cam Format	<b>1/3"</b>	54 x 71	4.3 x 5.8	43 x 57	3.5 x 4.6	32 x 43	2.6 x 3.5	21 x 29	1.7 x 2.3
		<b>1/2"</b>	71 x 95	5.8 x 7.7	57 x 76	4.6 x 6.2	43 x 57	3.5 x 4.6	29 x 38	2.3 x 3.1
		<b>2/3"</b>	98 x 131	8.0 x 11	79 x 105	6.4 x 8.5	59 x 79	4.8 x 6.4	39 x 52	3.2 x 4.3
<b>0.8X</b> Camera Tube  35-08-04-000 EFL: 160mm	<b>NA</b>	0.0036	0.019	0.0045	0.024	0.0060	0.032	0.0090	0.048	
	<b>Res (lp/mm)</b>	11	58	14	72	18	96	27	144	
	<b>Mag</b>	0.090	1.1	0.11	1.4	0.15	1.8	0.22	2.8	
	<b>DOF (mm)</b>	44	1.5	28	0.98	16	0.55	7.0	0.25	
	<b>FOV (mm)</b> Cam Format	<b>1/3"</b>	40 x 54	3.3 x 4.3	32 x 43	2.6 x 3.5	24 x 32	2.0 x 2.6	16 x 21	1.3 x 1.7
		<b>1/2"</b>	54 x 71	4.3 x 5.8	43 x 57	3.5 x 4.6	32 x 43	2.6 x 3.5	21 x 29	1.7 x 2.3
		<b>2/3"</b>	74 x 98	6.0 x 8.0	59 x 79	4.8 x 6.4	44 x 59	3.6 x 4.8	29 x 39	2.4 x 3.2
<b>1X</b> Camera Tube  35-08-06-000 EFL: 200mm	<b>NA</b>	0.0036	0.019	0.0045	0.024	0.0060	0.032	0.0090	0.048	
	<b>Res (lp/mm)</b>	11	58	14	72	18	96	27	144	
	<b>Mag</b>	0.11	1.4	0.14	1.7	0.19	2.3	0.28	3.5	
	<b>DOF (mm)</b>	44	1.5	28	0.98	16	0.55	7.0	0.25	
	<b>FOV (mm)</b> Cam Format	<b>1/3"</b>	32 x 43	2.6 x 3.5	26 x 34	2.1 x 2.8	19 x 26	1.6 x 2.1	13 x 17	1.0 x 1.4
		<b>1/2"</b>	43 x 57	3.5 x 4.6	34 x 46	2.8 x 3.7	26 x 34	2.1 x 2.8	17 x 23	1.4 x 1.9
		<b>2/3"</b>	59 x 79	4.8 x 6.4	47 x 63	3.8 x 5.1	35 x 47	2.9 x 3.8	24 x 31	1.9 x 2.6

Useable FOV Limited by Coax illumination (>50% Illumination)

FOV Limited by vignetting

NR = Not recommended for Coax illumination

# Fetura+ with Lower Lens

<b>1.25X</b> Lower Lens 35-00-06-000 WD: 155mm EFL: 160mm		<b>1.43X</b> Lower Lens 35-00-05-000 WD: 135mm EFL: 140mm		<b>1.67</b> Lower Lens 35-00-04-000 WD: 110mm EFL: 120mm		<b>2X</b> Lower Lens 35-00-03-000 WD: 95mm EFL: 100mm		<b>3X</b> Lower Lens 35-00-01-000 WD: 50mm EFL: 67mm		<b>4X</b> Lower Lens 35-00-02-000 WD: 32mm EFL: 50mm	
46		41		35		29		19		15	
19		19		17		20		13		9.9	
Low Mag	High Mag	Low Mag	High Mag	Low Mag	High Mag	Low Mag	High Mag	Low Mag	High Mag	Low Mag	High Mag
0.011	0.060	0.013	0.069	0.015	0.080	0.018	0.096	0.027	0.14	0.036	0.19
34	180	39	206	45	240	54	288	81	432	108	576
0.14	1.7	0.16	2.0	0.19	2.3	0.22	2.8	0.34	4.1	0.45	5.5
4.5	0.16	3.4	0.12	2.5	0.089	1.8	0.062	0.78	0.027	0.44	0.015
26 x 34	2.1 x 2.8	23 x 30	1.8 x 2.4	19 x 26	1.6 x 2.1	16 x 21	1.3 x 1.7	11 x 14	0.87 x 1.2	8.0 x 11	0.65 x 0.87
34 x 46	2.8 x 3.7	30 x 40	2.4 x 3.2	26 x 34	2.1 x 2.8	21 x 29	1.7 x 2.3	14 x 19	1.2 x 1.5	11 x 14	0.87 x 1.2
47 x 63	3.8 x 5.1	41 x 55	3.3 x 4.5	35 x 47	2.9 x 3.8	29 x 39	2.4 x 3.2	20 x 26	1.6 x 2.1	15 x 20	1.2 x 1.6
0.011	0.060	0.013	0.069	0.015	0.080	0.018	0.096	0.027	0.14	0.036	0.19
34	180	39	206	45	240	54	288	81	432	108	576
0.18	2.2	0.20	2.5	0.23	2.9	0.28	3.5	0.42	5.2	0.56	6.9
4.5	0.16	3.4	0.12	2.5	0.089	1.8	0.062	0.78	0.027	0.44	0.015
21 x 27	1.7 x 2.2	18 x 24	1.5 x 1.9	15 x 21	1.3 x 1.7	13 x 17	1.0 x 1.4	8.6 x 11	0.70 x 0.9	6.4 x 8.6	0.52 x 0.70
27 x 37	2.2 x 3.0	24 x 32	1.9 x 2.6	21 x 27	1.7 x 2.2	17 x 23	1.4 x 1.9	11 x 15	0.9 x 1.2	8.6 x 11	0.70 x 0.93
38 x 50	3.1 x 4.1	33 x 44	2.7 x 3.6	28 x 38	2.3 x 3.1	24 x 31	1.9 x 2.6	16 x 21	1.3 x 1.7	12 x 16	0.96 x 1.3
0.011	0.060	0.013	0.069	0.015	0.080	0.018	0.096	0.027	0.14	0.036	0.19
34	180	39	206	45	240	54	288	81	432	108	576
0.21	2.6	0.24	3.0	0.28	3.5	0.34	4.1	0.50	6.2	0.67	8.3
4.5	0.16	3.4	0.12	2.5	0.089	1.8	0.062	0.78	0.027	0.44	0.015
17 x 23	1.4 x 1.9	15 x 20	1.2 x 1.6	13 x 17	1.0 x 1.4	11 x 14	0.87 x 1.2	7.1 x 10	0.58 x 0.77	5.4 x 7.1	0.43 x 0.58
23 x 30	1.9 x 2.5	20 x 27	1.6 x 2.2	17 x 23	1.4 x 1.9	14 x 19	1.2 x 1.5	10 x 13	0.77 x 1.0	7.1 x 9.5	0.58 x 0.77
31 x 42	2.6 x 3.4	28 x 37	2.2 x 3.0	24 x 31	1.9 x 2.6	20 x 26	1.6 x 2.1	13 x 17	1.1 x 1.4	9.8 x 13	0.80 x 1.1
0.011	0.060	0.013	0.069	0.015	0.080	0.018	0.096	0.027	0.14	0.036	0.19
34	180	39	206	45	240	54	288	81	432	108	576
0.28	3.5	0.32	3.9	0.37	4.6	0.45	5.5	0.67	8	0.90	11
4.5	0.16	3.4	0.12	2.5	0.089	1.8	0.062	0.78	0.027	0.44	0.015
13 x 17	1.0 x 1.4	11 x 15	0.91 x 1.2	9.6 x 13	0.78 x 1.0	8.0 x 11	0.65 x 0.87	5.4 x 7.1	0.44 x 0.58	4.0 x 5.4	0.33 x 0.43
17 x 23	1.4 x 1.9	15 x 20	1.2 x 1.6	13 x 17	1.0 x 1.4	11 x 14	0.87 x 1.2	7.1 x 10	0.58 x 0.77	5.4 x 7.1	0.43 x 0.58
24 x 31	1.9 x 2.6	21 x 28	1.7 x 2.2	18 x 24	1.4 x 1.9	15 x 20	1.2 x 1.6	10 x 13	0.80 x 1.1	7.4 x 9.8	0.60 x 0.80
0.011	0.060	0.013	0.069	0.015	0.080	0.018	0.096	0.027	0.14	0.036	0.19
34	180	39	206	45	240	54	288	81	432	108	576
0.35	4.3	0.40	4.9	0.47	5.8	0.56	6.9	0.84	10.3	1.1	14
4.5	0.16	3.4	0.12	2.5	0.089	1.8	0.062	0.78	0.027	0.44	0.015
10 x 14	0.83 x 1.1	9.0 x 12	0.73 x 0.97	7.7 x 10	0.63 x 0.83	6.4 x 8.6	0.52 x 0.70	4.3 x 5.7	0.35 x 0.46	3.2 x 4.3	0.26 x 0.35
14 x 18	1.1 x 1.5	12 x 16	0.97 x 1.3	10 x 14	0.83 x 1.1	8.6 x 11	0.70 x 0.93	5.7 x 7.6	0.46 x 0.62	4.3 x 5.7	0.35 x 0.46
19 x 25	1.5 x 2.0	17 x 22	1.3 x 1.8	14 x 19	1.1 x 1.5	12 x 16	0.96 x 1.3	7.9 x 10	0.64 x 0.85	5.9 x 7.9	0.48 x 0.64

# Optical Performance - OPTEM 12.5:1 Zoom and Chart 3B

		<b>0.4X</b> Lower Lens 35-00-11-000 WD: 490mm EFL: 500mm		<b>0.5X</b> Lower Lens 35-00-10-000 WD: 390mm EFL: 400mm		<b>0.67X</b> Lower Lens 35-00-09-000 WD: 290mm EFL: 300mm		<b>1X</b> Lower Lens 35-00-08-000 WD: 190mm EFL: 200mm		
<b>Max FOV Dia.</b>		145		116		87		58		
<b>Max Coax FOV Dia.</b>		NR		NR		NR		20		
		Low Mag	High Mag	Low Mag	High Mag	Low Mag	High Mag	Low Mag	High Mag	
<b>1.5X Mini</b> Camera Tube  35-08-13-000 EFL: 300mm	<b>NA</b>	0.0036	0.019	0.0045	0.024	0.0060	0.032	0.0090	0.048	
	<b>Res (lp/mm)</b>	11	58	14	72	18	96	27	144	
	<b>Mag</b>	0.17	2.1	0.21	2.6	0.28	3.5	0.42	5.2	
	<b>DOF (mm)</b>	44	1.5	28	0.98	16	0.55	7.0	0.25	
	<b>FOV (mm)</b> <b>Cam Format</b>	<b>2/3"</b>	39 x 52	3.2 x 4.3	31 x 42	2.6 x 3.4	24 x 31	1.9 x 2.6	16 x 21	1.3 x 1.7
		<b>1"</b>	57 x 76	4.6 x 6.2	46 x 61	3.7 x 4.9	34 x 46	2.8 x 3.7	23 x 30	1.9 x 2.5
		<b>4/3"</b>	80 x 107	6.5 x 8.7	64 x 86	5.2 x 7.0	48 x 64	3.9 x 5.2	32 x 43	2.6 x 3.5
		<b>APS-C</b>	99 x 149	8.1 x 12	80 x 120	6.5 x 9.7	60 x 90	4.8 x 7.3	40 x 60	3.2 x 4.9
	<b>2X Mini</b> Camera Tube  35-08-14-000 EFL: 400mm	<b>NA</b>	0.0036	0.019	0.0045	0.024	0.0060	0.032	0.0090	0.048
		<b>Res (lp/mm)</b>	11	58	14	72	18	96	27	144
<b>Mag</b>		0.22	2.8	0.28	3.5	0.37	4.6	0.56	6.9	
<b>DOF (m m)</b>		44	1.5	28	0.98	16	0.55	7.0	0.25	
<b>FOV (mm)</b> <b>Cam Format</b>		<b>2/3"</b>	29 x 39	2.4 x 3.2	24 x 31	1.9 x 2.6	18 x 24	1.4 x 1.9	12 x 16	0.96 x 1.3
		<b>1"</b>	43 x 57	3.5 x 4.6	34 x 46	2.8 x 3.7	26 x 34	2.1 x 2.8	17 x 23	1.4 x 1.9
		<b>4/3"</b>	60 x 80	4.9 x 6.5	48 x 64	3.9 x 5.2	36 x 48	2.9 x 3.9	24 x 32	2.0 x 2.6
		<b>APS-C</b>	75 x 112	6.1 x 9.1	60 x 90	4.8 x 7.3	45 x 67	3.6 x 5.5	30 x 45	2.4 x 3.6
<b>2.5X Mini</b> Camera Tube  35-08-15-000 EFL: 500mm		<b>NA</b>	0.0036	0.019	0.0045	0.024	0.0060	0.032	0.0090	0.048
		<b>Res (lp/mm)</b>	11	58	14	72	18	96	27	144
	<b>Mag</b>	0.28	3.5	0.35	4.3	0.47	5.8	0.70	8.6	
	<b>DOF (mm)</b>	44	1.5	28	0.98	16	0.55	7.0	0.25	
	<b>FOV (mm)</b> <b>Cam Format</b>	<b>1"</b>	34 x 46	2.8 x 3.7	27 x 37	2.2 x 3.0	21 x 27	1.7 x 2.2	14 x 18	1.1 x 1.5
		<b>4/3"</b>	48 x 64	3.9 x 5.2	39 x 51	3.1 x 4.2	29 x 39	2.3 x 3.1	19 x 26	1.6 x 2.1
		<b>APS-C</b>	60 x 90	4.8 x 7.3	48 x 72	3.9 x 5.8	36 x 54	2.9 x 4.4	24 x 36	1.9 x 2.9
		<b>35mm(Full)</b>	86 x 129	7.0 x 10	69 x 103	5.6 x 8.3	51 x 77	4.2 x 6.3	34 x 51	2.8 x 4.2
	<b>3X Mini</b> Camera Tube  35-08-16-000 EFL: 600mm	<b>NA</b>	0.0036	0.019	0.0045	0.024	0.0060	0.032	0.0090	0.048
		<b>Res (lp/mm)</b>	11	58	14	72	18	96	27	144
<b>Mag</b>		0.34	4.1	0.42	5.2	0.56	6.9	0.84	10	
<b>DOF (mm)</b>		44	1.5	28	0.98	16	0.55	7.0	0.25	
<b>FOV (mm)</b> <b>Cam Format</b>		<b>1"</b>	29 x 38	2.3 x 3.1	23 x 30	1.9 x 2.5	17 x 23	1.4 x 1.9	11 x 15	0.93 x 1.2
		<b>4/3"</b>	40 x 54	3.3 x 4.3	32 x 43	2.6 x 3.5	24 x 32	2.0 x 2.6	16 x 21	1.3 x 1.7
		<b>APS-C</b>	50 x 75	4.0 x 6.1	40 x 60	3.2 x 4.9	30 x 45	2.4 x 3.6	20 x 30	1.6 x 2.4
		<b>35mm(Full)</b>	71 x 107	5.8 x 8.7	57 x 86	4.6 x 7.0	43 x 64	3.5 x 5.2	29 x 43	2.3 x 3.5

Useable FOV Limited by Coax illumination (>50% Illumination)

FOV Limited by vignetting

NR = Not recommended for Coax illumination

	Height	x	Width	Diag.
<b>2/3"</b>	6.6	x	8.8	11
<b>1"</b>	9.6	x	12.8	16
<b>4/3"</b>	13.5	x	18	22.5
<b>APS-C*</b>	16.7	x	25.1	30
<b>35mm (Full)</b>	24	x	36	43.3

\*Also known as Half Frame 35mm format



# Fetura+ with Lower Lens - Mini Camera Tubes

<b>1.25X</b> Lower Lens 35-00-06-000 WD: 155mm EFL: 160mm		<b>1.43X</b> Lower Lens 35-00-05-000 WD: 135mm EFL: 140mm		<b>1.67</b> Lower Lens 35-00-04-000 WD: 110mm EFL: 120mm		<b>2X</b> Lower Lens 35-00-03-000 WD: 95mm EFL: 100mm		<b>3X</b> Lower Lens 35-00-01-000 WD: 50mm EFL: 67mm		<b>4X</b> Lower Lens 35-00-02-000 WD: 32mm EFL: 50mm	
46		41		35		29		19		15	
19		19		17		20		13		9.9	
Low Mag	High Mag	Low Mag	High Mag	Low Mag	High Mag	Low Mag	High Mag	Low Mag	High Mag	Low Mag	High Mag
0.011	0.060	0.013	0.069	0.015	0.080	0.018	0.096	0.027	0.14	0.036	0.19
34	180	39	206	45	240	54	288	81	432	108	576
0.53	6.5	0.60	7.4	0.70	8.6	0.84	10	1.3	16	1.7	21
4.5	0.16	3.4	0.12	2.5	0.089	1.8	0.062	0.78	0.027	0.44	0.015
13 x 17	1.0 x 1.4	11 x 15	0.89 x 1.2	9.4 x 13	0.77 x 1.0	7.9 x 10	0.64 x 0.85	5.2 x 7.0	0.43 x 0.57	3.9 x 5.2	0.32 x 0.43
18 x 24	1.5 x 2.0	16 x 21	1.3 x 1.7	14 x 18	1.1 x 1.5	11 x 15	0.93 x 1.2	7.6 x 10	0.62 x 0.82	5.7 x 7.6	0.46 x 0.62
26 x 34	2.1 x 2.8	23 x 30	1.8 x 2.4	19 x 26	1.6 x 2.1	16 x 21	1.3 x 1.7	11 x 14	0.87 x 1.2	8.0 x 11	0.65 x 0.87
32 x 48	2.6 x 3.9	28 x 42	2.3 x 3.4	24 x 36	1.9 x 2.9	20 x 30	1.6 x 2.4	13 x 20	1.1 x 1.6	9.9 x 15	0.81 x 1.2
0.011	0.060	0.013	0.069	0.015	0.080	0.018	0.096	0.027	0.14	0.036	0.19
34	180	39	206	45	240	54	288	81	432	108	576
0.70	8.6	0.80	9.9	0.93	12	1.1	14	1.7	21	2.2	28
4.5	0.16	3.4	0.12	2.5	0.089	1.8	0.062	0.78	0.027	0.44	0.015
9.4 x 13	0.77 x 1.0	8.3 x 11	0.67 x 0.89	7.1 x 9.4	0.57 x 0.77	5.9 x 7.9	0.48 x 0.64	3.9 x 5.2	0.32 x 0.43	2.9 x 3.9	0.24 x 0.32
14 x 18	1.1 x 1.5	12 x 16	0.97 x 1.3	10 x 14	0.83 x 1.1	8.6 x 11	0.70 x 0.93	5.7 x 7.6	0.46 x 0.62	4.3 x 5.7	0.35 x 0.46
19 x 26	1.6 x 2.1	17 x 23	1.4 x 1.8	14 x 19	1.2 x 1.6	12 x 16	0.98 x 1.3	8.0 x 11	0.65 x 0.87	6.0 x 8.0	0.49 x 0.65
24 x 36	1.9 x 2.9	21 x 31	1.7 x 2.5	18 x 27	1.5 x 2.2	15 x 22	1.2 x 1.8	9.9 x 15	0.81 x 1.2	7.5 x 11	0.61 x 0.91
0.011	0.060	0.013	0.069	0.015	0.080	0.018	0.096	0.027	0.14	0.036	0.19
34	180	39	206	45	240	54	288	81	432	108	576
0.88	11	1.0	12	1.2	14	1.4	17	2.1	26	2.8	35
4.5	0.16	3.4	0.12	2.5	0.09	1.8	0.062	0.78	0.027	0.44	0.015
11 x 15	0.89 x 1.2	9.6 x 13	0.78 x 1.0	8.2 x 11	0.67 x 0.89	6.9 x 9.1	0.56 x 0.74	4.6 x 6.1	0.37 x 0.49	3.4 x 4.6	0.28 x 0.37
15 x 21	1.3 x 1.7	14 x 18	1.1 x 1.5	12 x 15	0.94 x 1.3	9.6 x 13	0.78 x 1.0	6.4 x 8.6	0.52 x 0.70	4.8 x 6.4	0.39 x 0.52
19 x 29	1.5 x 2.3	17 x 25	1.4 x 2.0	14 x 22	1.2 x 1.7	12 x 18	0.97 x 1.5	8.0 x 12	0.65 x 0.97	6.0 x 9.0	0.48 x 0.73
27 x 41	2.2 x 3.3	24 x 36	1.9 x 2.9	21 x 31	1.7 x 2.5	17 x 26	1.4 x 2.1	11 x 17	0.93 x 1.4	8.6 x 13	0.70 x 1.0
0.011	0.060	0.013	0.069	0.015	0.080	0.018	0.096	0.027	0.14	0.036	0.19
34	180	39	206	45	240	54	288	81	432	108	576
1.1	13	1.2	15	1.4	17	1.7	21	2.5	31	3.4	41
4.5	0.16	3.4	0.12	2.5	0.089	1.8	0.062	0.78	0.027	0.44	0.015
9.1 x 12	0.74 x 0.99	8.0 x 11	0.65 x 0.87	6.9 x 9.1	0.56 x 0.74	5.7 x 7.6	0.46 x 0.62	3.8 x 5.1	0.31 x 0.41	2.9 x 3.8	0.23 x 0.31
13 x 17	1.0 x 1.4	11 x 15	0.91 x 1.2	9.6 x 13	0.78 x 1.0	8.0 x 11	0.65 x 0.87	5.4 x 7.1	0.44 x 0.58	4.0 x 5.4	0.33 x 0.43
16 x 24	1.3 x 1.9	14 x 21	1.1 x 1.7	12 x 18	0.97 x 1.5	9.9 x 15	0.81 x 1.2	6.6 x 10	0.54 x 0.81	5.0 x 7.5	0.40 x 0.61
23 x 34	1.9 x 2.8	20 x 30	1.6 x 2.4	17 x 26	1.4 x 2.1	14 x 21	1.2 x 1.7	9.5 x 14	0.77 x 1.2	7.1 x 11	0.58 x 0.87

# Optical Performance - OPTEM 12.5:1 Zoom and Chart 3C

		<b>2X M Plan Apo</b> 28-21-02-001 WD: 34mm		<b>5X M Plan Apo</b> 28-21-05-001 WD: 41mm		<b>10X M Plan Apo</b> 28-21-10-000 WD: 34mm				
<b>Max FOV Dia.</b>		14		6.8		3.3				
<b>Max Coax FOV Dia.</b>		11		4.6		2.2				
		Low Mag	High Mag	Low Mag	High Mag	Low Mag	High Mag			
<b>0.4X</b> Camera Tube  35-08-00-000 EFL: 80mm	<b>NA</b>	<b>Res (lp/mm)</b>	0.018	0.057	0.045	0.14	0.090	0.30		
		<b>Mag</b>	54	170	135	420	270	900		
		<b>DOF (mm)</b>	0.22	2.8	0.56	6.9	1.1	14		
		<b>DOF (mm)</b>	1.8	0.18	0.28	0.029	0.070	0.0063		
	<b>FOV (mm)</b> <b>Cam Format</b>	<b>1/3"</b>	16 x 21	1.3 x 1.7	6.4 x 8.6	0.52 x 0.70	3.2 x 4.3	0.26 x 0.35		
		<b>1/2"</b>	21 x 29	1.7 x 2.3	8.6 x 11	0.70 x 0.93	4.3 x 5.7	0.35 x 0.46		
		<b>2/3"</b>	29 x 39	2.4 x 3.2	12 x 16	0.96 x 1.3	5.9 x 7.9	0.48 x 0.64		
		<b>0.5X</b> Camera Tube  35-08-01-000 EFL: 100mm	<b>NA</b>	<b>Res (lp/mm)</b>	0.018	0.057	0.045	0.14	0.090	0.30
				<b>Mag</b>	54	170	135	420	270	900
				<b>DOF (m m)</b>	0.28	3.5	0.70	8.6	1.4	17
<b>DOF (m m)</b>	1.8			0.18	0.28	0.029	0.070	0.0063		
<b>FOV (mm)</b> <b>Cam Format</b>	<b>1/3"</b>		13 x 17	1.0 x 1.4	5.1 x 6.9	0.42 x 0.56	2.6 x 3.4	0.21 x 0.28		
	<b>1/2"</b>		17 x 23	1.4 x 1.9	6.9 x 9.1	0.56 x 0.74	3.4 x 4.6	0.28 x 0.37		
	<b>2/3"</b>		24 x 31	1.9 x 2.6	9.4 x 13	0.77 x 1.0	4.7 x 6.3	0.38 x 0.51		
	<b>0.6X</b> Camera Tube  35-08-02-000 EFL: 120mm		<b>NA</b>	<b>Res (lp/mm)</b>	0.018	0.057	0.045	0.14	0.090	0.30
				<b>Mag</b>	54	170	135	420	270	900
				<b>DOF (mm)</b>	0.34	4.1	0.84	10	1.7	21
<b>DOF (mm)</b>		1.8		0.18	0.28	0.029	0.070	0.0063		
<b>FOV (mm)</b> <b>Cam Format</b>		<b>1/3"</b>	11 x 14	0.87 x 1.2	4.3 x 5.7	0.35 x 0.46	2.1 x 2.9	0.17 x 0.23		
		<b>1/2"</b>	14 x 19	1.2 x 1.5	5.7 x 7.6	0.46 x 0.62	2.9 x 3.8	0.23 x 0.31		
		<b>2/3"</b>	20 x 26	1.6 x 2.1	7.9 x 10	0.64 x 0.85	3.9 x 5.2	0.32 x 0.43		
		<b>0.8X</b> Camera Tube  35-08-04-000 EFL: 160mm	<b>NA</b>	<b>Res (lp/mm)</b>	0.018	0.057	0.045	0.14	0.090	0.30
				<b>Mag</b>	54	170	135	420	270	900
				<b>DOF (mm)</b>	0.45	5.5	1.1	14	2.2	28
<b>DOF (mm)</b>	1.8			0.18	0.28	0.029	0.070	0.0063		
<b>FOV (mm)</b> <b>Cam Format</b>	<b>1/3"</b>		8.0 x 11	0.65 x 0.87	3.2 x 4.3	0.26 x 0.35	1.6 x 2.1	0.13 x 0.17		
	<b>1/2"</b>		11 x 14	0.87 x 1.2	4.3 x 5.7	0.35 x 0.46	2.1 x 2.9	0.17 x 0.23		
	<b>2/3"</b>		15 x 20	1.2 x 1.6	5.9 x 7.9	0.48 x 0.64	2.9 x 3.9	0.24 x 0.32		
	<b>1X</b> Camera Tube  35-08-06-000 EFL: 200mm		<b>NA</b>	<b>Res (lp/mm)</b>	0.018	0.057	0.045	0.14	0.090	0.30
				<b>Mag</b>	54	170	135	420	270	900
				<b>DOF (mm)</b>	0.56	6.9	1.4	17	2.8	35
<b>DOF (mm)</b>		1.8		0.18	0.28	0.029	0.070	0.0063		
<b>FOV (mm)</b> <b>Cam Format</b>		<b>1/3"</b>	6.4 x 8.6	0.52 x 0.70	2.6 x 3.4	0.21 x 0.28	1.3 x 1.7	0.10 x 0.14		
		<b>1/2"</b>	8.6 x 11	0.70 x 0.93	3.4 x 4.6	0.28 x 0.37	1.7 x 2.3	0.14 x 0.19		
		<b>2/3"</b>	12 x 16	0.96 x 1.3	4.7 x 6.3	0.38 x 0.51	2.4 x 3.1	0.19 x 0.26		

 -- Useable FOV Limited by Coax illumination (>50% Illumination)

 -- FOV Limited by vignetting

50X M Plan Apo is NOT recommended for use with a 12.5:1 Zoom  
0.4X and 0.5X Camera Tubes are not recommended for use with  
a 12.5:1 Zoom and Microscope Objectives.

# Fetura+ with LWD Objectives

20X M Plan Apo 28-21-11-001 WD: 20mm		5X HiRes 28-20-44-000 WD: 34mm		10X HiRes 28-20-45-000 WD: 19mm		20X HiRes 28-20-46-000 WD: 13mm	
1.2		6.6		3.2		1.6	
0.83		5.0		2.3		1.1	
Low Mag	High Mag	Low Mag	High Mag	Low Mag	High Mag	Low Mag	High Mag
0.18	0.42	0.045	0.23	0.090	0.45	0.18	0.60
540	1260	135	675	270	1350	540	1800
2.2	28	0.56	6.9	1.1	14	2.2	28
0.018	0.0032	0.28	0.011	0.070	0.0028	0.018	0.0016
1.6 x 2.1	0.13 x 0.17	6.4 x 8.6	0.52 x 0.70	3.2 x 4.3	0.26 x 0.35	1.6 x 2.1	0.13 x 0.17
2.1 x 2.9	0.17 x 0.23	8.6 x 11	0.70 x 0.93	4.3 x 5.7	0.35 x 0.46	2.1 x 2.9	0.17 x 0.23
2.9 x 3.9	0.24 x 0.32	12 x 16	0.96 x 1.3	5.9 x 7.9	0.48 x 0.64	2.9 x 3.9	0.24 x 0.32
0.18	0.42	0.045	0.23	0.090	0.45	0.18	0.60
540	1260	135	675	270	1350	540	1800
2.8	35	0.70	8.6	1.4	17	2.8	35
0.018	0.0032	0.28	0.011	0.070	0.0028	0.018	0.0016
1.3 x 1.7	0.10 x 0.14	5.1 x 6.9	0.42 x 0.56	2.6 x 3.4	0.21 x 0.28	1.3 x 1.7	0.10 x 0.14
1.7 x 2.3	0.14 x 0.19	6.9 x 9.1	0.56 x 0.74	3.4 x 4.6	0.28 x 0.37	1.7 x 2.3	0.14 x 0.19
2.4 x 3.1	0.19 x 0.26	9.4 x 13	0.77 x 1.0	4.7 x 6.3	0.38 x 0.51	2.4 x 3.1	0.19 x 0.26
0.18	0.42	0.045	0.23	0.090	0.45	0.18	0.60
540	1260	135	675	270	1350	540	1800
3.4	41	0.84	10.4	1.7	21	3.4	41
0.018	0.0032	0.28	0.011	0.070	0.0028	0.018	0.0016
1.1 x 1.4	0.087 x 0.12	4.3 x 5.7	0.35 x 0.46	2.1 x 2.9	0.17 x 0.23	1.1 x 1.4	0.087 x 0.12
1.4 x 1.9	0.12 x 0.15	5.7 x 7.6	0.46 x 0.62	2.9 x 3.8	0.23 x 0.31	1.4 x 1.9	0.12 x 0.15
2.0 x 2.6	0.16 x 0.21	7.9 x 10	0.64 x 0.85	3.9 x 5.2	0.32 x 0.43	2.0 x 2.6	0.16 x 0.21
0.18	0.42	0.045	0.23	0.090	0.45	0.18	0.60
540	1260	135	675	270	1350	540	1800
4.5	55	1.1	14	2.2	28	4.5	55
0.018	0.0032	0.28	0.011	0.070	0.0028	0.018	0.0016
0.80 x 1.1	0.065 x 0.087	3.2 x 4.3	0.26 x 0.35	1.6 x 2.1	0.13 x 0.17	0.80 x 1.1	0.065 x 0.087
1.1 x 1.4	0.087 x 0.12	4.3 x 5.7	0.35 x 0.46	2.1 x 2.9	0.17 x 0.23	1.1 x 1.4	0.087 x 0.12
1.5 x 2.0	0.12 x 0.16	5.9 x 7.9	0.48 x 0.64	2.9 x 3.9	0.24 x 0.32	1.5 x 2.0	0.12 x 0.16
0.18	0.42	0.045	0.23	0.090	0.45	0.18	0.60
540	1260	135	675	270	1350	540	1800
5.6	69	1.4	17	2.8	35	5.6	69
0.018	0.0032	0.28	0.011	0.070	0.0028	0.018	0.0016
0.64 x 0.86	0.052 x 0.070	2.6 x 3.4	0.21 x 0.28	1.3 x 1.7	0.10 x 0.14	0.64 x 0.86	0.052 x 0.070
0.86 x 1.1	0.070 x 0.093	3.4 x 4.6	0.28 x 0.37	1.7 x 2.3	0.14 x 0.19	0.86 x 1.1	0.070 x 0.093
1.2 x 1.6	0.096 x 0.13	4.7 x 6.3	0.38 x 0.51	2.4 x 3.1	0.19 x 0.26	1.2 x 1.6	0.096 x 0.13

**Note:** Hi Res Objectives are not flat-field and therefore limited by field curvature at lower magnifications with both fixed and zoom systems.

# Optical Performance - OPTEM 12.5:1 Zoom and Chart 3D

		<b>2X M Plan Apo</b> 28-21-02-001 WD: 34mm		<b>5X M Plan Apo</b> 28-21-05-001 WD: 41mm		<b>10X M Plan Apo</b> 28-21-10-000 WD: 34mm		
<b>Max FOV Dia.</b>		14		6.8		3.3		
<b>Max Coax FOV Dia.</b>		11		4.6		2.2		
		Low Mag	High Mag	Low Mag	High Mag	Low Mag	High Mag	
<b>1.5X Mini Camera Tube</b> 35-08-13-000 EFL: 300mm	FOV (mm)	NA	0.018	0.057	0.045	0.14	0.090	0.30
		Res (lp/mm)	54	170	135	420	270	900
		Mag	0.84	10	2.1	26	4.2	52
		DOF (mm)	1.8	0.18	0.28	0.029	0.070	0.0063
	Cam Format	2/3"	7.9 x 10	0.64 x 0.85	3.1 x 4.2	0.26 x 0.34	1.6 x 2.1	0.13 x 0.17
		1"	11 x 15	0.93 x 1.2	4.6 x 6.1	0.37 x 0.49	2.3 x 3.0	0.19 x 0.25
		4/3"	16 x 21	1.3 x 1.7	6.4 x 8.6	0.52 x 0.70	3.2 x 4.3	0.26 x 0.35
		APS-C	20 x 30	1.6 x 2.4	8.0 x 12	0.65 x 0.97	4.0 x 6.0	0.32 x 0.49
<b>2X Mini Camera Tube</b> 35-08-14-000 EFL: 400mm	FOV (mm)	NA	0.018	0.057	0.045	0.14	0.090	0.30
		Res (lp/mm)	54	170	135	420	270	900
		Mag	1.1	14	2.8	35	5.6	69
		DOF (m m)	1.8	0.178	0.28	0.029	0.070	0.0063
	Cam Format	2/3"	5.9 x 7.9	0.48 x 0.64	2.4 x 3.1	0.19 x 0.26	1.2 x 1.6	0.096 x 0.13
		1"	8.6 x 11	0.70 x 0.93	3.4 x 4.6	0.28 x 0.37	1.7 x 2.3	0.14 x 0.19
		4/3"	12 x 16	0.98 x 1.3	4.8 x 6.4	0.39 x 0.52	2.4 x 3.2	0.20 x 0.26
		APS-C	15 x 22	1.2 x 1.8	6.0 x 9.0	0.48 x 0.73	3.0 x 4.5	0.24 x 0.36
<b>2.5X Mini Camera Tube</b> 35-08-15-000 EFL: 500mm	FOV (mm)	NA	0.018	0.057	0.045	0.14	0.090	0.30
		Res (lp/mm)	54	170	135	420	270	900
		Mag	1.4	17	3.5	43	7.0	86
		DOF (mm)	1.8	0.18	0.28	0.029	0.070	0.0063
	Cam Format	1"	6.9 x 9.1	0.56 x 0.74	2.7 x 3.7	0.22 x 0.30	1.4 x 1.8	0.11 x 0.15
		4/3"	9.6 x 13	0.78 x 1.0	3.9 x 5.1	0.31 x 0.42	1.9 x 2.6	0.16 x 0.21
		APS-C	12 x 18	0.97 x 1.5	4.8 x 7.2	0.39 x 0.58	2.4 x 3.6	0.19 x 0.29
		35mm(Full)	17 x 26	1.4 x 2.1	6.9 x 10	0.56 x 0.83	3.4 x 5.1	0.28 x 0.42
<b>3X Mini Camera Tube</b> 35-08-16-000 EFL: 600mm	FOV (mm)	NA	0.018	0.057	0.045	0.14	0.090	0.30
		Res (lp/mm)	54	170	135	420	270	900
		Mag	1.7	21	4.2	52	8.4	104
		DOF (mm)	1.8	0.18	0.28	0.029	0.070	0.0063
	Cam Format	1"	5.7 x 7.6	0.46 x 0.62	2.3 x 3.0	0.19 x 0.25	1.1 x 1.5	0.093 x 0.12
		4/3"	8.0 x 11	0.65 x 0.87	3.2 x 4.3	0.26 x 0.35	1.6 x 2.1	0.13 x 0.17
		APS-C	9.9 x 15	0.81 x 1.2	4.0 x 6.0	0.32 x 0.49	2.0 x 3.0	0.16 x 0.24
		35mm(Full)	14 x 21	1.2 x 1.7	5.7 x 8.6	0.46 x 0.70	2.9 x 4.3	0.23 x 0.35

Useable FOV Limited by Coax illumination (>50% Illumination)

FOV Limited by vignetting

50X M Plan Apo is NOT recommended for use with a 12.5:1 Zoom  
0.4X and 0.5X Camera Tubes are not recommended for use with  
a 12.5:1 Zoom and Microscope Objectives.

	Height	x	Width	Diag.
2/3"	6.6	x	8.8	11
1"	9.6	x	12.8	16
4/3"	13.5	x	18	22.5
APS-C*	16.7	x	25.1	30
35mm (Full)	24	x	36	43.3

\*Also known as Half Frame 35mm format

# Futura+ with LWD Objectives - Mini Camera Tubes

<b>20X M Plan Apo</b> 28-21-11-001 WD: 20mm		<b>5X HiRes</b> 28-20-44-000 WD: 34mm		<b>10X HiRes</b> 28-20-45-000 WD: 19mm		<b>20X HiRes</b> 28-20-46-000 WD: 13mm	
1.2		6.6		3.2		1.6	
0.83		5.0		2.3		1.1	
Low Mag	High Mag	Low Mag	High Mag	Low Mag	High Mag	Low Mag	High Mag
0.18	0.42	0.045	0.225	0.090	0.45	0.18	0.60
540	1260	135	675	270	1350	540	1800
8.4	104	2.1	26	4.2	52	8.4	104
0.018	0.0032	0.28	0.011	0.070	0.0028	0.018	0.0016
0.79 x 1.0	0.064 x 0.085	3.1 x 4.2	0.26 x 0.34	1.6 x 2.1	0.13 x 0.17	0.79 x 1.0	0.064 x 0.085
1.1 x 1.5	0.093 x 0.12	4.6 x 6.1	0.37 x 0.49	2.3 x 3.0	0.19 x 0.25	1.1 x 1.5	0.093 x 0.12
1.6 x 2.1	0.13 x 0.17	6.4 x 8.6	0.52 x 0.70	3.2 x 4.3	0.26 x 0.35	1.6 x 2.1	0.13 x 0.17
2.0 x 3.0	0.16 x 0.24	8.0 x 12	0.65 x 0.97	4.0 x 6.0	0.32 x 0.49	2.0 x 3.0	0.16 x 0.24
0.18	0.42	0.045	0.225	0.090	0.45	0.18	0.60
540	1260	135	675	270	1350	540	1800
11	138	2.8	35	5.6	69	11	138
0.018	0.0032	0.28	0.011	0.070	0.0028	0.018	0.0016
0.59 x 0.79	0.048 x 0.064	2.4 x 3.1	0.19 x 0.26	1.2 x 1.6	0.096 x 0.13	0.59 x 0.79	0.048 x 0.064
0.86 x 1.1	0.070 x 0.093	3.4 x 4.6	0.28 x 0.37	1.7 x 2.3	0.14 x 0.19	0.86 x 1.1	0.070 x 0.093
1.2 x 1.6	0.098 x 0.13	4.8 x 6.4	0.39 x 0.52	2.4 x 3.2	0.20 x 0.26	1.2 x 1.6	0.098 x 0.13
1.5 x 2.2	0.12 x 0.18	6.0 x 9.0	0.48 x 0.73	3.0 x 4.5	0.24 x 0.36	1.5 x 2.2	0.12 x 0.18
0.18	0.42	0.045	0.225	0.090	0.45	0.18	0.60
540	1260	135	675	270	1350	540	1800
14	173	3.5	43	7.0	86	14	173
0.018	0.0032	0.28	0.011	0.070	0.0028	0.018	0.0016
0.69 x 0.91	0.056 x 0.074	2.7 x 3.7	0.22 x 0.30	1.4 x 1.8	0.11 x 0.15	0.69 x 0.91	0.056 x 0.074
0.96 x 1.3	0.078 x 0.10	3.9 x 5.1	0.31 x 0.42	1.9 x 2.6	0.16 x 0.21	0.96 x 1.3	0.078 x 0.10
1.2 x 1.8	0.097 x 0.15	4.8 x 7.2	0.39 x 0.58	2.4 x 3.6	0.19 x 0.29	1.2 x 1.8	0.097 x 0.15
1.7 x 2.6	0.14 x 0.21	6.9 x 10	0.56 x 0.83	3.4 x 5.1	0.28 x 0.42	1.7 x 2.6	0.14 x 0.21
0.18	0.42	0.045	0.225	0.090	0.45	0.18	0.60
540	1260	135	675	270	1350	540	1800
17	207	4.2	52	8.4	104	17	207
0.018	0.0032	0.28	0.011	0.070	0.0028	0.018	0.0016
0.57 x 0.76	0.046 x 0.062	2.3 x 3.0	0.19 x 0.25	1.1 x 1.5	0.093 x 0.12	0.57 x 0.76	0.046 x 0.062
0.80 x 1.1	0.065 x 0.087	3.2 x 4.3	0.26 x 0.35	1.6 x 2.1	0.13 x 0.17	0.80 x 1.1	0.065 x 0.087
0.99 x 1.5	0.081 x 0.12	4.0 x 6.0	0.32 x 0.49	2.0 x 3.0	0.16 x 0.24	0.99 x 1.5	0.081 x 0.12
1.4 x 2.1	0.12 x 0.17	5.7 x 8.6	0.46 x 0.70	2.9 x 4.3	0.23 x 0.35	1.4 x 2.1	0.12 x 0.17

**Note:** Hi Res Objectives are not flat-field and therefore limited by field curvature at lower magnifications with both fixed and zoom systems.

# Optical Performance - Infinity Macro Lens with 2X

## Chart 4

42-35-41-000

		WD: 500mm 0.14X	WD: 400mm 0.17X	WD: 300mm 0.21X	
Max FOV Dia.		275	225	175	
Fixed Mag. 1X Camera Tube	NA	0.0061	0.0075	0.0096	
	Res (lp/mm)	18	22	29	
	Mag	0.14	0.17	0.21	
	DOF (mm)	15	10	6.2	
35-08-06-000 18mm Stop	FOV (mm) Cam Format	1/3"	26 x 35	22 x 29	17 x 23
	1/2"	35 x 47	29 x 39	23 x 30	
	2/3"	49 x 65	40 x 53	31 x 41	

		240		200		150		
		Low Mag	High Mag	Low Mag	High Mag	Low Mag	High Mag	
7:1 Zoom 1X Camera Tube	NA	0.0016	0.0053	0.0020	0.0064	0.0025	0.0083	
	Res (lp/mm)	4.8	16	5.9	19	7.5	25	
	Mag	0.057	0.39	0.070	0.48	0.090	0.62	
	DOF (mm)	220	20	148	14	90	8.3	
35-08-06-000	FOV (mm) Cam Format	1/3"	63 x 84	9.1 x 12	52 x 69	7.5 x 10	40 x 54	5.8 x 7.8
	1/2"	84 x 112	12 x 16	69 x 92	10 x 13	54 x 71	7.8 x 10	
	2/3"	116 x 154	17 x 22	95 x 126	14 x 18	74 x 98	11 x 14	

		210		175		135		
		Low Mag	High Mag	Low Mag	High Mag	Low Mag	High Mag	
12:1 Zoom 1X Camera Tube	NA	0.0012	0.0065	0.0015	0.0080	0.0019	0.010	
	Res (lp/mm)	3.7	20	4.5	24	5.8	31	
	Mag	0.038	0.47	0.046	0.57	0.060	0.74	
	DOF (mm)	378	13	255	8.9	154	5.4	
35-08-06-000	FOV (mm) Cam Format	1/3"	95 x 126	7.7 x 10	78 x 103	6.3 x 8.4	60 x 80	4.9 x 6.5
	1/2"	126 x 168	10 x 14	103 x 138	8.4 x 11	80 x 107	6.5 x 8.7	
	2/3"	173 x 231	14 x 19	142 x 190	12 x 15	111 x 147	9.0 x 12	

 -- FOV Limited by vignetting

1X Camera Tube shown. For other Camera tubes, multiply the magnification in the chart by the Camera tube mag., and divide the FOV values by the Camera tube mag. NA, Resolution, and DOF are not affected by the Camera Tube.

NOTE: Wide Angle Objective is not recommended for use with coaxial Illumination.

The Wide Angle Objective can be focused out to infinity. At WDs greater than 1m, it can be thought of as a video lens.

Fixed Mag:	
EFL:	73 *CT mag
f/#:	200/Stop Diameter*CT mag

NOTE: The Camera Tube Magnification will affect the EFL and the f/# of the video lens.

7:1 Zoom:	
EFL (low mag):	30*CT mag
EFL (high mag):	210*CT mag
f/#: (low mag):	18*CT mag
f/#: (high mag):	38*CT mag

# Lower Lens

## 35-00-03-000

WD: 200mm 0.30X	WD: 150mm 0.38X	WD: 100mm 0.50X	WD: 50mm 0.75X
125	100	75	50
0.013	0.017	0.023	0.034
40	51	68	103
0.30	0.38	0.50	0.77
3.1	2.0	1.1	0.48
12 x 16	9.6 x 13	7.1 x 9.5	4.7 x 6.3
16 x 21	13 x 17	9.5 x 13	6.3 x 8.4
22 x 29	18 x 23	13 x 17	8.6 x 11

110		85		65		43	
Low Mag	High Mag	Low Mag	High Mag	Low Mag	High Mag	Low Mag	High Mag
0.0035	0.012	0.0044	0.015	0.0059	0.020	0.0090	0.030
11	35	13	44	18	59	27	89
0.13	0.87	0.16	1.1	0.21	1.5	0.32	2.2
45	4.2	29	2.7	16	1.5	6.9	0.64
29 x 38	4.1 x 5.5	23 x 30	3.3 x 4.4	17 x 23	2.5 x 3.3	11 x 15	1.6 x 2.2
38 x 51	5.5 x 7.4	30 x 41	4.4 x 5.9	23 x 30	3.3 x 4.4	15 x 20	2.2 x 2.9
52 x 70	7.6 x 10	42 x 56	6.1 x 8.1	31 x 42	4.5 x 6.0	21 x 27	3.0 x 4.0

95		77		58		38	
Low Mag	High Mag	Low Mag	High Mag	Low Mag	High Mag	Low Mag	High Mag
0.0027	0.014	0.0034	0.018	0.0045	0.024	0.0069	0.037
8.1	43	10	54	14	73	21	110
0.084	1.0	0.11	1.3	0.14	1.7	0.21	2.6
78	2.7	50	1.7	28	0.97	12	0.42
43 x 57	3.5 x 4.6	34 x 46	2.8 x 3.7	26 x 34	2.1 x 2.8	17 x 22	1.4 x 1.8
57 x 76	4.6 x 6.2	46 x 61	3.7 x 4.9	34 x 45	2.8 x 3.7	22 x 30	1.8 x 2.4
79 x 105	6.4 x 8.5	63 x 84	5.1 x 6.8	47 x 62	3.8 x 5.1	31 x 41	2.5 x 3.3

### 12.5:1 Zoom:

EFL (low mag):	20*CT mag
EFL (high mag):	250*CT mag
f/#: (low mag):	15.5*CT mag
f/#: (high mag):	36*CT mag



# Optical Performance - Fixed Magnification SWIR

## Chart 5A

		0.5X Lower Lens 45-00-10-000 WD: 390mm EFL: 400mm			1X Lower Lens 45-00-08-000 WD: 190mm EFL: 200mm			1.25X Lower Lens 45-00-06-000 WD: 155mm EFL: 160mm			2X Lower Lens 45-00-03-000 WD: 95mm EFL: 100mm		
Max FOV Dia.		80			40			32			20		
Max Coax FOV Dia.		13			12			12			15		
0.5X Camera Tube 45-08-01-000 EFL: 100mm  8mm Stop	NA	0.010			0.020			0.025			0.040		
	Res (lp/mm)	14			28			35			56		
	Mag	0.25			0.50			0.63			1.0		
	DOF (mm)	11.77			2.94			1.88			0.74		
	FOV (mm) Cam Format	1/3"	14.4	x	19.2	7.2	x	9.6	5.8	x	7.7	3.6	x
	1/2"	19.2	x	25.6	9.6	x	12.8	7.7	x	10.2	4.8	x	6.4
	2/3"	26.4	x	35.2	13.2	x	17.6	10.6	x	14.1	6.6	x	8.8
0.8X Camera Tube 45-08-04-000 EFL: 160mm  8mm Stop	NA	0.010			0.020			0.025			0.040		
	Res (lp/mm)	14			28			35			56		
	Mag	0.40			0.80			1.0			1.6		
	DOF (mm)	11.77			2.94			1.88			0.74		
	FOV (mm) Cam Format	1/2"	12.0	x	16.0	6.0	x	8.0	4.8	x	6.4	3.0	x
	2/3"	16.5	x	22.0	8.3	x	11.0	6.6	x	8.8	4.1	x	5.5
	1"	24.0	x	32.0	12.0	x	16.0	9.6	x	12.8	6.0	x	8.0
1.0X Camera Tube 45-08-06-000 EFL: 200mm  12mm Stop	NA	0.015			0.030			0.038			0.060		
	Res (lp/mm)	21			42			52			84		
	Mag	0.50			1.00			1.25			2.00		
	DOF (mm)	5.23			1.31			0.84			0.33		
	FOV (mm) Cam Format	2/3"	13.2	x	17.6	6.6	x	8.8	5.3	x	7.0	3.3	x
	1"	19.2	x	25.6	9.6	x	12.8	7.7	x	10.2	4.8	x	6.4
	4/3"	27.0	x	36.0	13.5	x	18.0	10.8	x	14.4	6.8	x	9.0
1.5X Mini Camera Tube 45-08-13-000 EFL: 300mm  12mm Stop	NA	0.015			0.030			0.038			0.060		
	Res (lp/mm)	21			42			52			84		
	Mag	0.75			1.5			1.9			3.0		
	DOF (mm)	5.23			1.31			0.84			0.33		
	FOV (mm) Cam Format	2/3"	8.8	x	11.7	4.4	x	5.9	3.5	x	4.7	2.2	x
	1"	12.8	x	17.1	6.4	x	8.5	5.1	x	6.8	3.2	x	4.3
	4/3"	18.0	x	24.0	9.0	x	12.0	7.2	x	9.6	4.5	x	6.0
2.0X Mini Camera Tube 45-08-14-000 EFL: 400mm  12mm Stop	NA	0.015			0.030			0.038			0.060		
	Res (lp/mm)	21			42			52			84		
	Mag	1.00			2.0			2.50			4.0		
	DOF (mm)	5.23			1.31			0.84			0.33		
	FOV (mm) Cam Format	2/3"	6.6	x	8.8	3.3	x	4.4	2.6	x	3.5	1.7	x
	1"	9.6	x	12.8	4.8	x	6.4	3.8	x	5.1	2.4	x	3.2
	4/3"	13.5	x	18.0	6.8	x	9.0	5.4	x	7.2	3.4	x	4.5

Useable FOV Limited by Coax illumination (>50% Illumination)

FOV Limited by vignetting

**Note:**

- SWIR Specifications based on primary wavelength of 1177nm
- FUSION SWIR supports operating waveband from 700 - 1700 nm

	Height	x	Width	Diag.
2/3"	6.6	x	8.8	11
1"	9.6	x	12.8	16
4/3"	13.5	x	18	22.5
APS-C*	16.7	x	25.1	30
35mm (Full)	24	x	36	43.3

\*Also known as Half Frame 35mm format



# Optical Performance - OPTEM 7:1 Zoom SWIR

## Chart 5B

		<b>0.5X</b> Lower Lens 45-00-10-000 WD: 390mm EFL: 400mm		<b>1X</b> Lower Lens 45-00-08-000 WD: 190mm EFL: 200mm		<b>1.25X</b> Lower Lens 45-00-06-000 WD: 155mm EFL: 160mm		<b>2X</b> Lower Lens 45-00-03-000 WD: 95mm EFL: 100mm		
Max FOV Dia.		125		63		50		31		
Max Coax FOV Dia.		NR		19		19		19		
		Low Mag	High Mag	Low Mag	High Mag	Low Mag	High Mag	Low Mag	High Mag	
0.5X Camera Tube 45-08-01-000 EFL: 100mm	NA	0.0059	0.019	0.012	0.039	0.015	0.048	0.024	0.078	
	Res (lp/mm)	8	26	17	54	21	67	33	109	
	Mag	0.11	0.73	0.21	1.45	0.26	1.84	0.42	2.90	
	DOF (mm)	34	3.3	8.2	0.77	5.2	0.51	2.0	0.193	
	FOV (mm) Cam Format	1/3"	34 x 46	5.0 x 6.6	17 x 23	2.5 x 3.3	14 x 18	2.0 x 2.6	9 x 11	1.2 x 1.7
		1/2"	46 x 61	6.6 x 8.8	23 x 30	3.3 x 4.4	18 x 25	2.6 x 3.5	11 x 15	1.7 x 2.2
		2/3"	63 x 84	9.1 x 12.1	31 x 42	4.6 x 6.1	25 x 34	3.6 x 4.8	16 x 21	2.3 x 3.0
0.8X Camera Tube 45-08-04-000 EFL: 160mm	NA	0.0059	0.019	0.012	0.039	0.015	0.048	0.024	0.078	
	Res (lp/mm)	8	26	17	54	21	67	33	109	
	Mag	0.17	1.17	0.34	2.30	0.42	2.90	0.67	4.60	
	DOF (mm)	34	3.3	8.2	0.77	5.2	0.51	2.0	0.193	
	FOV (mm) Cam Format	1/2"	29 x 38	4.1 x 5.5	14 x 19	2.1 x 2.8	11.4 x 15	1.7 x 2.2	7.2 x 9.6	1.0 x 1.4
		2/3"	39 x 52	5.6 x 7.5	20 x 26	2.9 x 3.8	16 x 21	2.3 x 3.0	9.9 x 13	1.4 x 1.9
		1"	57 x 76	8.2 x 10.9	28 x 38	4.2 x 5.6	23 x 30	3.3 x 4.4	14.3 x 19	2.1 x 2.8
1.0X Camera Tube 45-08-06-000 EFL: 200mm	NA	0.0059	0.019	0.012	0.039	0.015	0.048	0.024	0.078	
	Res (lp/mm)	8	26	17	54	21	67	33	109	
	Mag	0.21	1.45	0.42	2.90	0.53	3.60	0.84	5.80	
	DOF (mm)	34	3.3	8.2	0.77	5.2	0.51	2.0	0.193	
	FOV (mm) Cam Format	2/3"	31 x 42	4.6 x 6.1	16 x 21	2.3 x 3.0	12.5 x 16.6	1.83 x 2.4	7.9 x 10.5	1.1 x 1.5
		1"	46 x 61	6.6 x 8.8	23 x 30	3.3 x 4.4	18.1 x 24	2.7 x 3.6	11.5 x 15.3	1.7 x 2.2
		4/3"	64 x 86	9.3 x 12.4	32 x 43	4.7 x 6.2	25 x 34	3.8 x 5.0	16.1 x 22	2.3 x 3.1
1.5X Mini Camera Tube 45-08-13-000 EFL: 300mm	NA	0.0059	0.019	0.012	0.039	0.015	0.048	0.024	0.078	
	Res (lp/mm)	8	26	17	54	21	67	33	109	
	Mag	0.32	2.18	0.63	4.40	0.79	5.40	1.26	8.70	
	DOF (mm)	34	3.3	8.2	0.77	5.2	0.51	2.0	0.193	
	FOV (mm) Cam Format	2/3"	21 x 28	3.0 x 4.0	10 x 14	1.5 x 2.0	8.4 x 11	1.2 x 1.6	5.2 x 7.0	0.8 x 1.0
		1"	30 x 40	4.4 x 5.9	15 x 20	2.2 x 2.9	12 x 16	1.8 x 2.4	7.6 x 10	1.1 x 1.5
		4/3"	43 x 57	6.2 x 8.3	21 x 29	3.1 x 4.1	17 x 23	2.5 x 3.3	11 x 14	1.6 x 2.1
2.0X Mini Camera Tube 45-08-14-000 EFL: 400mm	NA	0.0059	0.019	0.012	0.039	0.015	0.048	0.024	0.078	
	Res (lp/mm)	8	26	17	54	21	67	33	109	
	Mag	0.42	2.90	0.84	5.80	1.05	7.29	1.69	11.50	
	DOF (mm)	34	3.3	8.2	0.77	5.2	0.51	2.0	0.193	
	FOV (mm) Cam Format	2/3"	16 x 21	2.3 x 3.0	7.9 x 10	1.1 x 1.5	6.3 x 8.4	0.9 x 1.2	3.9 x 5.2	0.6 x 0.8
		1"	23 x 30	3.3 x 4.4	11 x 15	1.7 x 2.2	9.1 x 12	1.3 x 1.8	5.7 x 7.6	0.8 x 1.1
		4/3"	32 x 43	4.7 x 6.2	16 x 21	2.3 x 3.1	13 x 17	1.9 x 2.5	8.0 x 11	1.2 x 1.6

-- Useable FOV Limited by Coax illumination (>50% Illumination)

-- FOV Limited by vignetting

## FUSION Flexibility...

At the heart of FUSION's extreme versatility, is the simplicity of stacking a variety of modules to affect magnification, function, form and wavelength of the lens system.

Following are the basic required components of a functional FUSION lens assembly. From here, features and accessories are easily swapped in to meet your requirements.

**Camera Mount**  
Mates FUSION with C, CS, F, EOS, 4/3-mount cameras and more

**Camera Tube**  
Modifies magnification to your camera optimizing chip coverage & performance

**Core Optical Module**  
Determines optical function: Fixed, 7:1 or 12.5:1 zoom magnification—motorized or manual

**Lower Function Module**  
Integrates internal focus—motorized or manual—and coaxial LED illumination options

**Lower Lens**  
Modifies taking magnification to affect field of view, NA and working distance

## Modular design allows FUSION to evolve quickly and easily

With a simple change-out of a few modules, you can modify FUSION performance, function, form and wavelength to meet the evolving requirements of your system. This streamlines prototyping stages and aids the evolution of your system.



**Optem FUSION**  
Extreme Micro-Imaging Versatility





## Your Key to Photonic Innovation...

Qioptiq serves a wide variety of applications across the industrial manufacturing sector. With a rich history of delivering innovative photonic components, modules and instruments to integrators, engineers and OEMs, we also offer custom-tailored photonic solutions to maximize the potential and capabilities of tomorrow's many processes and industrial manufacturing systems.

## ...and Manufacturing Advancement

For technical information  
[www.qioptiq.com](http://www.qioptiq.com)  
[Inspection@excelitas.com](mailto:Inspection@excelitas.com)

**North America**  
Toll free: 800-724-4274

**Europe**  
Tel: +49 551 6935-0

**Asia Pacific**  
Tel: +65 6499 7766

