

Copying of this document and giving it to others and the use or communication of the contents thereof, are forbidden without express authority. Offenders are liable to the payment of damages. All rights are reserved in the event of the grant of a patent or the registration of the utility model or design.

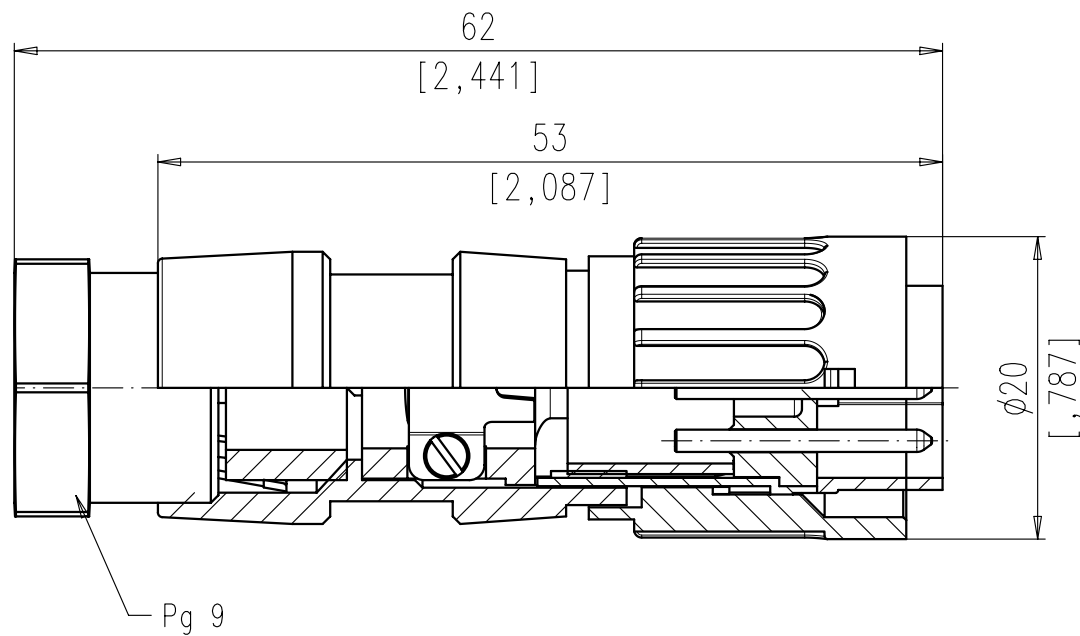

Polzahl number of contacts	Norm standard	3	4	5	5	6	7	7	8	12	14
D Kontaktanordnung nach DIN contact arrangement acc. to DIN Kontaktanordnung nach IEC contact arrangement acc. to IEC		41524 60130-9	- 60130-9	-	41524 60130-9	45322 60130-9	-	45329 60130-9	45326 60130-9	-	-
Bemessungsspannung rated voltage	IEC 60664-1	300V =		100V =	300V =		100V =		150V =		
Bemessungsspannung rated voltage	UL 1977	250V								60V	
Bemessungs-Stoßspannung rated impulse withstand voltage	IEC 60664-1	1500V		1200V	1500V		1200V				
Verschmutzungsgrad pollution degree	IEC 60664-1	1									
Überspannungskategorie installation category	IEC 60664-1	I									
Isolierstoffgruppe insulation group	IEC 60664-1	II, 400 ≤ CTI < 600									
Strombelastbarkeit current rating	IEC 60512-5-2 Test 5b UL 1977	5A / +40°C / +104°F								3A / +40°C / +104°F	
Isolationswiderstand insulation resistance	IEC 60512-3-1 Test 3a	>10 ¹⁰ Ω									
Durchgangswiderstand contact resistance	IEC 60512-2-1 Test 2a	< 5m Ω									
Prüfklasse climatic category	IEC 60068-1	40 / 100 / 56									
Temperaturbereich temperatur range	IEC 60068-1	-40°C ... +100°C -40°F ... +212°F									
B IP-Schutzart IP-degree	IEC 60529	IP 40									
Steck- und Ziehkraft Insertion and withdrawal forces	IEC 60512-13-2 Test 13b	25N 90.oz	30N 110.oz	35N 125.oz	50N 180.oz	55N 200.oz	60N 220.oz	50N 180.oz			
Mechanische Lebensdauer mechanical operation	IEC 60512-9-1 Test 9a	gold/gold ≥ 1000 Steckzyklen/mating cycles									
Werkstoff Gehäuse housing material		Überwurfmutter Messing, Zugentlastung Zink-Druckguß, Oberfläche vernickelt coupling ring brass, strain relief, die cast, nickel plated									
Werkstoff Kontaktträger dielectric material		Thermoplast thermoplastic									
Kontaktoberfläche contact plating		vergoldet * gold plated									
Anschlussstechnik termination technique		löten solder								löten solder	
A Anschlussquerschnitt wire gauge		löten/solder ≤ 0,5 mm ² / 20AWG								≤ 0,25 mm ² / 24 AWG	
Brennbarkeit flammability		UL 94 V0									
Verriegelung locking system		Bajonett bayonet									

	14	T 3644 528
	12	T 3624 528
	8 IEC	T 3524 528
	7 IEC	T 3444 528
	7	T 3434 528
	6	T 3424 528
	5	T 3374 528
	5 IEC	T 3394 528
	4	T 3324 528
	3	T 3274 528
SYMBOL symbol	POLZAHL number of contacts	TYP-NUMMER-AU type-number-AU

Diese Steckverbinder dürfen betriebsmäßig nicht unter Spannung betätigt werden. Metallene Gehäuseteile sind sicher mit dem Schutzleitersystem zu verbinden.
 Do not connect or disconnect under load. Metal housing parts shall be securely incorporated to protected ground.

* Hinweis für vergoldete Anschlüsse:
 Zur Vermeidung von spröden intermetallischen Verbindungen müssen vergoldete Anschlüsse vor dem eigentlichen Lötvorgang verzinnt werden.

Remark for gold plated contacts:
 In order to avoid brittle inter-metallic connections, gold-plated terminals have to be tin-plated in the solder area.

Gewicht (errechnet)/ Calc WT:	9	Zul. Abw./Tolerances:		Maßstab/Scale	2:1	A3	
Prüfmaß/Test dimension				CUSTOMER DRAWING			
Teileindex Part index number				08	Datum/Date	Name	
				Gez.	04.07.	Cionvica	Kabelstecker gerade Male cable connector
				Drawn			
				Gepf.			
				Checked			
				Amphenol-Tuchel Electronics GmbH			Blatt/Sheet 1
01	200700144	04.07.08	CI	M HB T 3XX4 528			1 Bl.
Index	Änderung/Description	Datum/Date	Name	Ers. f./Similar to:			