

Water Leak Detector 61F-GPN-V50

CSM_61F-GPN-V50_DS_E_5_5

Flexible Setup according to Water Quality and Surrounding Wiring Conditions

- The operating resistance has a variable sensitivity from 0 to 50 k Ω , so the best set values can be made according to the predicted water leakage, degree of overflow, water quality, or surrounding wiring conditions.
- The power supplied to the Sensing Band is 24 VAC, so operation is stable because there is no electrode deterioration from electrical corrosion.
- A contact signal output enables monitoring from remote locations.



[Reference]

For detecting leakage of water with high resistivity, use K7L-U/-UD ultra high-sensitivity models.

 Refer to *Safety Precautions for Floatless Level Controllers*.

Ordering Information

Water Leak Detector	61F-GPN-V50
---------------------	-------------

When ordering, to complete the part number, be sure to specify the desired operating voltage.

Example: 61F-GPN-V50 [120/240 VAC]

_____ Desired supply voltage

Specifications

■ Ratings/Characteristics

Item	Water Leak Detector
Model	61F-GPN-V50
Supply voltage	24, 110, 120, 220, 230, 240 VAC
Operating voltage range	85% to 110% of rated voltage
Interelectrode voltage	24 VAC
Operating current	3 mA (AC) max.
Power consumption	3.2 VA max.
Sensitivity	Variable (0 to 50 k Ω)
Sensitivity error	Scale 0: 0 to 10 k Ω * Scale 50: 50 \pm 10 k Ω
Contact ratings	3 A 250 VAC, DPDT cos ϕ =1 1 A 250 VAC, DPDT cos ϕ =0.4
Indicator	Provided (Operation indicator)
Alarm buzzer	Not provided
Test switch	Not provided
Ambient temperature	-10 to 50°C
Ambient humidity	45% to 85%
Accessories	Hold-down clip PFC-N8
Approved standards	UL508 CSA C22.2 No.14 EN61010-1 EN61326-1 Industrial electromagnetic environment

* The Detector may not operate around the setting value of "0." Adjust the sensitivity depending on the actual application.

Operation

Internal Circuit

Connections

61F-GPN-V50 Water Leak Detector

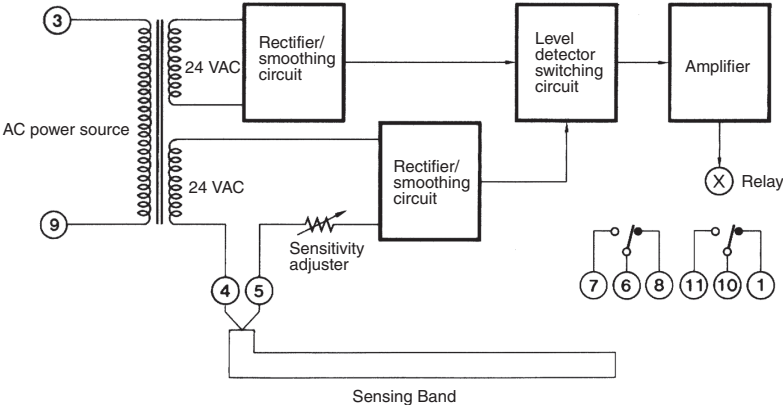

61F-GPN-V50 Water Leak Detector

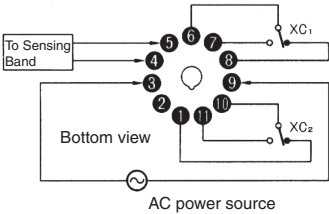

Operating Principle

When the two conductive cores of the Sensing Band are contacted by a liquid, a weak alternating current (as small as 3 mA max.) flows across the cores. This current is amplified to operate a relay.

In practice, leakage will be detected if water drops are present between the core wire and the Electrode (F03-15 Sensing Band) or detecting section (F03-16PE Sensing Band). (Refer to the specifications on page 4)

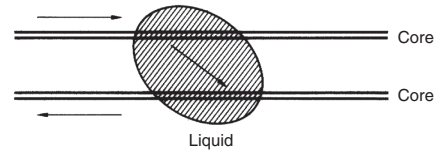

Sensing Band Protective Cover

Item	F03-25	F03-26PES
Appearance		
Suggested use		
Construction		
Comments	<p>Secures the F03-15 Sensing Band to the floor surface. Attach the sticker on a smooth surface. To attach it on a concrete floor, use a concrete bonding agent.</p>	<p>Secures the F03-16PE Sensing Band to the floor surface. Attach the sticker on a smooth surface. To attach it on a concrete floor, use a concrete bonding agent.</p>

Dimensions

Note: All units are in millimeters unless otherwise indicated.

61F-GPN-V50 Water Leak Detector

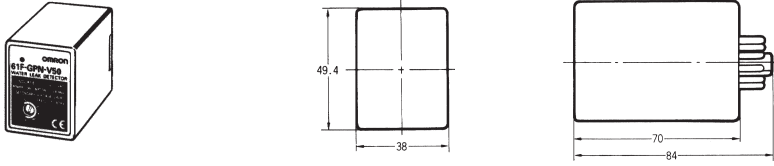

■ Accessories (Order Separately)

Connecting Sockets (for 61F-GPN-V50 Water Leak Detector)

PF113A-E Track-mounted Socket

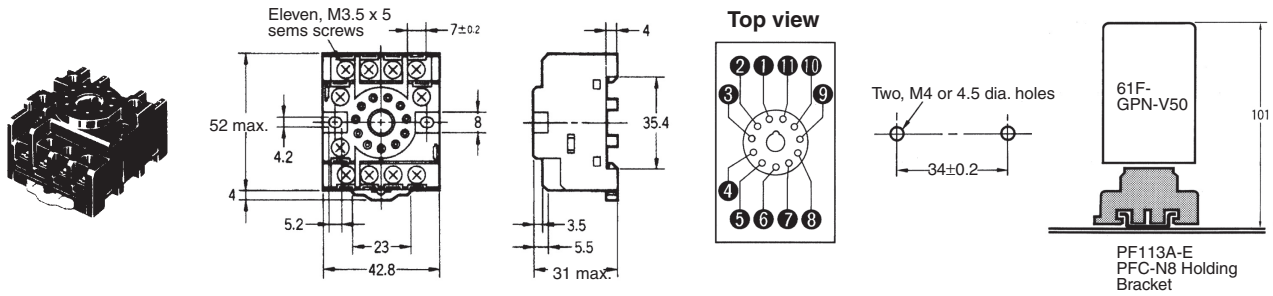

PL11 Back-connecting Socket

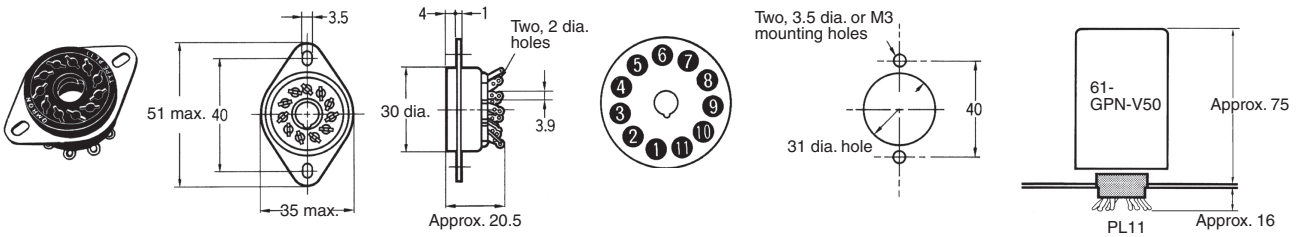

Important: Install the Water Leak Detector socket with the keyway facing down.

Sensing Band

F03-15

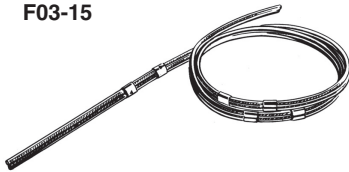

Sheath: Transparent vinyl chloride
Core: Stainless steel SUS304

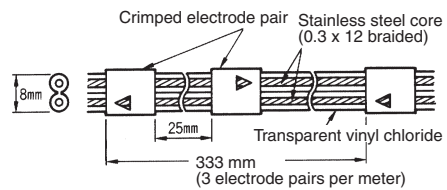

F03-16PE

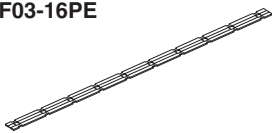

Sheath: Transparent vinyl chloride
Core: Stainless steel SUS316

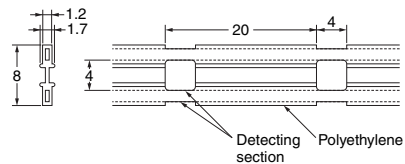

Safety Precautions

⚠ WARNING

Do not touch the terminals while power is being supplied. Doing so may possibly result in electric shock. Make sure that the terminal cover is installed before using the product.



⚠ CAUTION

Do not attempt to disassemble, repair, or modify the product. Doing so may occasionally result in minor or moderate injury due to electric shock.



■ Precautions for Safe Use

- (1) Use only F03-15 or F03-16 Sensing Band. Other water conductors may cause the Water Leak Alarm/Detector to malfunction, or not operate at all because of mismatched sensitivity.
- (2) Place the Sensing Band at a location where water leakage is most likely to occur. For example, consider the following locations:
 - Under a raised floor; on the highest floor of a building; on the ceiling
 - In the vicinity of an air conditioner, or on the floor near a humidifier
 - On the floor near a feed-water pipe, conduit; hot-water pipe.
 - On top of a power, or control panel
- (3) Secure the Sensing Band so that they touch the floor surface or the wall near a pipe arrangement. Cover the Sensing Band with a F03-25 or F03-26 Protective Cover if they are installed at a location crowded with people. However, place the cover such a manner that water can easily reach the Sensing Band.
- (4) Keep the temperature at the installation site to within 55°C. Do not install the Water Leak Alarm/Detector/Sensing Band in the proximity of heat-generating equipment (such as that having a coil or wire winding). Also, do not use it in a highly humid location, or at a location that is subjected to corrosive gases. Do not place the Water Leak Alarm/Detector side-by-side with a high-capacity contactor that produces an inrush current when it operates, as such arrangement may cause chattering to occur, consequently causing a malfunction of the Water Leak Alarm/Detector.
- (5) Wiring distance of the Sensing Band varies depending on the water quality. When using IV cables, wire the Sensing Band to the length specified in the following table.
- (6) Mount the 61F-WLA Water Leak Alarm/Detector on a sturdy wall surface which is not subjected to vibration or shock. Do not use double-sided adhesive tape, otherwise, the Detector may detach when the adhesive tape deteriorates due to aging.
- (7) When wiring the Sensor on conductive objects like metal objects, use the F03-16.
- (8) When measuring insulation resistance, do not conduct a megger test between the electrode terminals.

IV Cable	Sensing Band
0 m	200 m
10 to 150 m	150 m
200 to 300 m	100 m
350 to 400 m	50 m

Note: IV cable: 2 mm²

ALL DIMENSIONS SHOWN ARE IN MILLIMETERS.

To convert millimeters into inches, multiply by 0.03937. To convert grams into ounces, multiply by 0.03527.

In the interest of product improvement, specifications are subject to change without notice.

Terms and Conditions Agreement

Read and understand this catalog.

Please read and understand this catalog before purchasing the products. Please consult your OMRON representative if you have any questions or comments.

Warranties.

(a) Exclusive Warranty. Omron's exclusive warranty is that the Products will be free from defects in materials and workmanship for a period of twelve months from the date of sale by Omron (or such other period expressed in writing by Omron). Omron disclaims all other warranties, express or implied.

(b) Limitations. OMRON MAKES NO WARRANTY OR REPRESENTATION, EXPRESS OR IMPLIED, ABOUT NON-INFRINGEMENT, MERCHANTABILITY OR FITNESS FOR A PARTICULAR PURPOSE OF THE PRODUCTS. BUYER ACKNOWLEDGES THAT IT ALONE HAS DETERMINED THAT THE PRODUCTS WILL SUITABLY MEET THE REQUIREMENTS OF THEIR INTENDED USE.

Omron further disclaims all warranties and responsibility of any type for claims or expenses based on infringement by the Products or otherwise of any intellectual property right. (c) Buyer Remedy. Omron's sole obligation hereunder shall be, at Omron's election, to (i) replace (in the form originally shipped with Buyer responsible for labor charges for removal or replacement thereof) the non-complying Product, (ii) repair the non-complying Product, or (iii) repay or credit Buyer an amount equal to the purchase price of the non-complying Product; provided that in no event shall Omron be responsible for warranty, repair, indemnity or any other claims or expenses regarding the Products unless Omron's analysis confirms that the Products were properly handled, stored, installed and maintained and not subject to contamination, abuse, misuse or inappropriate modification. Return of any Products by Buyer must be approved in writing by Omron before shipment. Omron Companies shall not be liable for the suitability or unsuitability or the results from the use of Products in combination with any electrical or electronic components, circuits, system assemblies or any other materials or substances or environments. Any advice, recommendations or information given orally or in writing, are not to be construed as an amendment or addition to the above warranty.

See <http://www.omron.com/global/> or contact your Omron representative for published information.

Limitation on Liability: Etc.

OMRON COMPANIES SHALL NOT BE LIABLE FOR SPECIAL, INDIRECT, INCIDENTAL, OR CONSEQUENTIAL DAMAGES, LOSS OF PROFITS OR PRODUCTION OR COMMERCIAL LOSS IN ANY WAY CONNECTED WITH THE PRODUCTS, WHETHER SUCH CLAIM IS BASED IN CONTRACT, WARRANTY, NEGLIGENCE OR STRICT LIABILITY.

Further, in no event shall liability of Omron Companies exceed the individual price of the Product on which liability is asserted.

Suitability of Use.

Omron Companies shall not be responsible for conformity with any standards, codes or regulations which apply to the combination of the Product in the Buyer's application or use of the Product. At Buyer's request, Omron will provide applicable third party certification documents identifying ratings and limitations of use which apply to the Product. This information by itself is not sufficient for a complete determination of the suitability of the Product in combination with the end product, machine, system, or other application or use. Buyer shall be solely responsible for determining appropriateness of the particular Product with respect to Buyer's application, product or system. Buyer shall take application responsibility in all cases.

NEVER USE THE PRODUCT FOR AN APPLICATION INVOLVING SERIOUS RISK TO LIFE OR PROPERTY OR IN LARGE QUANTITIES WITHOUT ENSURING THAT THE SYSTEM AS A WHOLE HAS BEEN DESIGNED TO ADDRESS THE RISKS, AND THAT THE OMRON PRODUCT(S) IS PROPERLY RATED AND INSTALLED FOR THE INTENDED USE WITHIN THE OVERALL EQUIPMENT OR SYSTEM.

Programmable Products.

Omron Companies shall not be responsible for the user's programming of a programmable Product, or any consequence thereof.

Performance Data.

Data presented in Omron Company websites, catalogs and other materials is provided as a guide for the user in determining suitability and does not constitute a warranty. It may represent the result of Omron's test conditions, and the user must correlate it to actual application requirements. Actual performance is subject to the Omron's Warranty and Limitations of Liability.

Change in Specifications.

Product specifications and accessories may be changed at any time based on improvements and other reasons. It is our practice to change part numbers when published ratings or features are changed, or when significant construction changes are made. However, some specifications of the Product may be changed without any notice. When in doubt, special part numbers may be assigned to fix or establish key specifications for your application. Please consult with your Omron's representative at any time to confirm actual specifications of purchased Product.

Errors and Omissions.

Information presented by Omron Companies has been checked and is believed to be accurate; however, no responsibility is assumed for clerical, typographical or proofreading errors or omissions.