

Valid for contact arrangement:
05b, 07b, 08a, 12a, 14a

Valid for contact arrangement:
03a, 04a, 05a, 06a, 07a

Panel cutout M 1:1

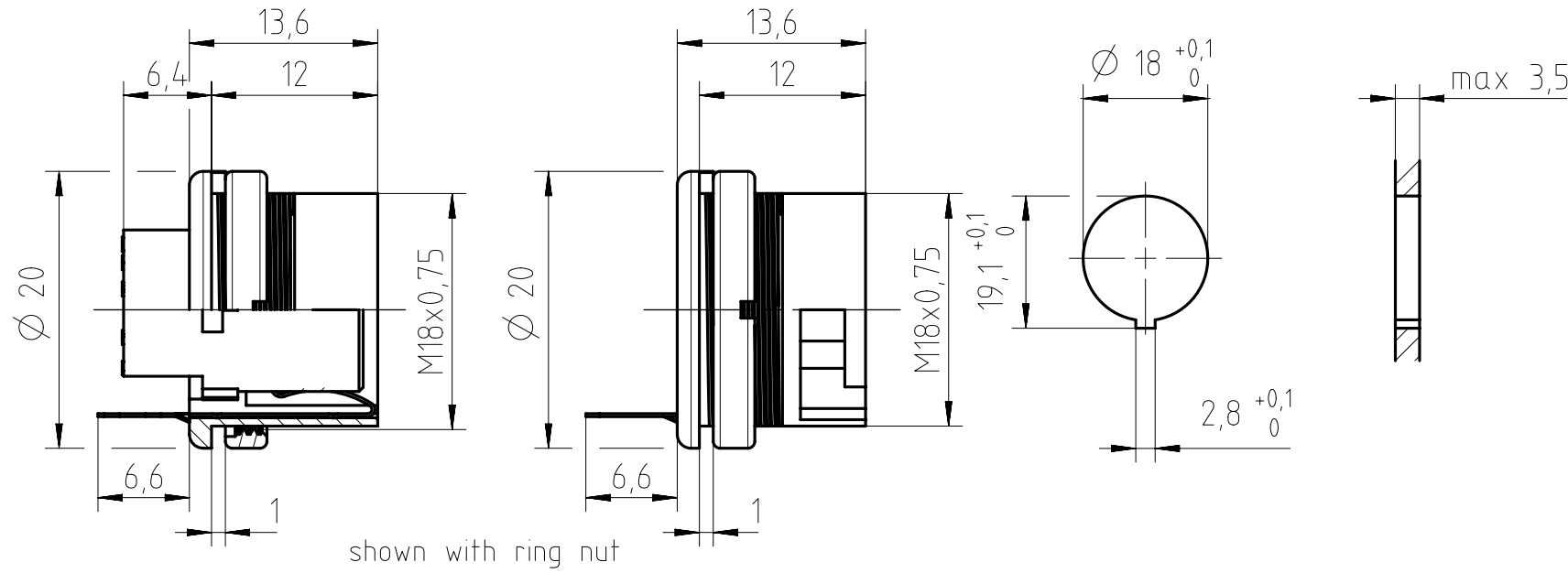

	14 (14-a)	T 3647 150 U	T 3647 159 U
	12 (12-a)	T 3627 150 U	T 3627 159 U
	8 (08-a)	T 3527 150 U	T 3527 159 U
	7 (07-b)	T 3447 150 U	T 3447 159 U
	7 (07-a)	T 3437 150 U	T 3437 159 U
	6 (06-a)	T 3427 150 U	T 3427 159 U
	5 (05-b)	T 3397 150 U	T 3397 159 U
	5 (05-a)	T 3377 150 U	T 3377 159 U
	4 (04-a)	T 3327 150 U	T 3327 159 U
	3 (03-a)	T 3277 150 U	T 3277 159 U

Number of contacts	Standard	3	4	5	5S	6	7	7	8	12	14	
Contact arrangement	DIN EN 61076-2-106	03-a	04-a	05-a	05-b	06-a	07-a	07-b	08-a	12-a	14-a	
Contact arrangement	IEC 60130-9 ¹⁾			-								
Rated voltage	IEC 60664-1	300 V (100 V)	300 V (63 V)	100 V (32 V)	300 V (63 V)	100 V (32 V)	150 V (32 V)					
Rated voltage	UL 1977	250 V						60 V				
Rated impulse withstand voltage	IEC 60664-1	1500 V (840 V)		1200 V (500 V)	1500 V (840 V)		1200 V (500 V)					
Pollution degree	IEC 60664-1	1 (2)										
Installation category	IEC 60664-1	I										
Insulation group	IEC 60664-1	II, 400 ≤ CTI < 600										
Current rating	IEC 60512-5-2 UL 1977	10A/+40°C		7A/+40°C/+104°F				3A/+40°C/+104°F				
Insulation resistance	IEC 60512-3-1	>10 ¹⁰ Ohm ²⁾										
Contact resistance	IEC 60512-2-1	<5m Ohm										
Climatic category	IEC 60668-1	40 / 100 / 56										
Temperatur range	IEC 60668-1	-40°C...+100°C / -40°F...+212°F										
IP degree	IEC 60529	IP 40										
Insertion and withdrawal force	IEC 60512-13-2	25N	30N	35N	50N	55N	60N	50N				
Mechanical operation	IEC 60512-9-1	silver ≥500 mating cycles gold ≥1000 mating cycles										
Housing material		brass or zinc die cast nickel plated or thermoplast										
Dielectric material		thermoplastic										
Contacts		silver or gold plated, please order contacts separately acc. to drawing M-N 02 015 00XX X (3-8pol) or M-N 02 010 0157 X U (12-14pol)										
Termination technique		crimp										
Wire gauge		2-6 pol (exclusive 5S): 0,09-1,0mm ² / 28-18 AWG				0,09-0,25mm ² / 28-24 AWG						
Flamability		UL 94 V0										
locking system		bayonet locking outside (mateable with locking inside)										

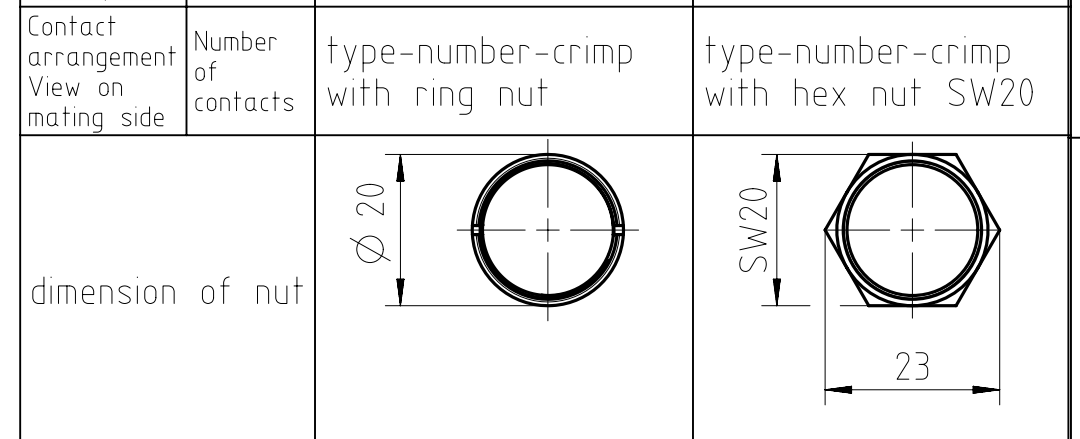

Gewicht (errechnet) / Calc WT:		Zul. Abw./Tolerances:		Maßstab / Scale: 2:1;1:1		A3	
Prüfmaß / Testdimension		ISO 2768-c		DIN / ISO 13715		CUSTOMER DRAWING	
Teileindex / Partindexnumber:		Bagatelle change:		Gez. 28.04.2020		Gerätedose	
				Drawn MCARLE		female receptacle	
				Status Released			
				Gepr. 30.04.2020			
				Checked MGRIMM			
				Amphenol Tuchel Industrial GmbH		Blatt / Sheet 1	
01 202000001		30.04.2020		MCARLE		M NB T 3XX7 15X U	
Index		Änderung / Description		Datum / Date		Name	
						Ers. f. / Replacement for: M-NB T 3XX7 150 Rev01	

¹⁾ Edition 2000-05
²⁾ under operating conditions >10⁸ Ohm
All technical data have been measured in a laboratory environment and can be different during practical usage of the product. Any product information is for descriptive usage only and not legally binding; particularly the information does not constitute or provide any legal guaranties. Do not connect or disconnect under load. Metal housing parts shall be securely incorporated to protected ground. Parts according to directive 2002/95/EG (RoHS).

Copying of this document and giving it to others and the use or communication of the contents thereof, are forbidden without express authority. Offenders are liable to the payment of damages. All rights are reserved in the event of the grant of a patent or the registration of the utility model or design.

Weitergabe sowie Vervielfältigung dieser Unterlage, Verwertung und Mitteilung ihres Inhalts nicht gestattet, soweit nicht ausdrücklich zugestanden. Zuwiderhandlungen verpflichten zu Schadenersatz. Alle Rechte für den Fall der Patenterteilung oder Gebrauchsmuster-Eintragung vorbehalten.