

# WSK-900-0005

## HVAC System Monitoring Kit, Cellular Interface

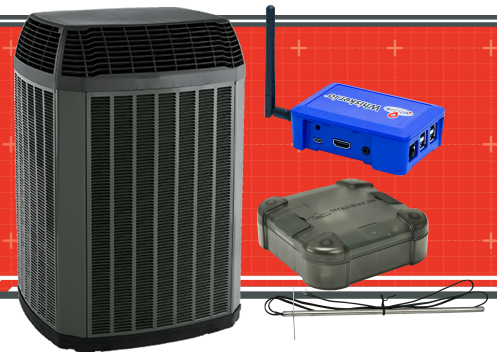

### General Description

This kit contains a complete IoT sensor network. It is the ideal solution to remotely monitor an entire HVAC system. It features the Smart.Hub (Pro, Cellular version) with power supply and antennas for cloud connectivity and (3) Whisker.Block® sensor modules. The first Whisker.Block® is for measuring ambient (room) temperature.







The second Whisker.Block® is configured for monitoring the compressor unit. It features:

- A current transformer input for a 25 amp current transformer.
- Dual external temperature Probes.
- An internal temperature sensor to measure the ambient temperature of the Whisker.Block® location.

The third Whisker.Block® is configured for monitoring the temperatures in air ducts. It consists of:

- Dual external temperature probes designed for duct mounting.
- A dry contact switch input.
- An internal temperature sensor to measure the ambient temperature of the Whisker.Block® location.

This bundle contains the following components:

Quantity	Part Number	Description	
1	WH1-9-00-PDNCN-N	Smart.Hub™ Pro, Cellular Interface Whisker.io™, Smart.Hub™, Pro, 900MHz, Cellular, 120VAC	
1	WB1-9-00-NNNNNNNN-0000-LR	Whisker.Block®, Internal Temp 900MHz, battery powered, int. antenna, int. temperature	
1	WB1-9-00-C2TRTRNN-0000-LR	Whisker.Block®, HVAC Current/Dual Temp Probe 900MHz, battery powered, int. antenna, int. temperature, ext. 0-25A current trans. input qty. (1), 10K Thermistor Input qty. (2)	
1	WB1-9-00-TRTRNNNN-0000-LR	Whisker.Block®, Int. Temp & Dual 10KO Thermistor Input 900MHz, battery powered, int. antenna, int. temperature, ext. 10K thermistor qty. (2)	
1	WBP_SC_0005_01	Sensor Cable / Current XFMR / Thermistor	
1	WBP_SC_0005_02	Sensor Cable / Thermistor	
1	WBP_SC_0005_03	Sensor Cable / 2 Duct Mount Thermistors	

# WH1-9-00-PDNCN-N

## Smart.Hub™ Pro, Cellular Interface

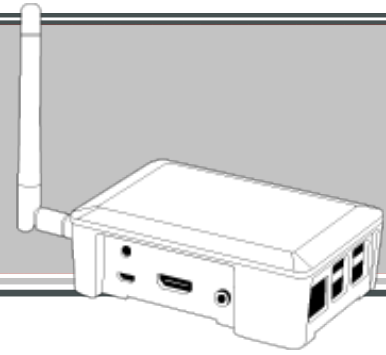

### General Description

The Smart.Hub™ Pro is a versatile and reliable IOT gateway device for use in indoor applications. Smart.Hub™ products are gateways used to move data from Whisker.Block® sensor blocks and end user customized Whisker.Engine™ based sensor nodes to the Whisker.io™ cloud platform.

### Features

- Plug and play operation
- Ethernet & Cellular options
- Data buffering during loss of connectivity
- Supports all Whisker.io Cloud services
- Works with 3rd party platforms via Whisker.io Forwarding
- Supports two-way communication with field devices – monitor and control
- Communicate with field devices over distances more than 1.6 kilometers.

### Robustness and Reliability

If the hub loses connectivity to the Internet, it will buffer all incoming messages from field devices to storage on the SD card. When hub connectivity is restored, the messages will be sent to the cloud for storage and forwarding. In the event of catastrophic failure, the data on the SD card can be recovered using our Data Recovery App (Windows).

### Throughput

The number of devices that can be supported by this hub varies with the reporting rate of the connected devices. This is a single channel hub, which ultimately determines its limitations; with a single channel, this hub can process about 1,800 messages an hour. The following table estimates device capacity for several different update rates.

Update Rate	Estimated number of devices
5 Minutes	250
1 Hour	1500
4 Hours	5000
24 Hours	10000

This hub supports two-way communications with field devices that support the Whisker.io™ protocol. For battery powered devices, the hub will queue down-stream messages (commands) and send them to the device when it reports in at its sampling interval; therefore, the command latency is equivalent to the update rate of the device. For line powered devices, commands are sent immediately, with a latency of less than 1 second.

### Whisker.io Services

#### Storage



Devices that are configured with the storage service will persist their historic data in the Whisker.io cloud, making it available for visualization and analysis using our Whisker.io™ Portal web-based software.

#### Alerting



Rules based alerting allows a text or email to be sent when the specified condition is met and when it clears.

#### Dashboard



Secure, user friendly dashboard with visualization through gauges, graphs, sensor signal strength and fuel gauges.

#### Forwarding



The forwarding service allows two-way communications between Whisker.io devices and third party platforms such as Amazon, ThingLogix, etc.



## Mechanical

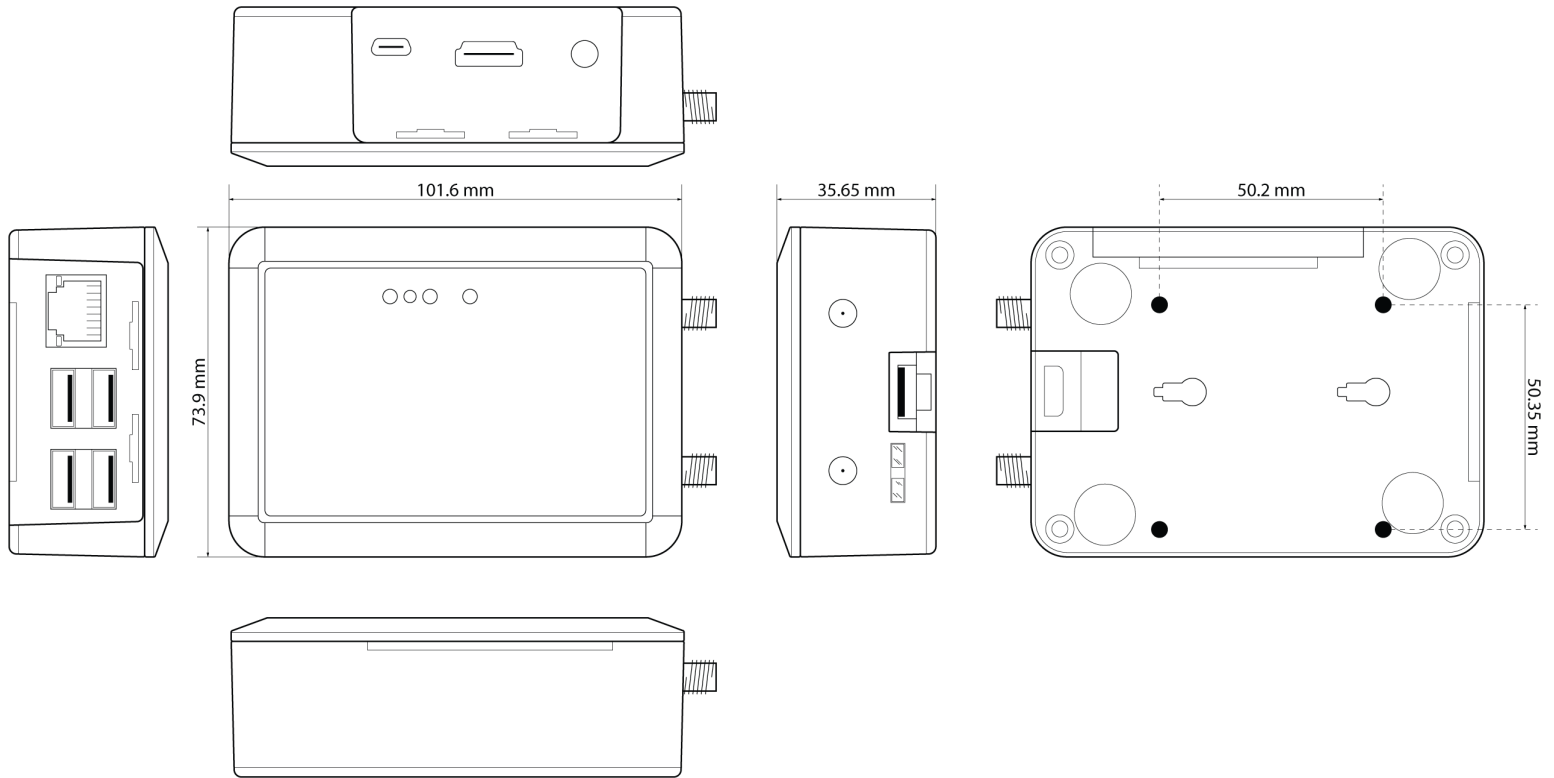

## Connectivity Options

Every Whisker.io™ Hub can connect to the Internet via Ethernet. Hubs that are purchased with the Cellular option can also connect via Cellular.

## Installation and Setup

All Whisker.io™ hubs are truly plug-and-play, requiring no provisioning or setup in the field. Simply mount the hub, connect it to power, and wait for all the status lights to come on.

Once a hub is installed, it is automatically configured to work with devices within its transmission range.

## Order Information

Part Number	Description
WH1-9-00-PDNCN-N	Whisker.io™, Smart.Hub™, Pro, 900MHz, Cellular, 120VAC



**Whisker.io™**

WB1-9-00-NNNNNNNN-0000-LR

Whisker.Block®, Internal Temp

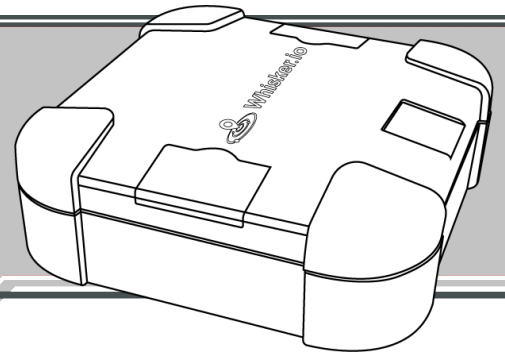

## General Description

Whisker.Blocks® are long-range, wireless sensors that come in a variety of I/O and power configurations. These sensor blocks use our proprietary long range wireless communication technology, ensuring reliable and robust operation.

They can be configured for battery or external power. When powered from internal batteries, the sensors can operate for 10 or more years, depending on the sensors use and configuration. Each sensor is housed in a durable, IP67 enclosure that supports a variety of mounting methods. External sensors are connected via one or two 4-pin M8 style waterproof connectors, depending on how many external channels are configured.

The long range, exceptional battery life, and flexible I/O configurations of the Whisker.Block® make it the perfect choice for nearly any IoT application.

## Power

This Whisker.Block® is powered internally using a 3.7V, 5.2A-H LiThCl battery pack that should give 10+ years of service life before a battery change is required, assuming a 5 minute update period.

## Range

They come in a variety of configurations with multiple external channels for various analog and digital inputs. In an unobstructed, outdoor line-of-site environment, the sensor should be able to communicate for more than 0.8 kilometers assuming a receiving antenna elevation of 3.0 meters. If the receiving antenna is raised to 6.1 meters or more, the range should increase to more than 1.6 kilometers.

When used in environments where line of sight cannot be obtained or where there are many reflective obstacles in the transmission path, the range will degrade due to multi-path fading. It is impossible to predict the transmission range of a Whisker.Block® in any specific situation, so we do encourage users to take advantage of our site survey tools to ensure coverage exists anywhere a sensor is to be deployed. For more information on site survey techniques, see application note .

## Internal Channels

This Whisker.Block® is configured with two (2) internal channels:



**Battery Voltage**



**Ambient Temperature**

## External Connections

This Whisker.Block® has no configured external channels

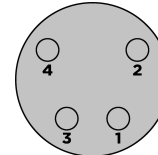

Con 2: Not used

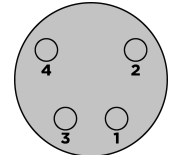

Con 2: Not used





## Mechanical

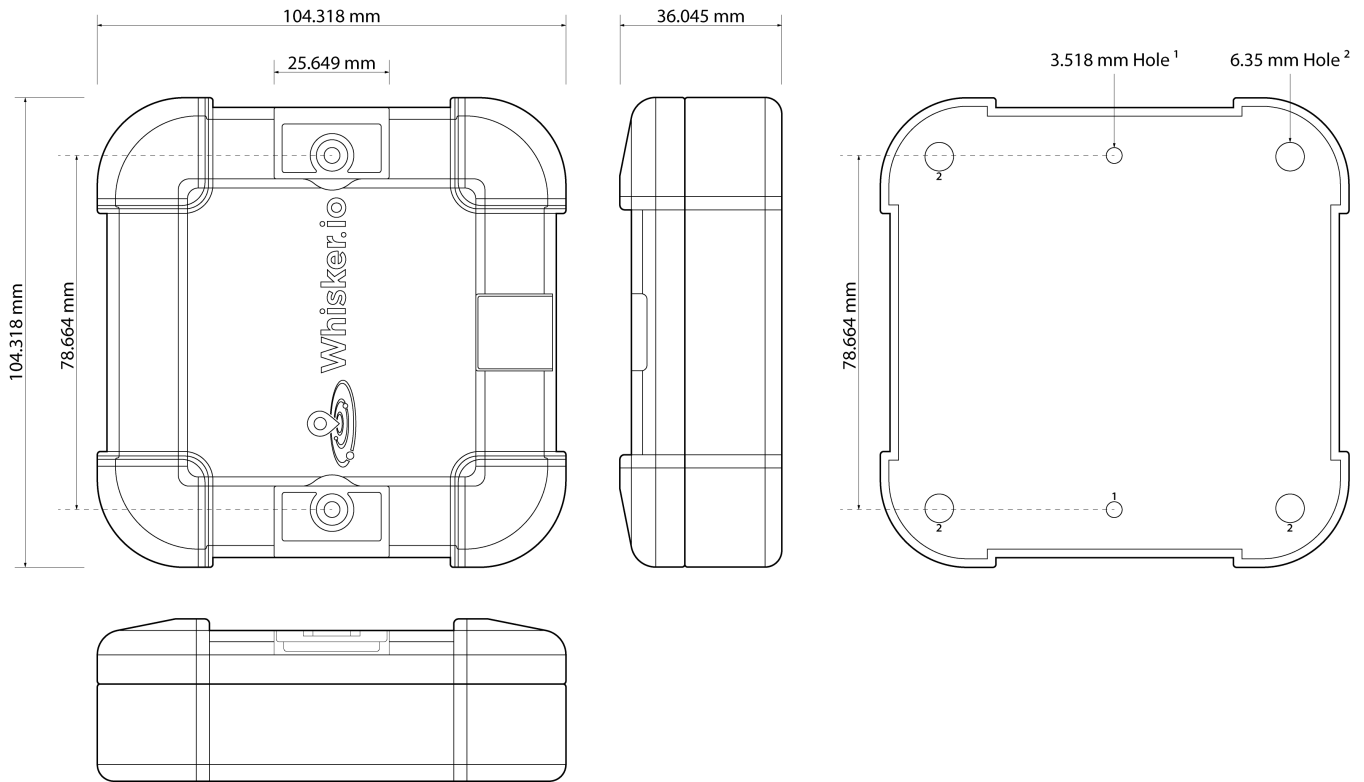

## Electrical Specifications

Parameter	Minimum	Typical	Maximum	Units
Battery Life—Standard Pack	N/A	10	20	Years
Operating Temp. Range	-40		+85	Degrees Celsius
Transmission Range		0.8-1.6		kilometers <sup>1</sup>
Frequency Range	902		928	MHz
Internal Temperature Measurement Range	-40		+85	Degrees Celsius
Internal Temperature Measurement Accuracy	-1		1	Degrees Celsius
Sensor Sample Rate		5		Minutes

1) Typical range: Outdoors, line of sight, unobstructed, antenna elevation 3 meters. Max range: Outdoors, line of sight, unobstructed, antenna elevation 12 meters

## Order Information

Part Number	Description
WB1-9-00-NNNNNNNN-0000-LR	900MHz, battery powered, int. antenna, int. temperature



**Whisker.io™**

# WB1-9-00-C2TRTRNN-0000-LR

Whisker.Block®, HVAC Current/Dual Temp Probe

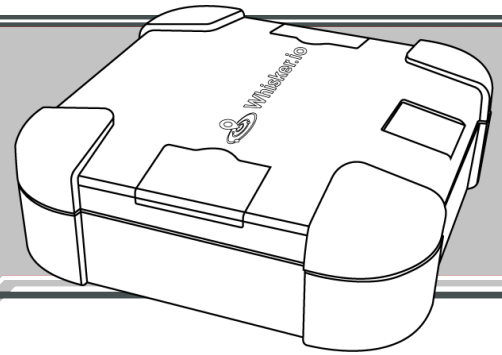

## General Description

Whisker.Blocks® are long-range, wireless sensors that come in a variety of I/O and power configurations. These sensor blocks use our proprietary long range wireless communication technology, ensuring reliable and robust operation.

They can be configured for battery or external power. When powered from internal batteries, the sensors can operate for 10 or more years, depending on the sensors use and configuration. Each sensor is housed in a durable, IP67 enclosure that supports a variety of mounting methods. External sensors are connected via one or two 4-pin M8 style waterproof connectors, depending on how many external channels are configured.

The long range, exceptional battery life, and flexible I/O configurations of the Whisker.Block® make it the perfect choice for nearly any IoT application.

## Power

This Whisker.Block® is powered internally using a 3.7V, 5.2A-H LiThCl battery pack that should give 10+ years of service life before a battery change is required, assuming a 5 minute update period.

## Range

They come in a variety of configurations with multiple external channels for various analog and digital inputs. In an unobstructed, outdoor line-of-site environment, the sensor should be able to communicate for more than 0.8 kilometers assuming a receiving antenna elevation of 3.0 meters. If the receiving antenna is raised to 6.1 meters or more, the range should increase to more than 1.6 kilometers.

When used in environments where line of sight cannot be obtained or where there are many reflective obstacles in the transmission path, the range will degrade due to multi-path fading. It is impossible to predict the transmission range of a Whisker.Block® in any specific situation, so we do encourage users to take advantage of our site survey tools to ensure coverage exists anywhere a sensor is to be deployed. For more information on site survey techniques, see application note .

## Internal Channels

This Whisker.Block® is configured with two (2) internal channels:



**Battery Voltage**



**Ambient Temperature**

## External Connections

This Whisker.Block® is configured with three (3) external channels:

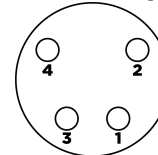

Con 2 (Left)

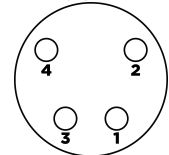

Con 1 (Right)

Connector	Pin	Function	Description
1	1	Vout	Switched output voltage
1	2	Channel 1	C.T. Input
1	3	Channel 2	10K Thermister Input
1	4	Ground	Circuit ground
2	1	Vout	Switched output voltage
2	2	Channel 3	10K Thermister Input
2	3	Not used	Not used
2	4	Ground	Circuit ground



## Mechanical

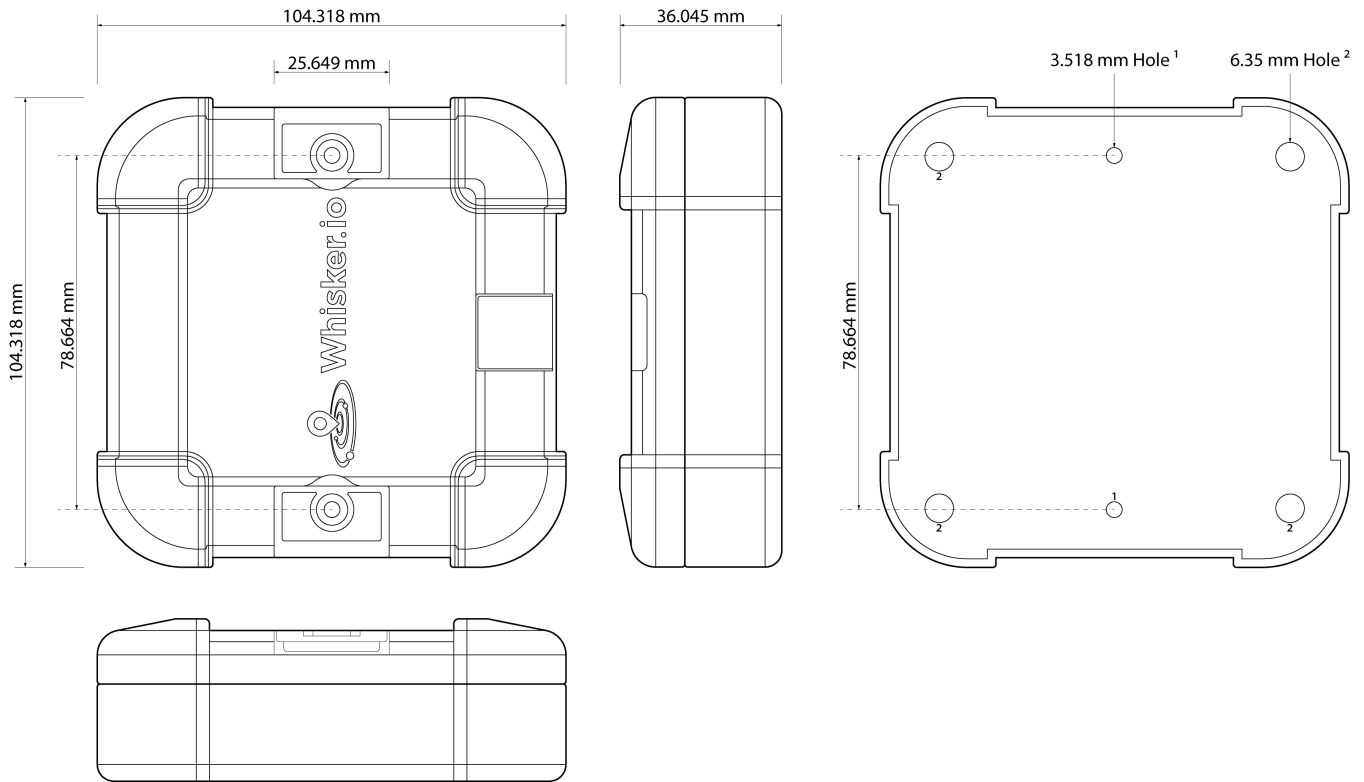

## Electrical Specifications

Parameter	Minimum	Typical	Maximum	Units
Battery Life—Standard Pack	N/A	10	20	Years
Operating Temp. Range	-40		+85	Degrees Celsius
Transmission Range		0.8	>8.1	kilometers <sup>1</sup>
Frequency Range	902		928	MHz
Internal Temperature Measurement Range	-40		+85	Degrees Celsius
Internal Temperature Measurement Accuracy	-1		1	Degrees Celsius
Sensor Sample Rate		5		Minutes
Analog input voltage range	4		20	mA
Sensor Voltage supply		4.096		VDC
Sensor Supply Current			20	mA
Current Input <sup>2</sup>	0		25	Amps A.C.
Thermal Resistance		10K		ohms

1) Outdoors, line of sight, unobstructed, antenna elevation 3 meters

2) Using a C.T. with a 0-5V DC output scaled for 0-25Amps such as our CT-SCT010T-25A (Supplied with Block)

## Order Information

Part Number	Description
WB1-9-00-C2TRTRNN-0000-LR	900MHz, battery powered, int. antenna, int. temperature, ext. 0-25A current trans. input qty. (1), 10K Thermister Input qty. (2)



**Whisker.io™**

# WB1-9-00-TRTRNNNN-0000-LR

Whisker.Block®, Int. Temp & Dual 10K Thermistor Input

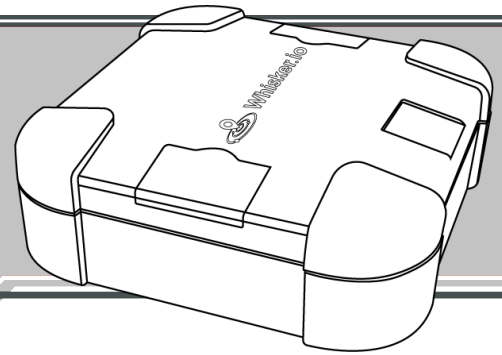

## General Description

Whisker.Blocks® are long-range, wireless sensors that come in a variety of I/O and power configurations. These sensor blocks use our proprietary long range wireless communication technology, ensuring reliable and robust operation.

They can be configured for battery or external power. When powered from internal batteries, the sensors can operate for 10 or more years, depending on the sensors use and configuration. Each sensor is housed in a durable, IP67 enclosure that supports a variety of mounting methods. External sensors are connected via one or two 4-pin M8 style waterproof connectors, depending on how many external channels are configured.

The long range, exceptional battery life, and flexible I/O configurations of the Whisker.Block® make it the perfect choice for nearly any IoT application.

## Power

This Whisker.Block® is powered internally using a 3.7V, 5.2A-H LiThCl battery pack that should give 10+ years of service life before a battery change is required, assuming a 5 minute update period.

## Range

They come in a variety of configurations with multiple external channels for various analog and digital inputs. In an unobstructed, outdoor line-of-site environment, the sensor should be able to communicate for more than 0.8 kilometers assuming a receiving antenna elevation of 3.0 meters. If the receiving antenna is raised to 6.1 meters or more, the range should increase to more than 1.6 kilometers.

When used in environments where line of sight cannot be obtained or where there are many reflective obstacles in the transmission path, the range will degrade due to multi-path fading. It is impossible to predict the transmission range of a Whisker.Block® in any specific situation, so we do encourage users to take advantage of our site survey tools to ensure coverage exists anywhere a sensor is to be deployed. For more information on site survey techniques, see application note .

## Internal Channels

This Whisker.Block® is configured with two (2) internal channels:



**Battery Voltage**



**Ambient Temperature**

## External Connections

This Whisker.Block® is configured with two (2) external channels:

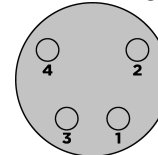

Con 2: Not used

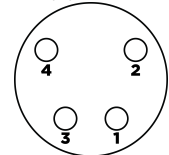

Con 1 (Right)

Connector	Pin	Function	Description
1	1	Vout	Switched output voltage
1	2	Channel 1	10K Thermistor Input
1	3	Channel 2	10K Thermistor Input
1	4	Ground	Circuit ground



## Mechanical

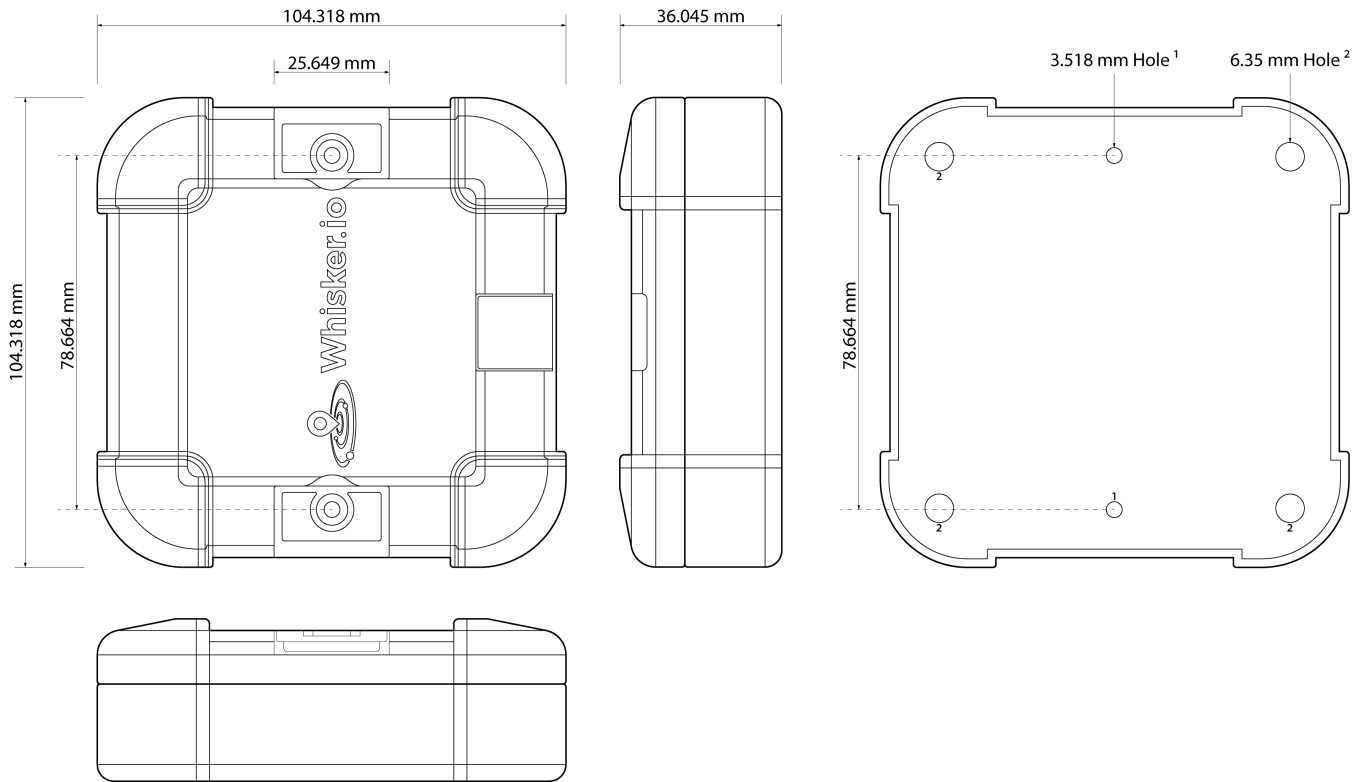

## Electrical Specifications

Parameter	Minimum	Typical	Maximum	Units
Battery Life—Standard Pack	N/A	10	20	Years
Operating Temp. Range	-40		+85	Degrees Celsius
Transmission Range		0.8	>8.1	kilometers <sup>1</sup>
Frequency Range	902		928	MHz
Internal Temperature Measurement Range	-40		+85	Degrees Celsius
Internal Temperature Measurement Accuracy	-1		1	Degrees Celsius
Sensor Sample Rate		5		Minutes
Analog input voltage range	4		20	mA
Sensor Voltage supply		4.096		VDC
Sensor Supply Current			20	mA
Thermal Resistance <sup>2</sup>		10K		ohms

1) Outdoors, line of sight, unobstructed, antenna elevation 3 meters

2) This Whisker.Block<sup>®</sup> is configured for external 10K thermistor(s)

## Order Information

Part Number	Description
WB1-9-00-TRTRNNNN-0000-LR	900MHz, battery powered, int. antenna, int. temperature, ext. 10K thermistor qty. (2)



**Whisker.io™**

# WBP\_SC\_0005\_01

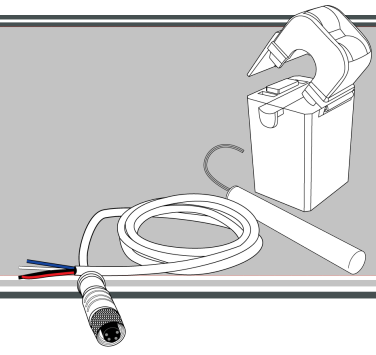

Sensor Cable / Current XFMR / Thermistor



## General Description

This cable kit contains a base Sensor Attachment Cable that is connected to the sensor block. The below listed components are shipped attach to the listed Sensor Attachment Cable as shown in the below diagram.

This bundle contains the following components:

Quantity	Part Number	Description	
1	WBP-TR-01-3F	8cm Thermistor Temperature Probe, 91cm Cable	
1	WBP-CT2-01-3F	0-25A A.C. Current Transformer	
1	CBL_M8MALE26AWG_3FT_01	Sensor Attachment Cable, 91cm Cable Blue/No Marker = Channel 1, Yellow Marker = Channel 2	

## Wiring Diagram

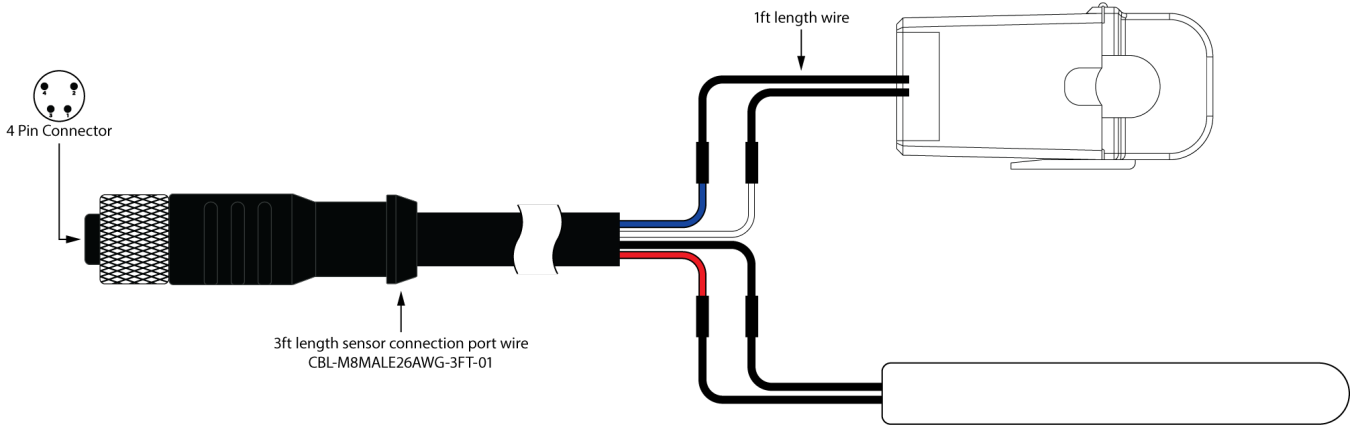

# WBP-TR-01-3F

8cm Thermistor Temperature Probe, 91cm Cable

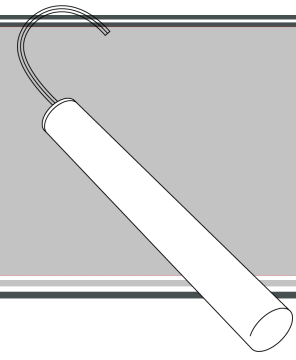

## General Description

Whisker.Blocks® are long-range, wireless sensors that come in a variety of I/O and power configurations. These sensor blocks use our proprietary long range wireless communication technology, ensuring reliable and robust operation. They come in a variety of configurations with multiple external channels for various analog and digital inputs.

This external sensor is designed to work with a Whisker.Block® that is configured with an external thermistor (TR) input. When properly mounted, this sensor can detect temperatures in the range of -40°C to +85°C.

The thermistor is contained within a 8cm stainless steel housing that can be used in air, food products, and most liquids. It is available with a 15cm and 91cm cable.

We offer other temperatures probe configurations that can be used in a variety of applications. The WBP-TR-02-xx is a 13cm version of this probe, the WBP-TR-03-xx is designed to be mounted in HVAC ducts, and finally the WBP-TR-04-xx is a lug mounted probe that can be used on equipment such as motors.

## Power

Power for the sensor is provided by the Whisker.Block®.

## Mounting

The sensor is housed in a 6.1mm round by 8cm long stainless steel tube.

It should be mounted so that the bottom half the tube is fully submerged in the medium you are monitoring.

Take care not to crimp or otherwise damage the stainless steel tube as that might adversely affect proper operation or might shorten the operating life of the sensor.

## Compatible Whisker.Blocks®

Part Number
WB1-9-00-DCTRNNNN-0000-LR
WB1-9-00-DCTRTRNN-0000-LR
WB1-9-00-C1TRTRNN-0000-LR
WB1-9-00-C2TRTRNN-0000-LR
WB1-9-00-C3TRTRNN-0000-LR
WB1-9-00-C4TRTRNN-0000-LR

## Wiring

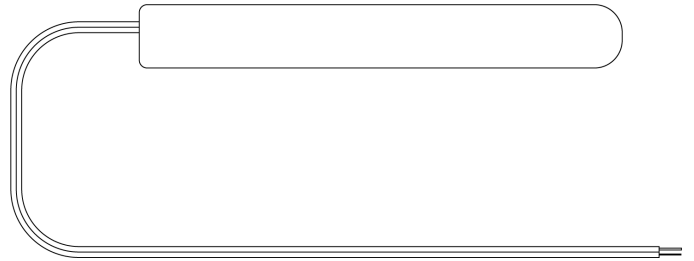

### Recommended Wiring:

Connector	Pin	Sensor Wire	Description
1	1	Red	Sensor power supply
1	2 or 3	Blue/Black	Thermister output



# WBP-CT2-01-3F

0-25A A.C. Current Transformer, 91cm Cable

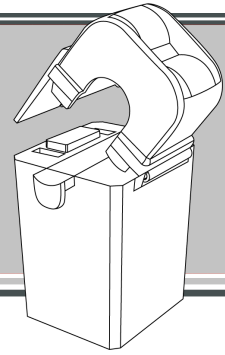

## General Description

Whisker.Blocks® are long-range, wireless sensors that come in a variety of I/O and power configurations. These sensor blocks use our proprietary long range wireless communication technology, ensuring reliable and robust operation. They come in a variety of configurations with multiple external channels for various analog and digital inputs.

This external current transformer is designed to work with a Whisker.Block® that is configured with a 25 amp current Transformer (C2) input with 0-5VDC output. When properly mounted, this sensor will detect current from 0 to 25 amps A.C.

## Power

This is a passive sensor that requires no external power.

## Mounting

This current transformer is connected to the D6 CBL-M8MALE26AWG wire harness as shown in the wiring diagram. This sensor is housed in a padlock type assembly that is clamped around the AC power line that is to be monitored.

## Electrical Specifications

Parameter	Minimum	Typical	Maximum	Units
Rated Input Current (Continuous)			25	Amps A.C.
Max Input(1 Min)			37.5	Amps A.C.
Rated Output			5	VDC
Output Ripple Voltage			5% output voltage	
Accuracy	±2%			
Output Impedance		7		k
Isolation Impedance (500VDC)	100			M
Working Voltage			660	Volts
Working Temp	-25°C		+60°C	Degrees Celsius
Storage Temp	-30°C		+90°C	Degrees Celsius
Frequency Range	50		60	Hz
Dielectric Strength (50Hz, 1Min)			3.5	KV

## Compatible Whisker.Blocks®

### Part Number

WB1-9-00-C2NNNNNN-0000-LR

WB1-9-00-C2TRTRNN-0000-LR

## Wiring

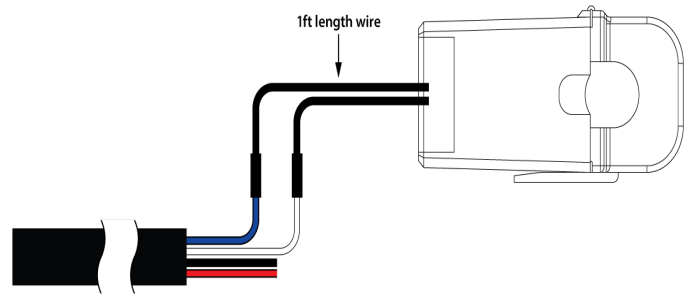

### Recommended Wiring:

Connector	Pin	Sensor Wire	Description
1	2	Blue	0-5V Analog In
1	4	White	Ground Reference





# CBL\_M8MALE26AWG\_3FT\_01

Sensor Attachment Cable, 91cm Cable

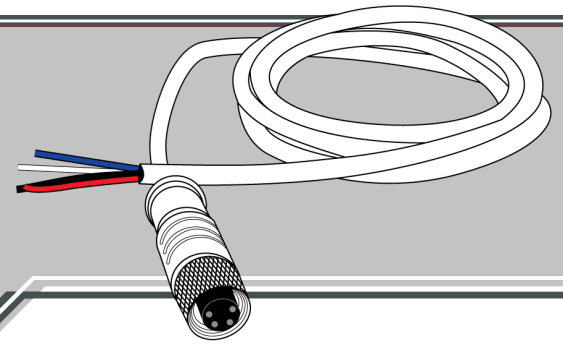

## General Description

Whisker.Blocks® are long-range, wireless sensors that come in a variety of I/O and power configurations. These sensor blocks use our proprietary long range wireless communication technology, ensuring reliable and robust operation. They come in a variety of configurations with multiple external channels for various analog and digital inputs.

The Sensor Attachment Cable is installed on the Whisker.Block® to provide a means to connect up to two (2) sensors to the Whisker.Block® without having to wire the sensor(s) directly to the Whisker.Block® circuit board connector.

## Mounting

The Sensor Attachment Cable comes attached to the Whisker.Block®. In some cases, the sensors must be connected to the Sensor Attachment Cable using the wiring configuration shown on the sensor data sheet.

## Compatible Whisker.Blocks®

Part Number
WB1-9-00-A5NNNNNN-0000-LR
WB1-9-00-C1NNNNNN-0000-LR
WB1-9-00-C2NNNNNN-0000-LR
WB1-9-00-C3NNNNNN-0000-LR
WB1-9-00-C4NNNNNN-0000-LR
WB1-9-00-C1TRTRNN-0000-LR
WB1-9-00-C2TRTRNN-0000-LR
WB1-9-00-C3TRTRNN-0000-LR
WB1-9-00-C4TRTRNN-0000-LR
WB1-9-00-C2TRTRNN-0000-LR
WB1-9-00-DCNNNNNN-0000-LR
WB1-9-00-TRNNNNNN-0000-LR
WB1-9-00-TRTRNNNN-0000-LR

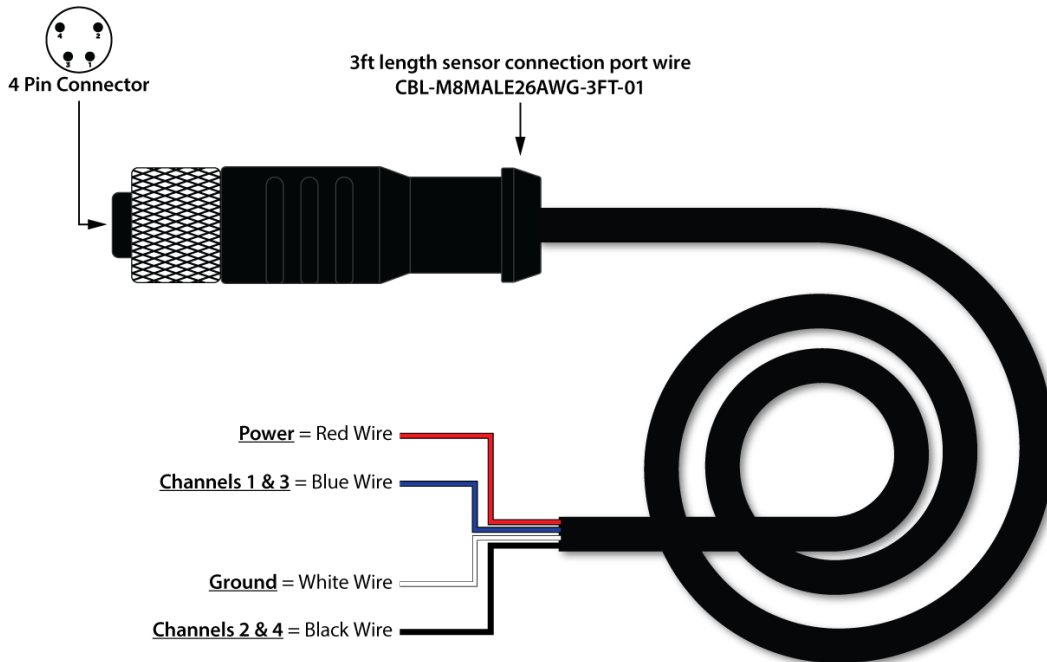

# WBP\_SC\_0005\_02

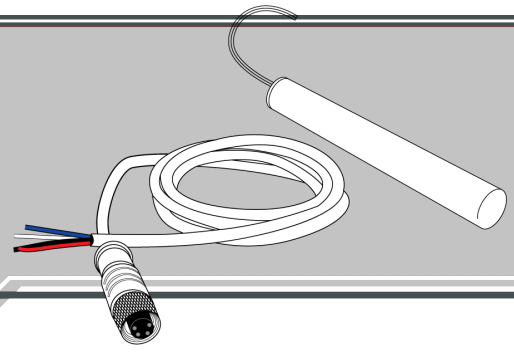

## Sensor Cable / Thermistor



### General Description

This cable kit contains a base Sensor Attachment Cable that is connected to the sensor block. The below listed components are shipped attach to the listed Sensor Attachment Cable as shown in the below diagram.

This bundle contains the following components:

Quantity	Part Number	Description	
1	WBP-TR-01-3F	8cm Thermistor Temperature Probe, 91cm Cable	
1	CBL_M8MALE26AWG_3FT_01	Sensor Attachment Cable, 91cm Cable Blue/No Marker = Channel 1, Yellow Marker = Channel 2	

### Wiring Diagram

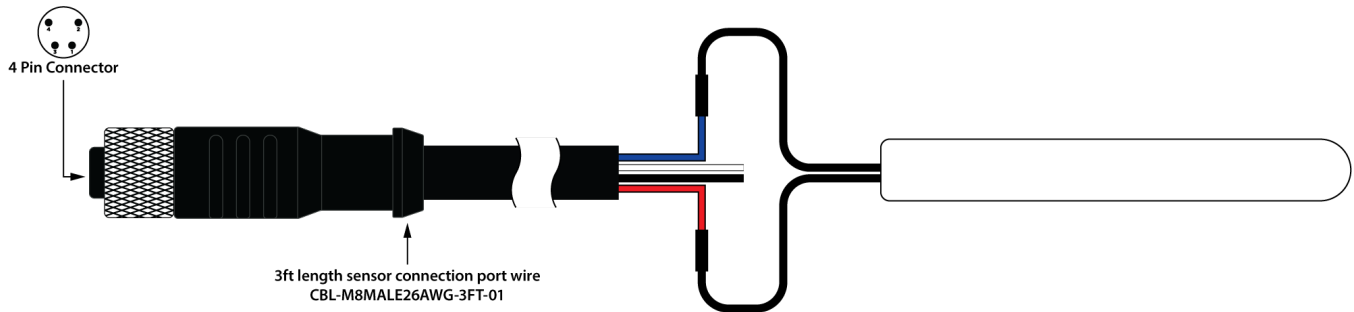

# WBP\_SC\_0005\_03

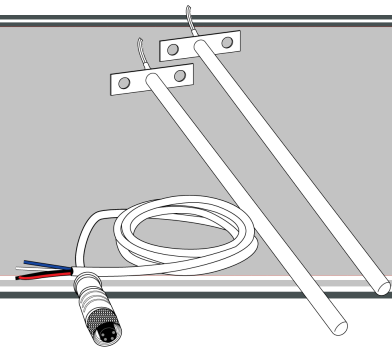

## Sensor Cable / 2 Duct Mount Thermistors



### General Description

This cable kit contains a base Sensor Attachment Cable that is connected to the sensor block. The below listed components are shipped attach to the listed Sensor Attachment Cable as shown in the below diagram.

This bundle contains the following components:

Quantity	Part Number	Description	
1	WBP-TR-03-3F	Thermistor Temperature Probe, Duct Mount, 91cm Cable	
1	CBL_M8MALE26AWG_3FT_01	Sensor Attachment Cable, 91cm Cable Blue/No Marker = Channel 1, Yellow Marker = Channel 2	

### Wiring Diagram

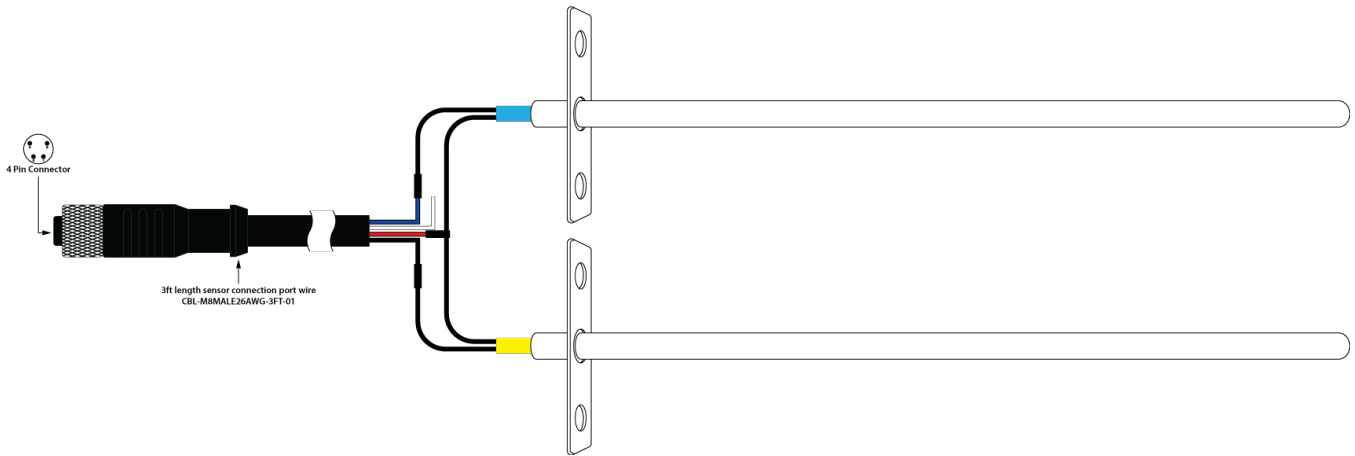

# WBP-TR-03-3F

Thermistor Temperature Probe, Duct Mount, 91cm Cable

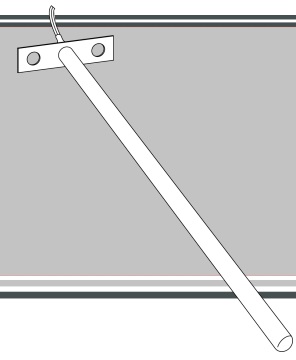

## General Description

Whisker.Blocks® are long-range, wireless sensors that come in a variety of I/O and power configurations. These sensor blocks use our proprietary long range wireless communication technology, ensuring reliable and robust operation. They come in a variety of configurations with multiple external channels for various analog and digital inputs.

This external sensor is designed to work with a Whisker.Block® that is configured with an external thermistor (TR) input. When properly mounted, this sensor can detect temperatures in the range of -40°C to +85°C.

The thermistor is contained within a 8cm stainless steel housing that can be used in air, food products, and most liquids. It is available with a 15cm and 91cm cable.

We offer other temperatures probe configurations that can be used in a variety of applications. The WBP-TR-02-xx is a 13cm version of this probe, the WBP-TR-03-xx is designed to be mounted in HVAC ducts, and finally the WBP-TR-04-xx is a lug mounted probe that can be used on equipment such as motors.

## Power

Power for the sensor is provided by the Whisker.Block®.

## Mounting

The sensor is housed in a 20cm long tube with a top mounted flange. The flange has two 6.4mm holes for mounting to the duct. It should be mounted so that the sensor is fully inserted into the duct and is oriented so that the air will flow over the sensor as it passes through the duct.

Take care not to crimp or otherwise damage the sensor as that might adversely affect proper operation or might shorten the operating life of the sensor.

## Compatible Whisker.Blocks®

Part Number
WB1-9-00-DCTRNNNN-0000-LR
WB1-9-00-DCTRTRNN-0000-LR
WB1-9-00-C1TRTRNN-0000-LR
WB1-9-00-C2TRTRNN-0000-LR
WB1-9-00-C3TRTRNN-0000-LR
WB1-9-00-C4TRTRNN-0000-LR

## Wiring

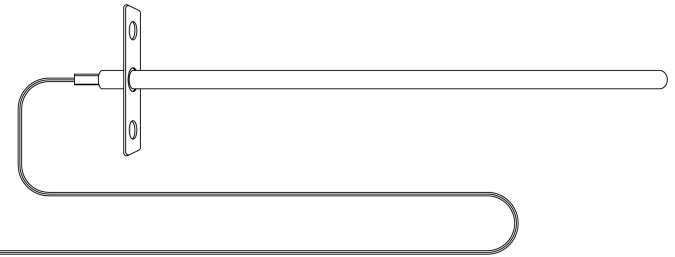

### Recommended Wiring:

Connector	Pin	Sensor Wire	Description
1	1	Red	Sensor power supply
1	2 or 3	Blue/Black	Thermister output

