



Yardian Pro
Smart Sprinkler Controller



Apple HomeKit



User Guide **VERSION 1.0**
PRO19 Series

Table of Contents

What's in the Box	4
Overview	5
Select Button and Run/Stop Button	6
Reboot Button and Wi-Fi Reset Button	7
Main LED Indicator	8
Understand Your Irrigation System	9
The Yardian Installation	11
• Step 1 Replace your old controller	12
• Step 2 Install your Yardian controller	14
• Step 3 Download the Yardian app	18
• Step 4 Pair your Yardian to your profile	20

• Step 5 Set up the Internet connection	21
◦ 5-A Ethernet connection	22
◦ 5-B Wi-Fi onboarding	24
▸ For Android users	27
▸ For iOS users	31
Setup of the Yardian App	37
• Home	38
• Control	40
• Yard	42
• Program	44
How to Use Apple Home App to Control Yardian	46

What's in the Box

1. Yardian Pro, the controller

Yardian must be connected to the power adapter included.

Output	24VAC, Max. 1A
Operating Temperature	-22°F to 140°F (-30°C to 60°C)

2. Power adapter

Input	100 – 240VAC, 50 – 60Hz
Output	36VDC, 1.66A

3. Power cord

4. Labeling stickers

5. Wall screws and anchors

Screw	Ø3/16 x 1"
-------	------------

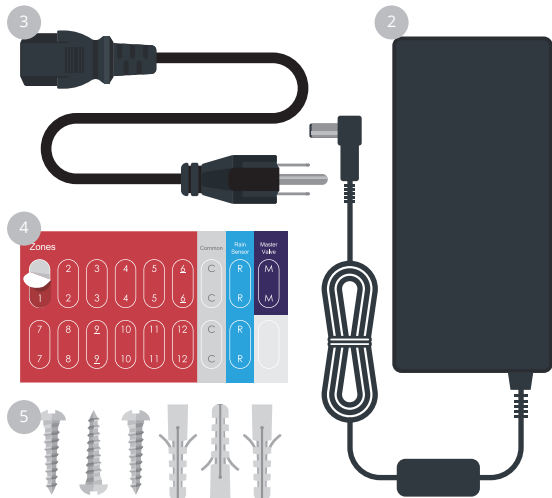

Overview

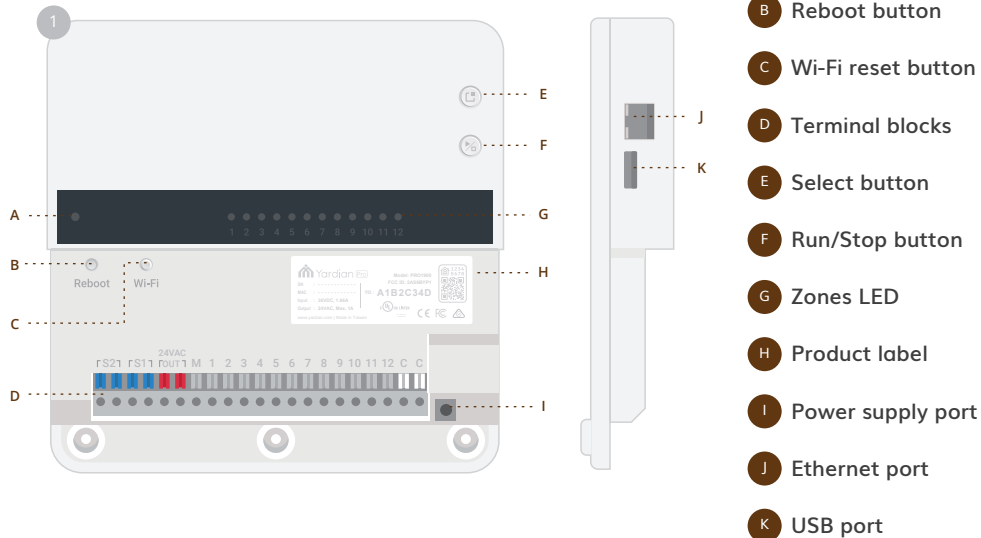



Select Button and Run/Stop Button

 Select button



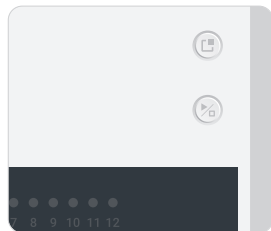

 Run/Stop button

Auto Scan

- Press/hold  **Select** and  **Run/Stop** at the same time
 - LED in **green**: solenoid valve attached
 - LED in **red**: faulty solenoid valve detected (over current)



Instant Control

- Click  **Select** on the top to specify a zone in **Zone Selection Mode** (LED in **green**).
- Press/hold  **Select** for over 1 second to switch between **Zone Selection Mode** and **Time Selection Mode** (LED in **red**).
- Click  **Select** to specify duration in min(s) in **Time Selection Mode**.
- Click  **Run/Stop** to run the zone. To stop watering anytime, press/hold  **Run/Stop** for over 3 seconds.

Reboot Button and Wi-Fi Reset Button

Reboot Button

Press to reboot the system

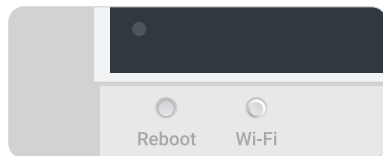

Wi-Fi Reset Button

Reset Wi-Fi

Press and hold for around 5 seconds, release when the LED is blinking green and blue.



Reset to factory default

Press and hold for around 10 seconds, release when the LED turns red.

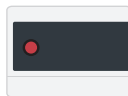

Main LED Indicator

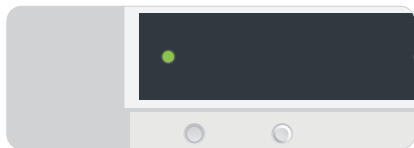

1 second 1 second

System

Booting Up



Initializing



Firmware Updating

(Do not turn off power)



Reboot Required

(Press the Reboot Button)



Reboot Required - Action Failed

(Press the Reboot Button)



Wi-Fi Station Mode

Connecting to Your Router



Connected to the Internet



Watering



Wi-Fi AP Mode

Access Point Mode



Watering



Ethernet

Connected to the Internet



Watering



Understand Your Irrigation System

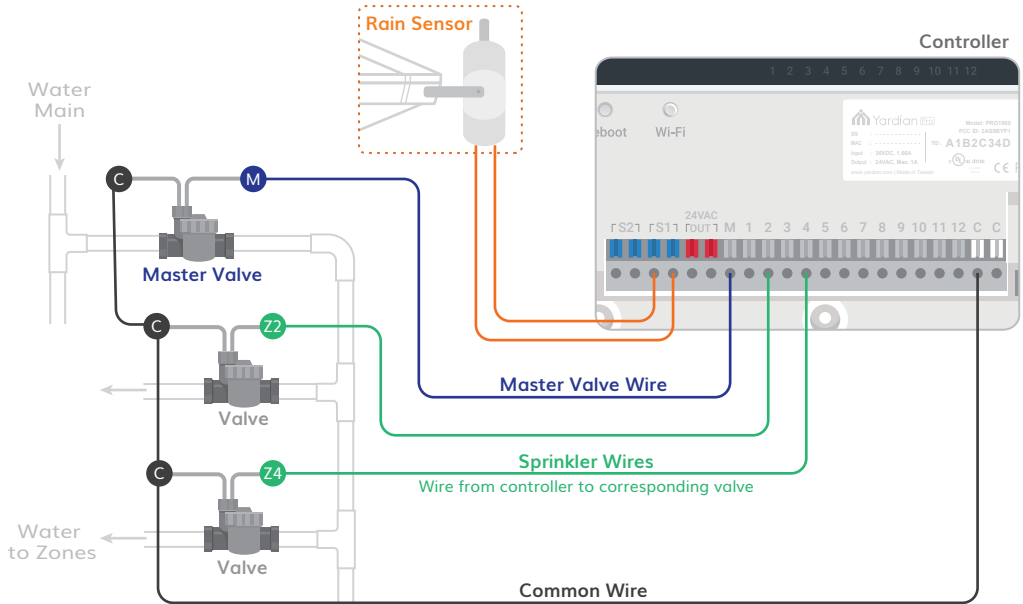



Digital version user guide

The Yardian Installation

Set up your Yardian in a few easy steps

The Yardian should be mounted less than 6.5 feet (2 meters) from the floor for easier accessibility.

Step

1

Replace your old controller

Take a picture of your current wiring. This will help you identify the correct sequence of wires.

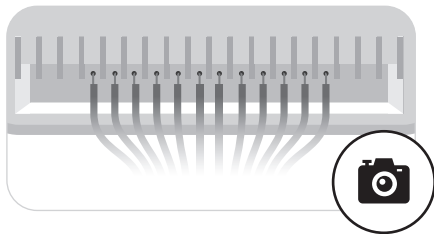

Exposed sprinkler wires with 24VAC could generate an electric shock in wet locations. Please ask your retailer or contractor if sprinkler accessories may be needed.



Disconnect your old controller and remove sprinkler wires. Adhere a numeric labeling sticker to tag each associated wire for easy identification.

Remove your old controller from the wall.

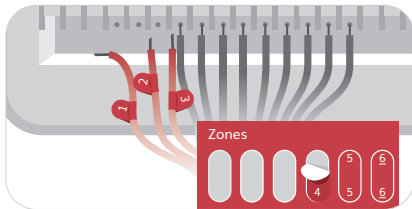

- Zones - wires connected to zone valves
- Common - common wire or ground wire
- Rain Sensor - optional
- Master Valve - optional

Step
2

Install your Yardian controller

Open the top cover.

Mount your Yardian to the desired location.



Place your thumb on the top right corner to make it easier to open the cover.

Mark the wall for the screws. Mount the Yardian with the screws.
Connect sprinkler wires according to the corresponding labels.

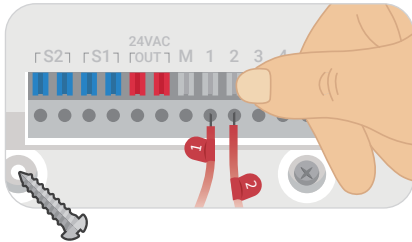

Please specify your rain sensor type (normally open or closed) in the app if applicable.

If you attach more than 1 solenoid to a zone, please check your solenoid specifications and make sure the overall current consumption does not exceed 0.9A.



Plug the power cord into the home outlet.

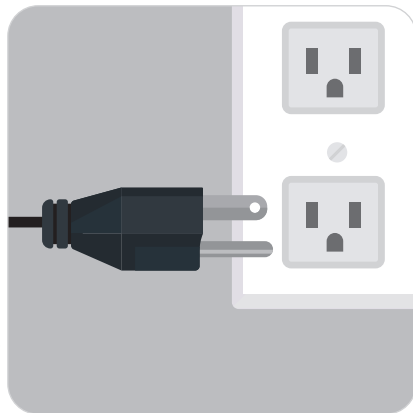
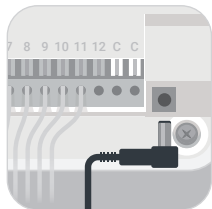
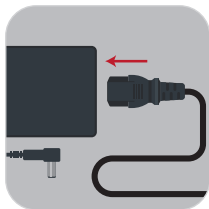

Ensure to connect the power cord to a socket-outlet with earthing connection.

Close the top cover.



! CAUTION

This product contains CR1225 battery. Risk of explosion if the battery is replaced by an incorrect type

Step
3

Download the Yardian app

Create an account.

Sign in the Yardian app with your account.



iOS 9.0+ and Android™ 5.0 Lollipop@+

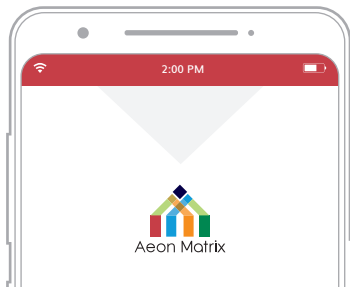

Enter your profile name and locate your Yardian.

Yardian location settings will help to get the weather information with accuracy.

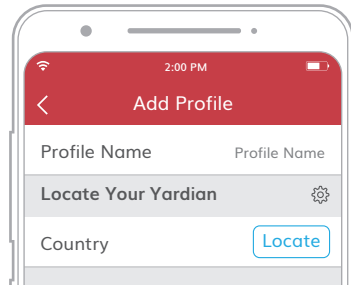

Step
4

Pair your Yardian to your profile

Select the Yardian device settings card to start pairing.

Enter the 8-digit Yardian ID (YID) on the device.

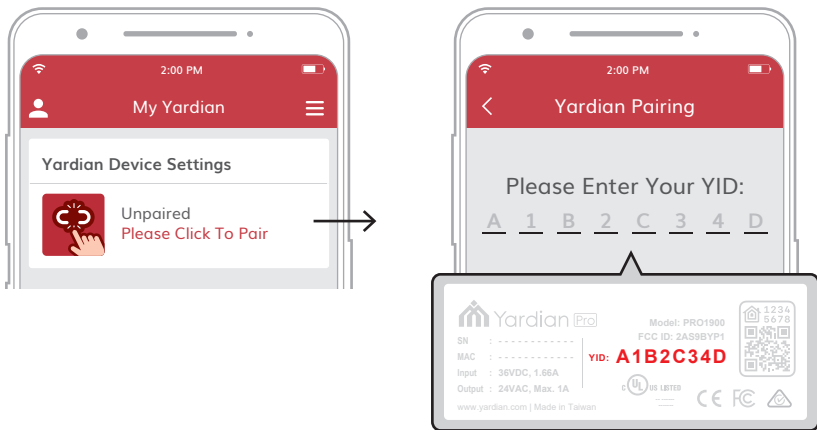

Step 5

Set up the Internet connection

Yardian is now paired to your profile. Next, set up the Internet connection for Yardian.

You can choose to use an Ethernet connection (see Step 5-A) or a Wi-Fi connection (see Step 5-B).

Step 5-A Ethernet connection p.22

Step 5-B Wi-Fi onboarding p.24

The Ethernet connection has a higher priority than the Wi-Fi connection when an Ethernet cable is detected to be connected.

Step 5-A

Ethernet connection

Connect the Ethernet cable to Yardian.

Connect the other end of the Ethernet cable to an open port on your router.

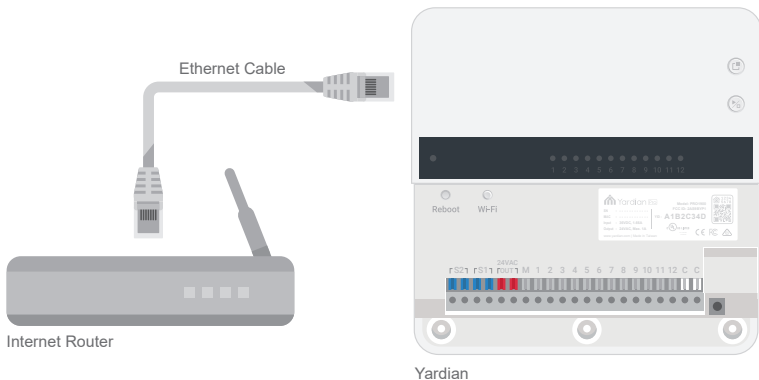



Check your Yardian LED: if it turns into solid blue, it means that Yardian has successfully connected to the Internet.

Congratulations! You have completed the setup process for your Yardian.

 **WARNING**

Software may be updated when Yardian is connected to the Internet. Please **DO NOT** turn off the power when the LED is blinking RED. Interrupting the software update process may result in system malfunction.



Step 5-B

Wi-Fi onboarding

Please stay close to the Yardian device when doing "Wi-Fi onboarding".

The Yardian app will automatically lead you to the "Wi-Fi onboarding" process. If it does not, please select the Yardian device settings card and go to "Wi-Fi onboarding".

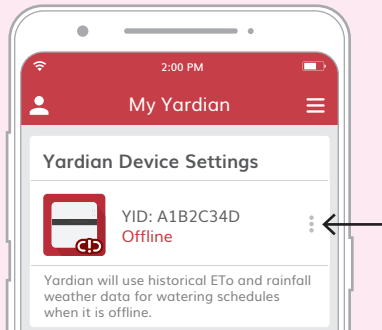

Check Yardian's LED status. Yardian should be in Wi-Fi AP mode to proceed (LED blinking green and blue).

If your Yardian is not blinking green and blue, please press and hold the Wi-Fi reset button for around 5 seconds until the LED blinks green and blue.

 **LED in purple!**

If your Yardian is in Wi-Fi AP mode for more than 15 minutes, you will be asked to reboot Yardian (Press the reboot button).

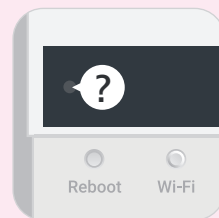

Wi-Fi connection process may vary depending on the operating system, please follow the instructions based on the operating system of your mobile device.

For Android users

p.27

For iOS users

p.31

For Android users

Please allow the Yardian app to access the device's location to get a list of available networks.

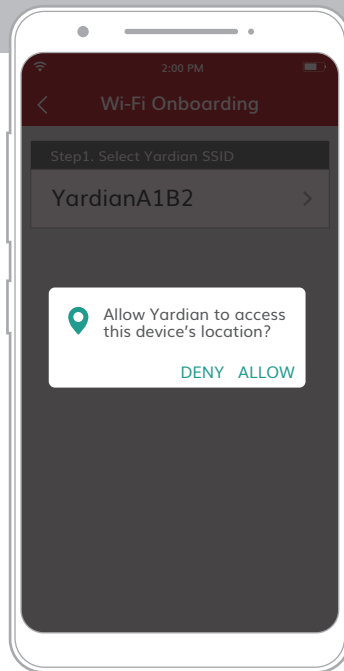

Select the Yardian SSID.

The Yardian app will scan for nearby wireless signals to provide you with a list of wireless networks to choose from.

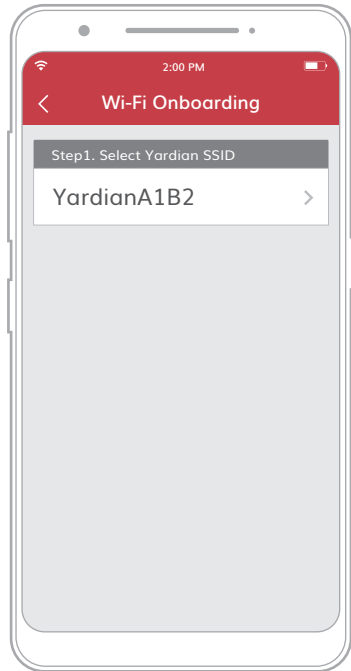

Specify your home Wi-Fi router SSID and password.

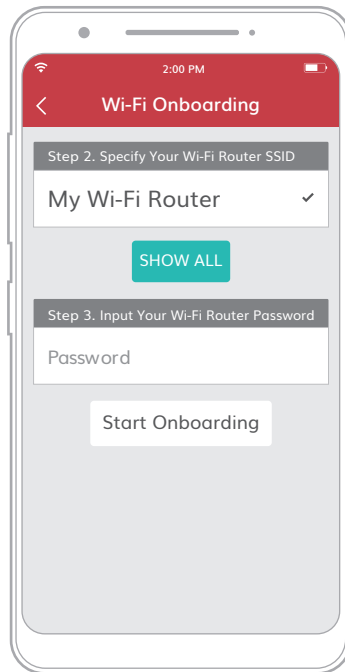



Check your Yardian LED: if it turns into solid green, it means that Yardian has successfully connected to the Internet.

Congratulations! You have completed the setup process for your Yardian.

 **WARNING**

Software may be updated when Yardian is connected to the Internet. Please **DO NOT** turn off the power when the LED is blinking RED. Interrupting the software update process may result in system malfunction.



For iOS users

This step will help to build your Yardian as an Apple Home accessory as well as connect to the Internet.

Please turn on Wi-Fi on your mobile device and make sure you have installed Apple's Home app.

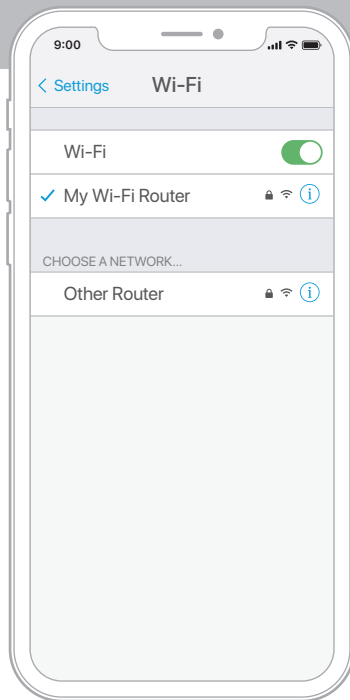

Go to the Home app for connecting Yardian to the Wi-Fi & HomeKit network.

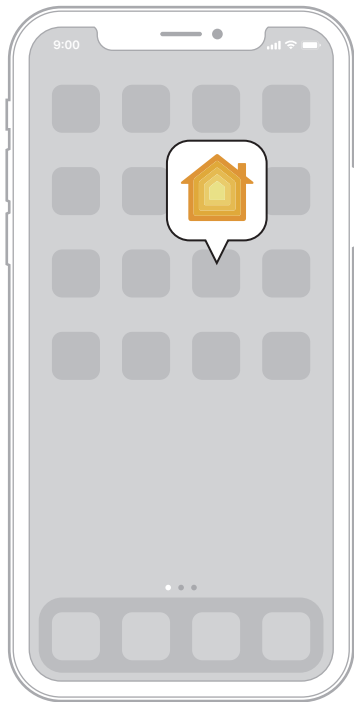

Tap "Add accessory" to start.
Use the HomeKit setup code on the
Yardian device.

Follow the instructions in Home app
to complete the configuration.

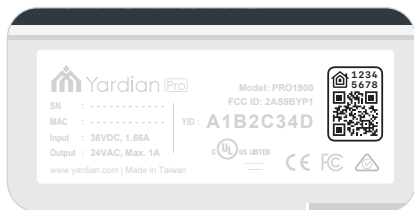

Go back to the Yardian app. Check the Yardian status: if it shows "Online", it means you have successfully connected your Yardian to the Internet.

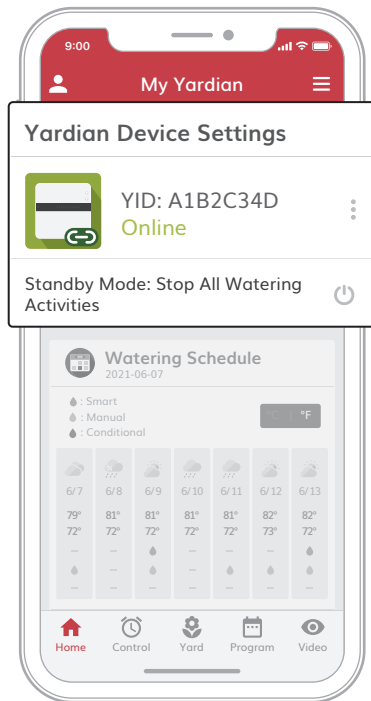



Congratulations! You have completed the setup process for your Yardian.

 **WARNING**

Software may be updated when Yardian is connected to the Internet. Please **DO NOT** turn off the power when the LED is blinking RED. Interrupting the software update process may result in system malfunction.





📹 Video feature is only available for selected models

Setup of the Yardian App

Easy access to the settings with 4 simple tabs



Home

You may review all information here

Receive the latest information regarding your watering schedule, Yardian notifications, and more.

My Yardian



Yardian Device Settings

 YID: A1B2C34D
Online





Standby Mode: Stop All Watering Activities 

Watering Schedule

2021-06-07



 : Smart
 : Manual
 : Conditional

Date	Temp	Humidity	Weather	Program
6/7	79°	72°	Cloudy	Manual
6/8	81°	72°	Cloudy with rain	Manual
6/9	81°	72°	Partly sunny	Smart
6/10	81°	72°	Cloudy with rain	Manual
6/11	81°	72°	Cloudy with rain	Manual
6/12	82°	73°	Partly sunny	Manual
6/13	82°	72°	Partly sunny	Smart

 Home
  Control
  Yard
  Program
  Video

Week Schedule

Mon	Tue	Wed	Thu	Fri	Sat	Sun
07	08	09	10	11	12	13

 6/13 Sunday  0%

[Show All Zones](#)

 MyZone 1 Zone 1

 Smart Program

 05:30 - 05:35

 MyZone 2 Zone 2

 Manual Program

 06:30 - 06:35



Control

You get to control all zones here

Control your zones to start watering at any desired time with just a touch of the button on your mobile device.

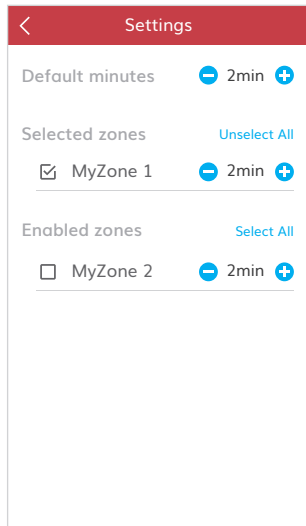
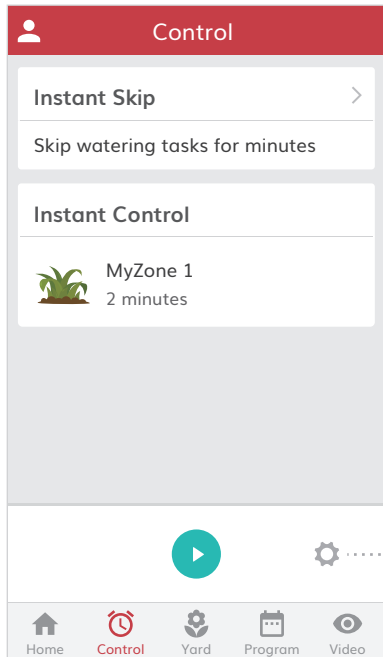



Yard

Profile your yard

You may set up and manage all your yard profile information here. Our app can automatically detect the connected zones and enable them.

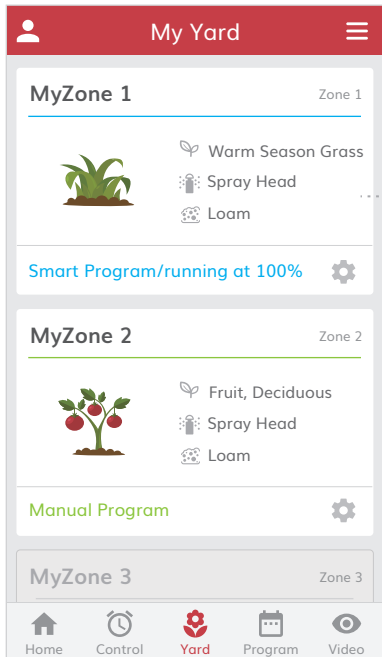

A Go to the "Yard" tab.

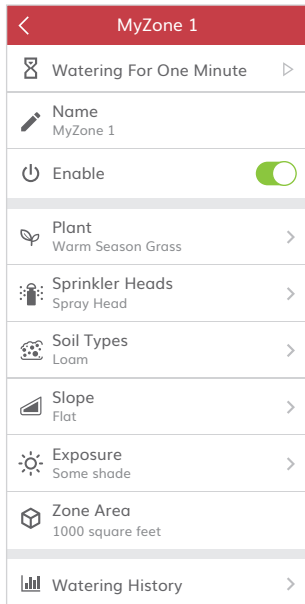

B Tell us about your garden.



Program

Program the watering schedule

Set up watering program(s) for each zone according to your needs.

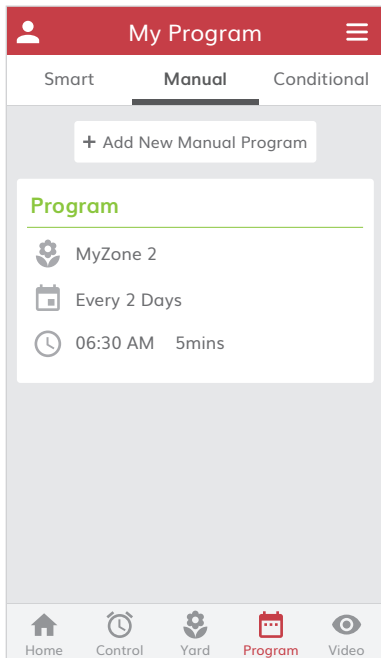

Smart Program designs automatic watering schedules based on your zone profiles, weather data, watering restrictions, and your preferences for each zone.

Manual Program allows you to create your own watering schedule. You have the choice to apply "Seasonal Adjustment" in your manual programs.

Conditional Program allows you to create a watering schedule with a trigger event, such as specific temperatures. It's a special program that you can use in addition to a Smart Program or Manual Program for your zone(s).



How to Use Apple Home App to Control Yardian

iOS users can also do Yardian basic controls from the Home app.

After you have done the settings in the Yardian app, go to the Home app and find Yardian, you can see switches for enabled zones.

To control this HomeKit-enabled accessory, iOS 9.0 or later is recommended.

Use of the Works with Apple HomeKit logo means that an electronic accessory has been designed to connect specifically to iPod touch, iPhone, or iPad, respectively, and has been certified by the developer to meet Apple performance standards. Apple is not responsible for the operation of this device or its compliance with safety and regulatory standards.

Drag the switch to run or stop watering the zone.

Tap the gear icon for zone setting. In each zone card, you can:

- Enable or disable zones;
- Name the zone;
- Set watering duration for each zone.

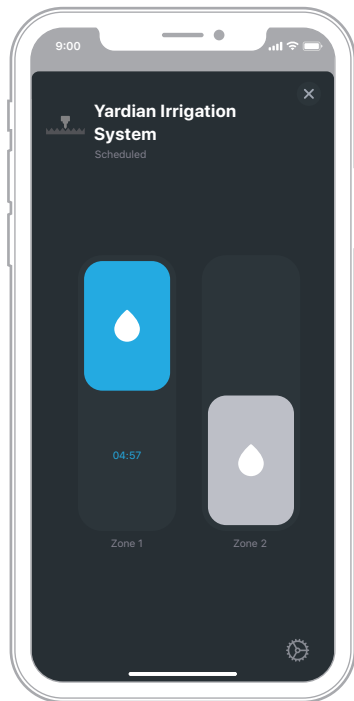



The Federal Communication Commission Interference Statement

This device complies with part 15 of the FCC Rules. Operation is subject to the following two conditions: (1) This device may not cause harmful interference, and (2) this device must accept any interference received, including interference that may cause undesired operation.

Any changes or modifications not expressly approved by the party responsible for compliance could void the user's authority to operate the equipment.

NOTE: This equipment has been tested and found to comply with the limits for a Class B digital device, pursuant to part 15 of the FCC Rules. These limits are designed to provide reasonable protection against harmful interference in a residential installation. This equipment generates, uses and can radiate radio frequency energy and, if not installed and used in accordance with the instructions, may cause harmful interference to radio communications. However, there is no guarantee that interference will not occur in a particular installation. If this equipment does cause harmful interference to radio or television reception, which can be determined by turning the equipment off and on, the user is encouraged to try to correct the interference by one or more of the following measures:

- Reorient or relocate the receiving antenna.
- Increase the separation between the equipment and receiver.
- Connect the equipment into an outlet on a circuit different from that to which the receiver is connected.
- Consult the dealer or an experienced radio/TV technician for help

The FCC RF Exposure Information

This Transmitter must not be co-located or operating in conjunction with any other antenna or transmitter. This equipment complies with FCC RF radiation exposure limits set forth for an uncontrolled environment. This equipment should be installed and operated with a minimum distance of 20 centimeters between the radiator and your body.

Yardian Smart Sprinkler Controller Limited Warranty

THIS LIMITED WARRANTY CONTAINS IMPORTANT INFORMATION ABOUT YOUR RIGHTS AND OBLIGATIONS, AS WELL AS LIMITATIONS AND EXCLUSIONS THAT MAY APPLY TO YOU.

WHAT THIS LIMITED WARRANTY COVERS; PERIOD OF COVERAGE

Aeon Matrix, Inc. may restrict this Limited Warranty service for the Product to the country where the Product or its authorized distributors originally sold the Product. Aeon Matrix, Inc. ("Aeon Matrix") warrants the enclosed product contained in this box ("Product") will be free from defects in materials and workmanship for a period of two (2) years from the date of delivery following the original retail purchase by the end-user purchaser (the "Warranty Period"). If the Product fails to conform to this Limited Warranty during the Warranty Period, Aeon Matrix will, at its sole discretion, either (a) repair or replace the defective Product or any component thereof; or (b) accept the return of the Product and refund the money actually paid by the original retail purchaser for the Product. Repair or replacement may be made with a new or refurbished Product or components thereof, at Aeon Matrix' sole discretion. If the Product or a component incorporated within it is no longer available, Aeon Matrix may replace the Product or component in question with a similar product or component of similar function, at Aeon Matrix' sole discretion. This is your sole and exclusive remedy for Product covered under the limited warranty within the Warranty Period. Any Product or component thereof that has been repaired or replaced under the Limited Warranty shall remain covered by the terms of this Limited Warranty for the longer of (a) ninety (90) days from the date of delivery of the repaired or replaced product, or (b) the remainder of the Warranty Period. This Limited Warranty is transferable from the original retail purchaser to subsequent owners or purchasers, but the Warranty Period will not be extended in duration or expanded in coverage for any such transfer.

TOTAL SATISFACTION RETURN POLICY

If you are the original retail purchaser of the Product and you are not satisfied with this Product for any reason, you may return it in its original condition within thirty (30) days of the original purchase and receive a full refund.

WARRANTY CONDITIONS; HOW TO GET SERVICE IF YOU WANT TO CLAIM UNDER THIS LIMITED WARRANTY

Before making a claim under this Limited Warranty, the owner of the Product must (a) notify Aeon Matrix of the intention to claim by visiting support.aeonmatrix.com during the Warranty Period and providing a reasonably adequate description of the alleged non-conformity of Product or its component(s), and (b) comply with Aeon Matrix's return shipping instructions. Aeon Matrix shall have no warranty obligations with respect to a returned Product or component(s) thereof if it determines, in its reasonable discretion after examination of the returned Product, that the Product is an Ineligible Product (defined below). Aeon Matrix will bear all costs of return shipping to the owner and will reimburse any shipping costs incurred by the owner, except with respect to any Ineligible Product, for which owner will bear all shipping costs.

WHAT THIS LIMITED WARRANTY DOES NOT COVER

This Limited Warranty does not cover the following (collectively "Ineligible Products"): Products or their components marked as "sample" or sold "AS IS"; or Products or their components that have been subject to: (a) unauthorized modifications or alterations, tampering, unauthorized or improper maintenance or repairs; (b) handling, storage, installation, testing or use not in accordance with the User's Guide or other instructions provided by Aeon Matrix; (c) abuse or misuse of the Product; (d) breakdowns, fluctuations, or interruptions in electric power or the telecommunications network; (e) Acts of God, including but not limited to lightning, flood, liquid contact, tornado, earthquake, hurricane, accident, or other external cause; (f) use with a third party component or product that does not meet the Products specifications; (g) cosmetic damage, including but not limited to scratches, dents and broken plastic on parts unless damage is due to defects in materials or workmanship of the Product; (h) defects caused by normal wear and tear or otherwise due to the normal aging of the Product; or (i) if any serial number has been removed or defaced from the Product. This Limited Warranty does not cover consumable parts, such as batteries or protective coatings that are designed to diminish over time, unless damage is due to defects in materials or workmanship of the Product (even if such consumable parts are packaged or sold with the product). Unauthorized use of the Product or software can impair the Product's performance and may invalidate this Limited Warranty. This Limited Warranty does not apply to any hardware products or any software not provided or authorized by Aeon Matrix, even if packaged or sold with Aeon Matrix Product or Aeon Matrix hardware. Software distributed by or not by Aeon Matrix is not covered by this Limited. Aeon Matrix does not warrant that the operation of the Product will be uninterrupted or error-free.

DISCLAIMER OF WARRANTIES

EXCEPT AS STATED ABOVE IN THIS LIMITED WARRANTY, AND TO THE MAXIMUM EXTENT PERMITTED BY APPLICABLE LAW, AEON MATRIX DISCLAIMS ALL EXPRESS, IMPLIED, AND STATUTORY WARRANTIES AND CONDITIONS WITH RESPECT TO THE PRODUCT AND ITS COMPONENTS, INCLUDING BUT NOT LIMITED TO THE IMPLIED WARRANTIES OF MERCHANTABILITY, NON-INFRINGEMENT OF INTELLECTUAL PROPERTY AND FITNESS FOR A PARTICULAR PURPOSE. TO THE MAXIMUM EXTENT PERMITTED BY APPLICABLE LAW, IN SO FAR AS SUCH WARRANTIES CANNOT BE DISCLAIMED, AEON MATRIX LIMITS THE DURATION AND REMEDIES OF SUCH WARRANTIES TO THE DURATION AND CONDITIONS OF THIS EXPRESS WARRANTY.

LIMITATION OF DAMAGES

IN ADDITION TO THE ABOVE WARRANTY DISCLAIMERS AND TO THE MAXIMUM EXTENT PERMITTED BY APPLICABLE LAW, IN NO EVENT SHALL AEON MATRIX BE LIABLE FOR ANY CONSEQUENTIAL, INCIDENTAL, EXEMPLARY, OR SPECIAL DAMAGES, INCLUDING ANY DAMAGES FOR LOST DATA OR INFORMATION OR LOST PROFITS ARISING FROM OR RELATING TO THIS LIMITED WARRANTY OR THE PRODUCT AND ITS COMPONENTS; AND AEON MATRIX'S TOTAL CUMULATIVE LIABILITY ARISING FROM OR RELATED TO THIS LIMITED WARRANTY OR THE PRODUCT AND ITS COMPONENTS SHALL NOT EXCEED THE AMOUNT ACTUALLY PAID FOR THE PRODUCT BY THE ORIGINAL RETAIL PURCHASER.

LIMITATION OF LIABILITY OF INFORMATION

THE AEON MATRIX ONLINE SERVICES (“SERVICES”) MAY PROVIDE YOU INFORMATION (“PRODUCT INFORMATION”) REGARDING YOUR PRODUCT OR OTHER PERIPHERALS CONNECTED TO YOUR PRODUCT (“PRODUCT PERIPHERALS”). THE TYPE OF PRODUCT PERIPHERALS THAT MAY BE CONNECTED TO YOUR PRODUCT MAY CHANGE FROM TIME TO TIME. WITHOUT LIMITING THE GENERALITY OF THE DISCLAIMERS ABOVE, ALL PRODUCT INFORMATION IS PROVIDED FOR YOUR CONVENIENCE “AS IS” AND “AS AVAILABLE”. AEON MATRIX DOES NOT REPRESENT, WARRANT, OR GUARANTEE THAT PRODUCT INFORMATION WILL BE AVAILABLE, ACCURATE, OR RELIABLE OR THAT PRODUCT INFORMATION OR USE OF THE SERVICES OR PRODUCT WILL EFFECT YOUR TOTAL WATER CONSUMPTION OR CONDITION OF YOUR PLANTS AND GARDEN. AEON NOR DOES AEON MATRIX REPRESENT, WARRANT, OR GUARANTEE THAT PRODUCT INFORMATION OR USE OF THE SERVICES OR PRODUCT WILL PROVIDE SAFETY IN YOUR HOME. YOU USE ALL PRODUCT INFORMATION, THE SERVICES, AND THE PRODUCT AT YOUR OWN DISCRETION AND RISK. YOU WILL BE SOLELY RESPONSIBLE FOR (AND AEON MATRIX DISCLAIMS) ANY AND ALL LOSS, LIABILITY, OR DAMAGES, INCLUDING BUT NOT LIMITED TO YOUR VALVES OF ANY KIND, PUMPS, PUMPS RELAYS, IRRIGATION EMITTERS OF ANY KIND, WIRING, FIXTURES, ELECTRICITY, HOME, PRODUCT, PRODUCT PERIPHERALS, COMPUTER, MOBILE DEVICE, AND ALL OTHER ITEMS AND PETS IN YOUR HOME, RESULTING FROM YOUR USE OF THE PRODUCT INFORMATION, SERVICES, OR PRODUCT. PRODUCT INFORMATION PROVIDED BY THE SERVICES IS NOT INTENDED AS A SUBSTITUTE FOR DIRECT MEANS OF OBTAINING THE INFORMATION.

VARIATIONS THAT MIGHT APPLY TO THIS LIMITED WARRANTY

This Limited Warranty gives you specific legal rights. You may also have other legal rights that vary by state, province, or jurisdiction. Likewise, some of the limitations set out above may not apply to you. The terms of this Limited Warranty will apply to the extent permitted by the applicable law.

GOVERNING LAW, JURISDICTION, AND DISPUTE RESOLUTION

This Limited Warranty and the purchase of the Product shall in all respects be construed, interpreted, and/or enforced in accordance with and governed by the laws of the State of California. Other than as set forth above, you knowingly and irrevocably waive the right to bring or maintain any action, claim or proceeding in any court of law arising out of or related to this Limited Warranty or the Product. You further irrevocably waive any right to a jury trial of any non-waived action, claim or proceeding.

www.yardian.com

✉ support@aeonmatrix.com



© 2020 Aeon Matrix Inc. All rights reserved.

Yardian is a registered trademark of Aeon Matrix Inc. Apple, APP Store and HomeKit are trademarks of Apple Inc., registered in the U.S. and other countries. Google, Android, and Google Play are trademarks of Google LLC. Any other product, brand and company names in this manual are the property of their respective owners.