

SERIES: VSK-S15-T | DESCRIPTION: AC-DC POWER SUPPLY
FEATURES

- up to 15W continuous power
- compact chassis mount design
- universal input (85~264 Vac / 100~370 Vdc)
- single output from 3.3~48 Vdc
- over voltage, over current, and short circuit protections
- UL/cUL safety approvals
- efficiency up to 85%

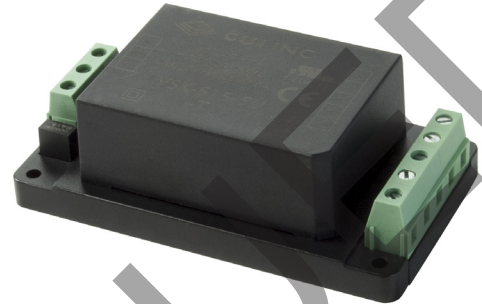

| MODEL | output voltage | output current max | output power max | ripple and noise ¹ | efficiency |
|----------------|----------------|--------------------|------------------|-------------------------------|------------|
| | (Vdc) | (A) | (W) | typ (mVp-p) | typ (%) |
| VSK-S15-3R3U-T | 3.3 | 3 | 9.9 | 50 | 73 |
| VSK-S15-5U-T* | 5 | 2.8 | 14 | 50 | 76 |
| VSK-S15-9U-T* | 9 | 1.6 | 14.4 | 50 | 78 |
| VSK-S15-12U-T* | 12 | 1.25 | 15 | 50 | 80 |
| VSK-S15-15U-T* | 15 | 1.0 | 15 | 50 | 80 |
| VSK-S15-24U-T* | 24 | 0.625 | 15 | 50 | 84 |
| VSK-S15-48U-T* | 48 | 0.32 | 15 | 50 | 85 |

Notes: 1. Ripple and noise are measured at 20 MHz BW by "parallel cable" method with 1 uF ceramic and 10 uF electrolytic capacitors on the output.
 *. Discontinued model

PART NUMBER KEY

INPUT

| parameter | conditions/description | min | typ | max | units |
|-----------------|---|-----|-----|-----|-------|
| voltage | | 85 | | 264 | Vac |
| | | 100 | | 370 | Vdc |
| frequency | | 47 | | 63 | Hz |
| current | at 115 Vac | | | 370 | mA |
| | at 230 Vac | | | 220 | mA |
| inrush current | at 115 Vac | | 10 | | A |
| | at 230 Vac | | 20 | | A |
| leakage current | at 230 Vac, 50 Hz (RMS) | | 0.1 | | mA |
| input fuse | 2 A/250 V, slow-blow type (included on chassis) | | | | |

OUTPUT

| parameter | conditions/description | min | typ | max | units |
|-------------------------|------------------------|-----|-------|--------|-------|
| capacitive load | 3.3 Vdc output model | | | 36,000 | μF |
| | 5 Vdc output model | | | 20,000 | μF |
| | 9 Vdc output model | | | 6,000 | μF |
| | 12 Vdc output model | | | 3,000 | μF |
| | 15 Vdc output model | | | 3,000 | μF |
| | 24 Vdc output model | | | 900 | μF |
| | 48 Vdc output model | | | 370 | μF |
| line regulation | at full load | | ±0.5 | | % |
| load regulation | at 10~100% load | | ±1 | | % |
| voltage set accuracy | | | ±2 | | % |
| hold-up time | at 115 Vac | | 15 | | ms |
| | at 230 Vac | | 80 | | ms |
| switching frequency | | | 65 | | kHz |
| temperature coefficient | | | ±0.02 | | %/°C |

PROTECTIONS

| parameter | conditions/description | min | typ | max | units |
|--------------------------|--------------------------|-----|-----|-----|-------|
| over current protection | auto restart | 110 | | | % |
| short circuit protection | continuous, auto restart | | | | |
| over voltage protection | 3.3 Vdc output model | | | 7.5 | Vdc |
| | 5 Vdc output model | | | 7.5 | Vdc |
| | 9 Vdc output model | | | 12 | Vdc |
| | 12 Vdc output model | | | 20 | Vdc |
| | 15 Vdc output model | | | 20 | Vdc |
| | 24 Vdc output model | | | 30 | Vdc |
| | 48 Vdc output model | | | 60 | Vdc |

SAFETY & COMPLIANCE

| parameter | conditions/description | min | typ | max | units |
|---------------------|--|-------|-----|-----|-------|
| isolation voltage | input to output for 1 minute | 3,000 | | | Vac |
| safety approvals | UL60950-1, CE | | | | |
| safety class | class II | | | | |
| conducted emissions | CISPR22/EN55022, Class B | | | | |
| radiated emissions | CISPR22/EN55022, Class B | | | | |
| ESD | IEC/EN61000-4-2 Class B, contact ±6 kV/air ±8 kV | | | | |
| radiated immunity | IEC/EN61000-4-3 Class A, 10V/m | | | | |
| EFT/burst | IEC/EN61000-4-4 Class B, ±2 kV | | | | |
| | IEC/EN61000-4-4 Class B, ±4 kV (external circuit required, see figure 2) | | | | |

SAFETY & COMPLIANCE (CONTINUED)

| parameter | conditions/description | min | typ | max | units |
|------------------------------|--|---------|-----|-----|-------|
| surge | IEC/EN61000-4-5 Class B, ± 1 kV/ ± 2 kV IEC/EN61000-4-5 Class B, ± 2 kV/ ± 4 kV (external circuit required, see figure 2) | | | | |
| conducted immunity | IEC/EN61000-4-6 Class A, 10 Vr.m.s | | | | |
| PFM | IEC/EN61000-4-8 Class A, 10 A/m | | | | |
| voltage dips & interruptions | IEC/EN61000-4-11 Class B, 0%-70% | | | | |
| MTBF | as per MIL-HDBK-217F at 25°C | 300,000 | | | hrs |
| RoHS | 2011/65/EU | | | | |

ENVIRONMENTAL

| parameter | conditions/description | min | typ | max | units |
|-----------------------|------------------------|-----|-----|-----|-------|
| operating temperature | see derating curves | -40 | | 70 | °C |
| storage temperature | | -40 | | 105 | °C |
| storage humidity | non-condensing | | | 95 | % |

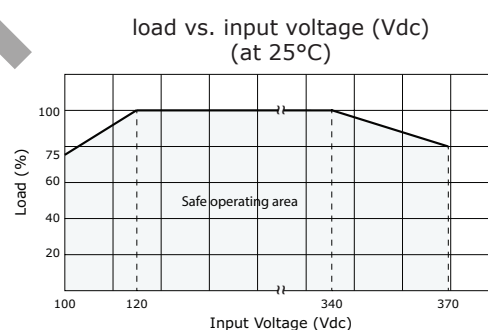
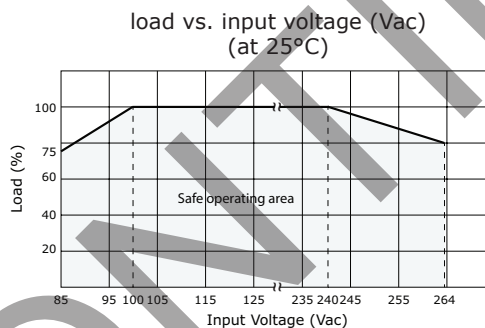
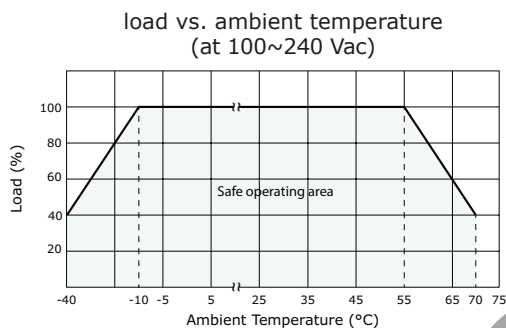
DERATING CURVES

MECHANICAL

| parameter | conditions/description | min | typ | max | units |
|---------------|---|-----|-----|-----|-------|
| dimensions | 96.10 x 54.00 x 31.00 (3.783 x 2.126 x 1.22 inch) | | | | mm |
| case material | UL94V-0 | | | | |
| weight | | | 135 | | g |
| cooling | convection cooling | | | | |

MECHANICAL DRAWING

units: mm[inches]

tolerance: $\pm 0.50[\pm 0.020]$

wire range: 24~12 AWG

| PIN CONNECTIONS | |
|-----------------|----------|
| PIN | FUNCTION |
| 1 | NC |
| 2 | AC(N) |
| 3 | AC(L) |
| 4 | -Vo |
| 5 | NC |
| 6 | NC |
| 7 | NC |
| 8 | +Vo |

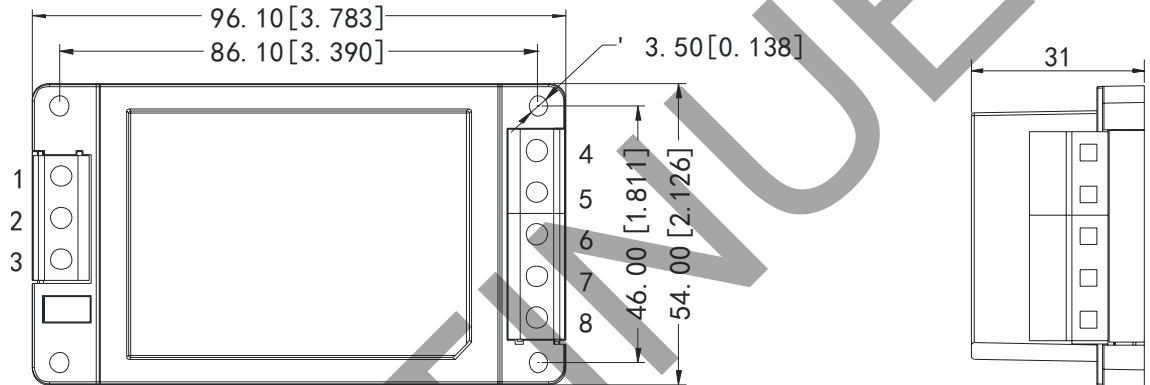

Top View

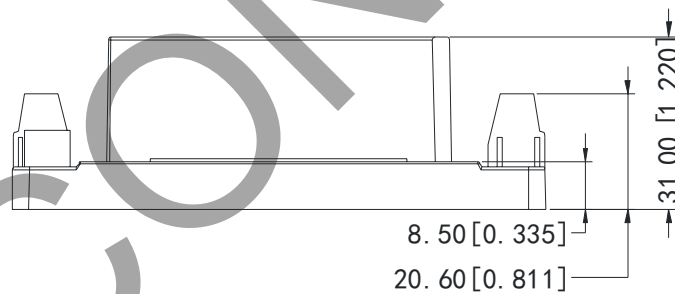

Side View

TYPICAL APPLICATION CIRCUIT

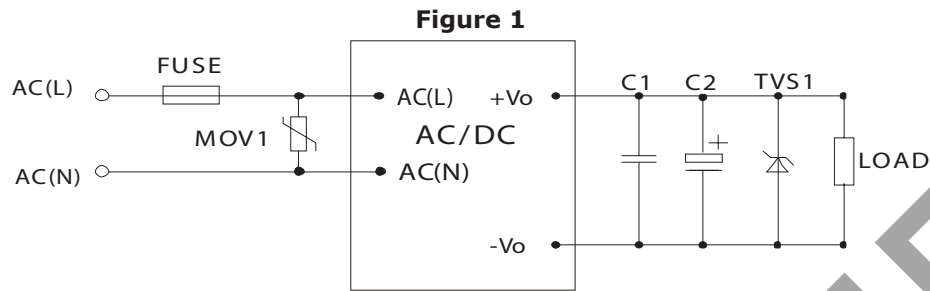

Table 1

| Recommended External Circuit Components | | | | | |
|---|-------------------|---------|-----------|-------------|----------|
| MODEL | FUSE ¹ | MOV1 | C1 | C2 | TVS |
| VSK-S15-3R3U-T | 2A/250V | S14K350 | 1 μ F | 680 μ F | SMBJ7.0A |
| VSK-S15-5U-T | 2A/250V | S14K350 | 1 μ F | 680 μ F | SMBJ7.0A |
| VSK-S15-9U-T | 2A/250V | S14K350 | 1 μ F | 470 μ F | SMBJ12A |
| VSK-S15-12U-T | 2A/250V | S14K350 | 1 μ F | 220 μ F | SMBJ20A |
| VSK-S15-15U-T | 2A/250V | S14K350 | 1 μ F | 220 μ F | SMBJ20A |
| VSK-S15-24U-T | 2A/250V | S14K350 | 1 μ F | 68 μ F | SMBJ30A |
| VSK-S15-48U-T | 2A/250V | S14K350 | 1 μ F | 33 μ F | SMBJ64A |

Note: 1. Fuse included on chassis

EMC RECOMMENDED CIRCUIT

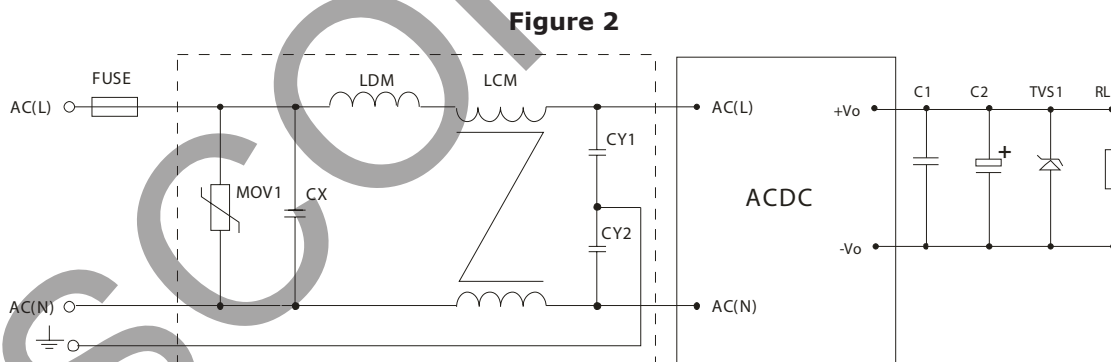

Table 2

| Recommended External Circuit Components | |
|---|--------------------|
| MOV1 | S14K350 |
| CY1, CY2 | 1000pF/400Vac |
| CX | 0.1 μ F/275Vac |
| LCM | 10mH |
| LDM | 4.7 μ H/2A |

Note: Also refer to Table 1

Notes: 1. Output filtering capacitor C2 is an electrolytic capacitor, It is recommended to use high frequency and low impedance electrolytic capacitors. For capacitance and current of capacitor please refer to manufacture's datasheet. Voltage derating of capacitor should be 80% or above. C1 is used to filter high frequency noise. TVS is recommended component to protect post-circuits (when converter fails).
2. All specifications measured at Ta=25C, humidity <75%, nominal input voltage, and rated output load, unless otherwise specified.

REVISION HISTORY

| rev. | description | date |
|------|--|------------|
| 1.0 | initial release | 09/06/2012 |
| 1.01 | corrected pinout | 10/21/2013 |
| 1.02 | updated spec | 08/20/2014 |
| 1.03 | updated operating and storage temperatures | 06/10/2015 |
| 1.04 | company logo updated | 10/29/2020 |
| 1.05 | discontinued model VSK-S15-15U-T, VSK-S15-24U-T, VSK-S15-48U-T, VSK-S15-5U-T, VSK-S15-9U-T | 11/11/2022 |

The revision history provided is for informational purposes only and is believed to be accurate.



CUI INC

a bel group

Headquarters

20050 SW 112th Ave.
Tualatin, OR 97062
800.275.4899

Fax 503.612.2383
cui.com
techsupport@cui.com

CUI offers a two (2) year limited warranty. Complete warranty information is listed on our website.

CUI reserves the right to make changes to the product at any time without notice. Information provided by CUI is believed to be accurate and reliable. However, no responsibility is assumed by CUI for its use, nor for any infringements of patents or other rights of third parties which may result from its use.

CUI products are not authorized or warranted for use as critical components in equipment that requires an extremely high level of reliability. A critical component is any component of a life support device or system whose failure to perform can be reasonably expected to cause the failure of the life support device or system, or to affect its safety or effectiveness.