



Thin-Film Directional Coupler

For 2400-2500MHz / 4900-5850MHz

TFSC06054125-2113A1X

0.65x0.5mm [EIA 0202]*

* Dimensions Code JIS[EIA]

Thin-Film Directional Coupler

Conformity to RoHS Directive

For 2400-2500MHz / 4900-5850MHz

TFSC06054125-2113A1X

SHAPES AND DIMENSIONS

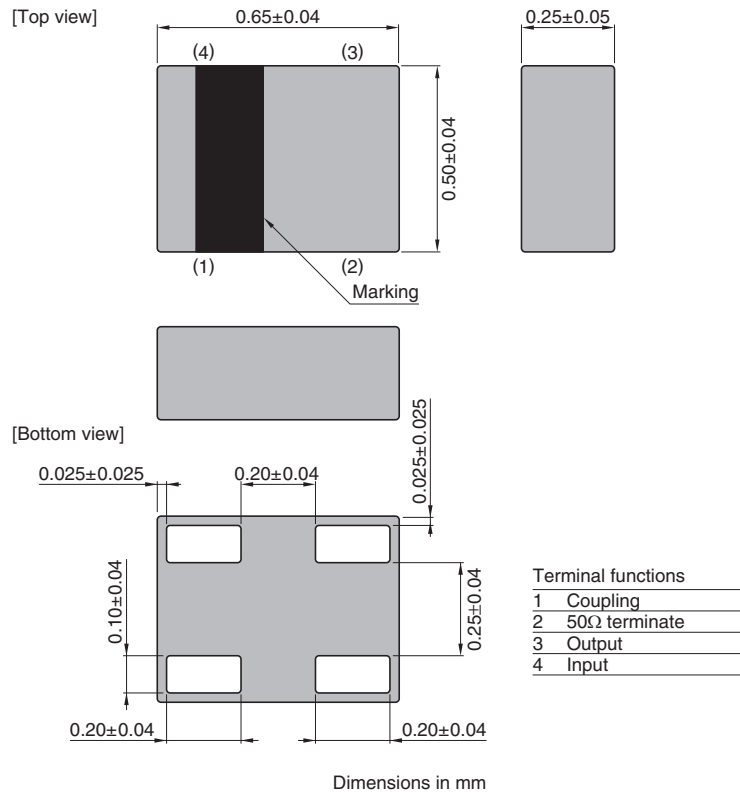

RECOMMENDED LAND PATTERN

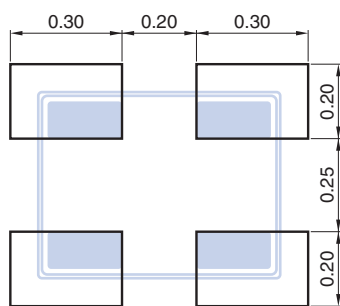

Line width be designed to match 50Ω characteristic impedance depending on PCB material and thickness.

○ RoHS Directive Compliant Product: See the following for more details. <https://product.tdk.com/info/en/environment/rohs/index.html>

- All specifications are subject to change without notice.
- Before using these products, be sure to request the delivery specifications.

TFSC06054125-2113A1X

ELECTRICAL CHARACTERISTICS

Item	Frequency Range (MHz)	Min.	Typ.	Max.
Coupling Factor (dB)	2400 to 2500	17.5	19.0	20.5
	4900 to 5850	11.0	12.5	14.0
Insertion Loss (dB)	2400 to 2500	—	0.11	0.25
	4900 to 5850	—	0.41	0.50
Return Loss (dB)	2400 to 2500	17.69	27.3	—
	4900 to 5850	17.69	20.8	—
Directivity (dB)	2400 to 2500	15	21.5	—
	4900 to 5850	15	21.3	—
Characteristic Impedance (Ω)			50 (Nominal)	

· Ta: +25°C

TEMPERATURE RANGE

Operating temperature (°C)	Storage temperature (°C)
-40 to +85	-40 to +85

MSL

Moisture Sensitivity Level (MSL)
1

TFSC06054125-2113A1X

FREQUENCY CHARACTERISTICS

INSERTION LOSS

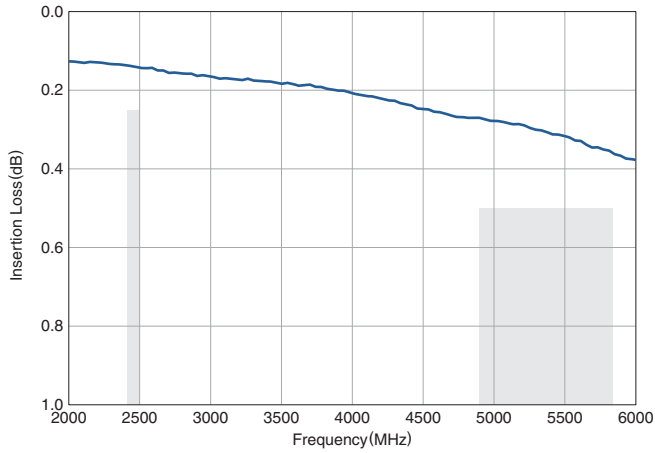

COUPLING

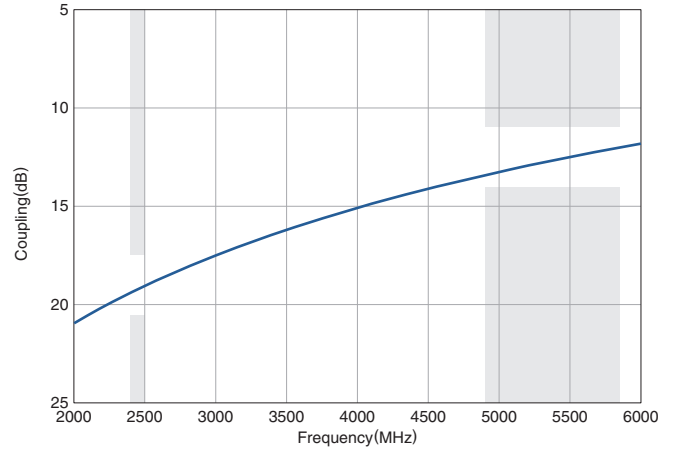

RETURN LOSS

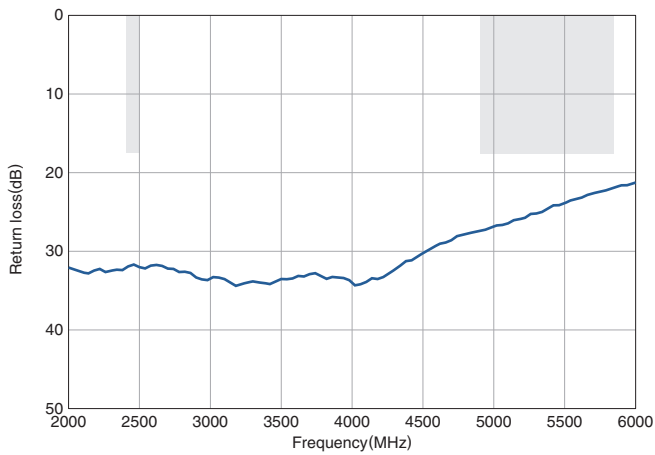

ISOLATION

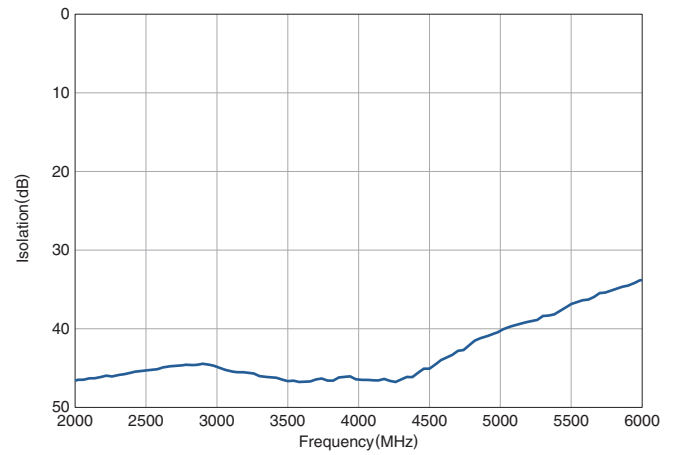

DIRECTIVITY

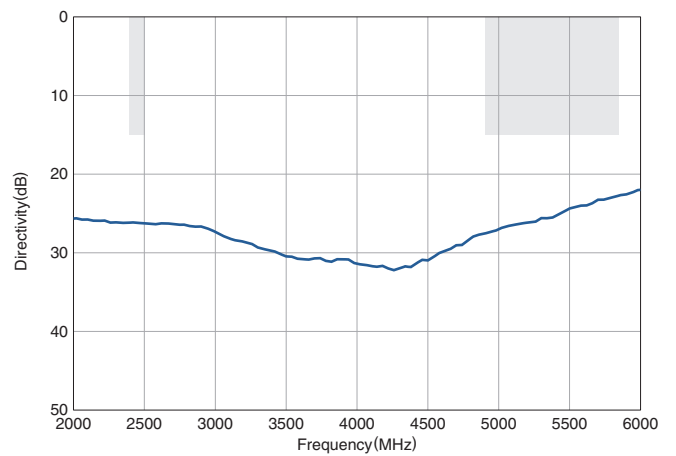

- All specifications are subject to change without notice.
- Before using these products, be sure to request the delivery specifications.

TFSC06054125-2113A1X

PACKAGING STYLE

REEL DIMENSIONS

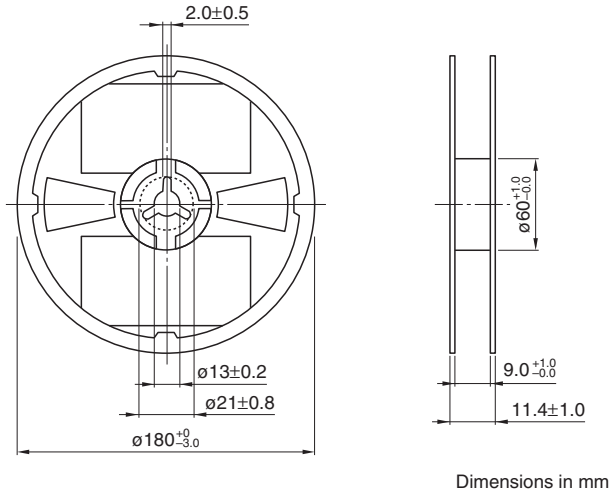

TAPE DIMENSIONS

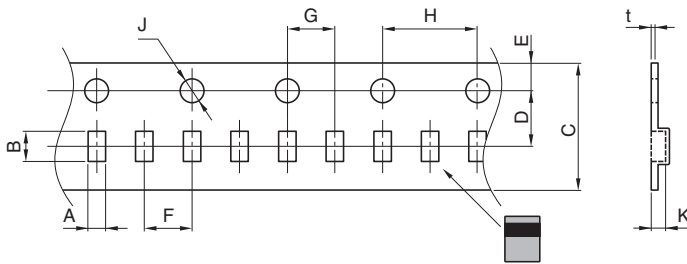

Dimensions in mm

A	B	C	D	E	F	G	H	J	K	t
0.63 ± 0.03	0.81 ± 0.03	8.0 ± 0.2	3.5 ± 0.05	1.75 ± 0.1	2.0 ± 0.05	2.0 ± 0.05	4.0 ± 0.1	$1.5 + 0.1 / - 0$	0.34 ± 0.03	0.20 ± 0.05

PACKAGE QUANTITY

Standard package quantity
(pieces/reel)

10,000

- All specifications are subject to change without notice.
- Before using these products, be sure to request the delivery specifications.

TFSC06054125-2113A1X

RECOMMENDED REFLOW PROFILE

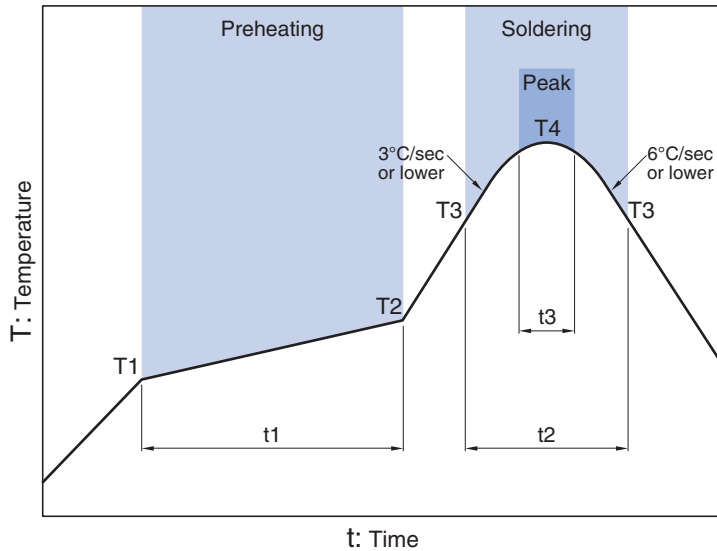

Preheating			Soldering			
Temp.	Temp.	Time	Critical zone (T3 to T4)		Temp.	Time
T1	T2	t1	T3	t2	T4	t3*
150°C	200°C	60 to 120sec	217°C	60 to 120sec	240 to 260°C	30sec max.

* t3 : Time within 5°C of actual peak temperature
The maximum number of reflow is 3.

使用注意事项

在使用本产品前，请务必随附采购规格书。

安全注意事项

使用本产品时，请注意安全事项。

注意

本产品目录中记载的产品是指在通用标准用途意义上使用于一般电子设备（AV 设备，通信设备，家电产品，娱乐设备，计算机设备，个人设备，办公设备，计测设备，工业机器人），并且该一般电子设备要在通常的操作和使用方法下使用。

对于需要高度安全性和可靠性的，或者设备的故障，误动作，运转不良可能会给人的生命，身体及财产等造成损害，以及有可能产生莫大社会影响的以下用途（以下称‘特定用途’）中的适用性，性能发挥，品质，本公司不予保证。

产品被在本产品目录的范围、条件之外，或者在特定用途中使用，本公司对它造成的损害和信赖性不承担任何责任。

- | | |
|-------------------------|--------------------|
| (1) 航天航空设备 | (8) 公共信息处理设备 |
| (2) 交通运输设备（汽车，电动火车，船舶等） | (9) 军事设备 |
| (3) 医疗设备 | (10) 电加热设备、燃烧设备 |
| (4) 发电控制设备 | (11) 防灾 / 预防犯罪设备 |
| (5) 原子能源相关设备 | (12) 安全设备 |
| (6) 海底设备 | (13) 其他不被视为常规用途的用途 |
| (7) 交通控制设备 | |

为了能够更安全地使用产品，对使用本产品目录中所记载产品的设备进行设计时，请确保符合该设备的使用用途及状态的保护回路和装置，并设置备用回路等。