

# FOC-FDX20-PP-STD6-OSP-PT9 - Splice box



1019682

<https://www.phoenixcontact.com/us/products/1019682>

Please be informed that the data shown in this PDF document is generated from our online catalog. Please find the complete data in the user documentation. Our general terms of use for downloads are valid.



Splice box, design: Rail-mountable module, degree of protection: IP20, material: Metal, connection method: Splicing, cable outlet: above and below, housing size: 1, color: gray, Ethernet

## Product description

FDX 20 series DIN rail splice box, equipped with 6x ST duplex couplings, fully assembled and ready for splicing with pre-assembled 900 µm pigtailed (OS2) and splice holder (for separately sold shrink and crimp splice protection) on a patented splice comb made from powder-coated sheet steel. Cable insertion possible via cable gland either at the top or bottom. Housing (2-part) prepared for DIN rail mounting through rear-side adapter (this can also be mounted on the side).

### Scope of supply:

DIN rail housing with integrated splice comb (mounted), equipped with 6x ST duplex couplings, 12x pigtailed (OS2), 1x splice holder, 1x cable gland (M20x1.5)

## Your advantages

- Intuitive front-panel operation and clear control cabinet layout thanks to uniform design
- Flexible DIN rail mounting possible in six positioning directions
- Suitable for industrial applications
- Reduced installation time with plug-and-play
- Pin assignment straight in line in a link
- Continuously reliable data connection, thanks to extensively tested components
- Snap-on mounting on standard NS 35/7,5 or NS 35/15 DIN rails
- Transmission rate up to 1,000 Mbps

## Commercial data

Item number	1019682
Packing unit	1 pc
Minimum order quantity	1 pc
Sales key	AB15
Product key	ABNGAA
Catalog page	Page 381 (C-2-2019)
GTIN	4055626701158
Weight per piece (including packing)	820.5 g
Weight per piece (excluding packing)	820 g
Customs tariff number	85367000
Country of origin	DE

# FOC-FDX20-PP-STD6-OSP-PT9 - Splice box



1019682

<https://www.phoenixcontact.com/us/products/1019682>

## Technical data

### Notes

General	In addition, shrink splice protection (Item No.: 1019676) or crimp splice protection (Item No.: 1019678) must be ordered separately.
---------	--

### Product properties

Type	Rail-mountable module
Product type	Network distributor box
Sensor type	Ethernet
Connection profile	ST-Duplex
No. of cable outlets	2
No. of conductors	12
Number of module slots	6
Number of slots	12
Type of the screw connection	M20 x 1.5
Housing type	DIN rail adapter
Protective cover	yes
Series	FDX 20 series
Cable outlet	above and below

### Electrical properties

Attenuation	≤ 0.3 dB
Transmission medium	FO

### Connection data

#### Connection technology

Connection method	Splicing
-------------------	----------

### Dimensions

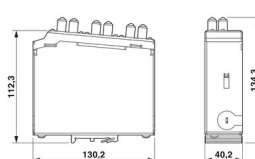
Dimensional drawing	
Width	40 mm
Height	130 mm
Depth	115 mm

#### Housing

Housing width	40 mm
---------------	-------

#### Mechanical characteristics

# FOC-FDX20-PP-STD6-OSP-PT9 - Splice box



1019682

<https://www.phoenixcontact.com/us/products/1019682>

Ferrule diameter	2.50 mm
------------------	---------

## Material specifications

Color	gray
Flammability rating according to UL 94	V0
Ferrule material	Zirconia ceramics
Housing surface material	Powder-coated, gray
Housing material	Metal

## Cable/line

Cable type	Single-mode fiberglass
Cable type	900 µm
Cable structure	semi-loose compact wires (STB)
External cable diameter ( )	6 mm ... 12 mm
External cable diameter	≤ 12 mm (of 6 mm) 6 mm ... 12 mm
Wire diameter incl. insulation	900 µm
Individual wire diameter	900 µm (250/900 µm)
Single wire, color	Assignment color-coded in accordance with IEC 60794-2
Halogen-free	yes
Flame resistance	yes

## FO cable

Number of fibers	12
Fiber	GOF
Fiber type	Single-mode fiberglass, resistant to bending G.657 A2
Attenuation	≤ 0.3 dB (at 1310 nm / 1550 nm)
Return Loss	≥ 50 dB (at 1310 nm / 1550 nm)
Transmission medium	FO

## Mechanical properties

### Mechanical data

Type of the screw connection	M20 x 1.5
Insertion/withdrawal cycles	≥ 500

## Characteristics

Attenuation	≤ 0.3 dB
-------------	----------

## Environmental and real-life conditions

### Ambient conditions

Degree of protection	IP20 (according to IEC 60529) IP20
Ambient temperature (operation)	-40 °C ... 85 °C
Ambient temperature (storage/transport)	-40 °C ... 85 °C

# FOC-FDX20-PP-STD6-OSP-PT9 - Splice box



1019682

<https://www.phoenixcontact.com/us/products/1019682>

Ambient temperature (assembly)	0 °C ... 50 °C
Resistance to UV radiation	yes

## Standards and regulations

Resistance to UV radiation	yes
Flame resistance	yes

## Mounting

Mounting type	DIN rail mounting
Assembly instructions	Option for flexible replugging of DIN rail adapter
Connection method	Splicing

# FOC-FDX20-PP-STD6-OSP-PT9 - Splice box



1019682

<https://www.phoenixcontact.com/us/products/1019682>

## Drawings

Dimensional drawing

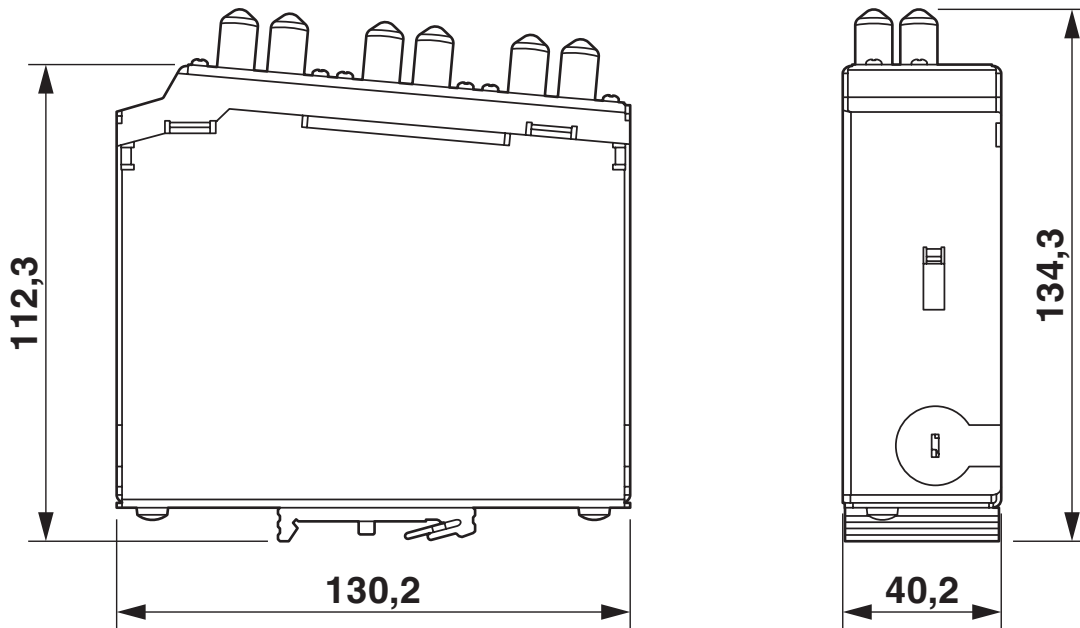

DIN rail splice box 6x ST duplex OS2, fully mounted ready to splice

# FOC-FDX20-PP-STD6-OSP-PT9 - Splice box



1019682

<https://www.phoenixcontact.com/us/products/1019682>

## Classifications

### ECLASS

ECLASS-11.0	19170113
ECLASS-12.0	19170113
ECLASS-13.0	19170113

### ETIM

ETIM 8.0	EC002699
----------	----------

### UNSPSC

UNSPSC 21.0	43223300
-------------	----------

# FOC-FDX20-PP-STD6-OSP-PT9 - Splice box



1019682

<https://www.phoenixcontact.com/us/products/1019682>

## Environmental product compliance

China RoHS	Environmentally friendly use period: unlimited = EFUP-e
	No hazardous substances above threshold values

# FOC-FDX20-PP-STD6-OSP-PT9 - Splice box



1019682

<https://www.phoenixcontact.com/us/products/1019682>

## Mandatory accessories

### FOC-SHRINKSPLICE-PROTECT - Shrink splice protection

1019676

<https://www.phoenixcontact.com/us/products/1019676>



Shrink splice protection, design: Straight, degree of protection: IP20, cable outlet: above and below, color: transparent

---

### FOC-CRIMPSPLICE-PROTECT - Crimp splice protection

1019678

<https://www.phoenixcontact.com/us/products/1019678>



Crimp splice protection, design: Straight, degree of protection: IP20, connection method: Crimp connection, cable outlet: above and below, color: Bare metallic

---

## Accessories



# FOC-FDX20-PP-STD6-OSP-PT9 - Splice box



1019682

<https://www.phoenixcontact.com/us/products/1019682>

## FOC-ST:PA-ST:PA-OS2:D01/1 - FO patch cable

1115565

<https://www.phoenixcontact.com/us/products/1115565>

Single-mode OS2 duplex jumper, ST-ST, UPC polishing, length 1 m

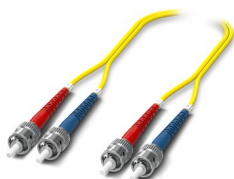

---

## FOC-ST:PA-SC:PA-OS2:D01/1 - FO patch cable

1115582

<https://www.phoenixcontact.com/us/products/1115582>

Single-mode OS2 duplex jumper, ST-SC, UPC polishing, length 1 m

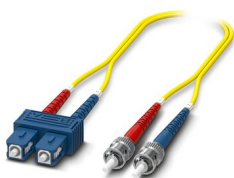

# FOC-FDX20-PP-STD6-OSP-PT9 - Splice box



1019682

<https://www.phoenixcontact.com/us/products/1019682>

## FOC-LC:PA-ST:PA-OS2:D01/1 - FO patch cable

1115596

<https://www.phoenixcontact.com/us/products/1115596>

Single-mode OS2 duplex jumper, LC-ST, UPC polishing, length 1 m

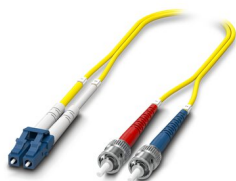

---

## FOC-ST:PA-ST:PA-OS2:D01/2 - FO patch cable

1115564

<https://www.phoenixcontact.com/us/products/1115564>

Single-mode OS2 duplex jumper, ST-ST, UPC polishing, length 2 m

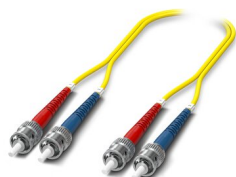

# FOC-FDX20-PP-STD6-OSP-PT9 - Splice box

1019682

<https://www.phoenixcontact.com/us/products/1019682>



## FOC-ST:PA-SC:PA-OS2:D01/2 - FO patch cable

1115581

<https://www.phoenixcontact.com/us/products/1115581>

Single-mode OS2 duplex jumper, ST-SC, UPC polishing, length 2 m

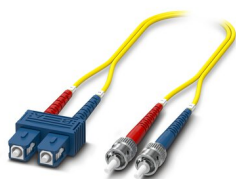

---

## FOC-LC:PA-ST:PA-OS2:D01/2 - FO patch cable

1115595

<https://www.phoenixcontact.com/us/products/1115595>

Single-mode OS2 duplex jumper, LC-ST, UPC polishing, length 2 m

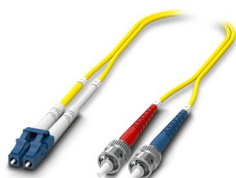

# FOC-FDX20-PP-STD6-OSP-PT9 - Splice box



1019682

<https://www.phoenixcontact.com/us/products/1019682>

## FOC-ST:PA-ST:PA-OS2:D01/5 - FO patch cable

1115562

<https://www.phoenixcontact.com/us/products/1115562>

Single-mode OS2 duplex jumper, ST-ST, UPC polishing, length 5 m

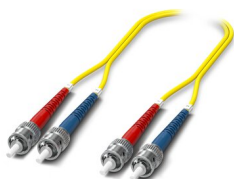

---

## FOC-ST:PA-SC:PA-OS2:D01/5 - FO patch cable

1115579

<https://www.phoenixcontact.com/us/products/1115579>

Single-mode OS2 duplex jumper, ST-SC, UPC polishing, length 5 m

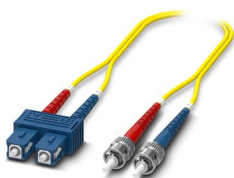

# FOC-FDX20-PP-STD6-OSP-PT9 - Splice box



1019682

<https://www.phoenixcontact.com/us/products/1019682>

## FOC-LC:PA-ST:PA-OS2:D01/5 - FO patch cable

1115592

<https://www.phoenixcontact.com/us/products/1115592>

Single-mode OS2 duplex jumper, LC-ST, UPC polishing, length 5 m

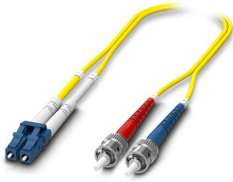

---

## FOC-OE-OE-GL-U-OS2-12/... - FO cable

1286219

<https://www.phoenixcontact.com/us/products/1286219>



GOF universal cable; 12-wire, loose tube cable for fixed installation; non-metal rodent protection; can be stripped easily; UV resistant; high mechanical and thermal stability; low smoke; halogen-free and self-extinguishing; improved impact resistance; longitudinally and transversely watertight

# FOC-FDX20-PP-STD6-OSP-PT9 - Splice box



1019682

<https://www.phoenixcontact.com/us/products/1019682>

## FOC-TOOL-FERRULECLEANER-2.50 - FO accessories

1407029

<https://www.phoenixcontact.com/us/products/1407029>

2.50 mm ferrule cleaner, for ST, SC, FC, E2000 (also APC), approx. 500 cleaning cycles



---

## FOC-TOOL-STICKCLEANER-2.50 - FO accessories

1407002

<https://www.phoenixcontact.com/us/products/1407002>

Stick cleaner for couplings and plug end faces, 2.50 mm (ST, SC), Pcs. / Pkt.: 10



# FOC-FDX20-PP-STD6-OSP-PT9 - Splice box



1019682

<https://www.phoenixcontact.com/us/products/1019682>

## A-INSP-M20-68N-P-LG - Screw plug

1424519

<https://www.phoenixcontact.com/us/products/1424519>

Screw plug, material for screw connection: PA, connecting thread: M20 x 1.5, color: lightgrey RAL 7035, with O-ring



---

## WP-CN PA M20 - Nut

3241134

<https://www.phoenixcontact.com/us/products/3241134>

Nut, for threads M20, color: gray



# FOC-FDX20-PP-STD6-OSP-PT9 - Splice box



1019682

<https://www.phoenixcontact.com/us/products/1019682>

## SF-PH 1-80 - Screwdriver

1212559

<https://www.phoenixcontact.com/us/products/1212559>



Screwdriver, PH crosshead (lasered), uninsulated, size: PH 1 x 80, 2-component grip, with non-slip grip

---

## SF-SL 1,0X5,5-150 - Screwdriver

1212552

<https://www.phoenixcontact.com/us/products/1212552>



Screwdriver, bladed (lasered), size: 1.0 x 5.5 x 150 mm, 2-component grip, with non-slip grip



# FOC-FDX20-PP-STD6-OSP-PT9 - Splice box



1019682

<https://www.phoenixcontact.com/us/products/1019682>

## E/NS 35 N - End clamp

0800886

<https://www.phoenixcontact.com/us/products/0800886>

End clamp, width: 9.5 mm, color: gray

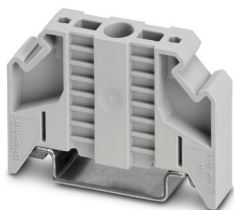

---

## NBC-PP-G1PGY - DIN rail adapter

1041740

<https://www.phoenixcontact.com/us/products/1041740>

DIN rail adapter, design: Headers with shielding, degree of protection: IP20, material: PC-GF10, connection method: Quick connection, without assembled modules



# FOC-FDX20-PP-STD6-OSP-PT9 - Splice box

1019682

<https://www.phoenixcontact.com/us/products/1019682>



## FL DIN RA - DIN rail adapter

2891053

<https://www.phoenixcontact.com/us/products/2891053>

The FL DIN RA is installed in a standard, 19-inch rack (EIA-310-D, IEC 60297-3-100) to allow DIN rail mounted equipment to be rack mounted.

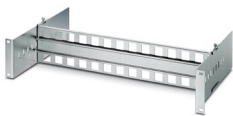

---

## G-INS-M20-S68N-PNES-GY - Cable gland

1411125

<https://www.phoenixcontact.com/us/products/1411125>

Cable gland, material for screw connection: PA, external cable diameter 6 mm ... 12 mm, shielding: no, connecting thread: M20 x 1.5, color: silver-grey RAL 7001



# FOC-FDX20-PP-STD6-OSP-PT9 - Splice box



1019682

<https://www.phoenixcontact.com/us/products/1019682>

## TML (104X10)R - Marker strip

0801835

<https://www.phoenixcontact.com/us/products/0801835>



Marker strip, Roll, white, unlabeled, can be labeled with: THERMOMARK E.300 (D)/600 (D), THERMOMARK ROLL 2.0, THERMOMARK ROLL, THERMOMARK ROLL X1, THERMOMARK ROLLMASTER 300/600, THERMOMARK X1.2, mounting type: adhesive, for terminal block width: 104 mm, lettering field size: 104 x 10 mm, Number of individual labels: 1500

---

## TML (EX9,5)R TR - Marker strip

0816634

<https://www.phoenixcontact.com/us/products/0816634>



Marker strip, Roll, transparent, unlabeled, can be labeled with: THERMOMARK E.300 (D)/600 (D), THERMOMARK ROLL 2.0, THERMOMARK ROLL, THERMOMARK ROLL X1, THERMOMARK ROLLMASTER 300/600, THERMOMARK X1.2, mounting type: adhesive, for terminal block width: 30000 mm, lettering field size: 40000 x 9.5 mm, Number of individual labels: 1

# FOC-FDX20-PP-STD6-OSP-PT9 - Splice box



1019682

<https://www.phoenixcontact.com/us/products/1019682>

## EMLS (70X32)R SR - Safety label with special adhesive

0800346

<https://www.phoenixcontact.com/us/products/0800346>



Safety label with special adhesive, Roll, silver, unlabeled, can be labeled with: THERMOMARK E.300 (D)/600 (D), THERMOMARK ROLL 2.0, THERMOMARK ROLL, THERMOMARK ROLL X1, THERMOMARK ROLLMASTER 300/600, THERMOMARK X1.2, mounting type: adhesive, lettering field size: 70 x 32 mm, Number of individual labels: 500

---

## EML-HA (76X51)R - Label for rough surfaces

0830609

<https://www.phoenixcontact.com/us/products/0830609>



Label for rough surfaces, Roll, white, unlabeled, can be labeled with: THERMOMARK E.300 (D)/600 (D), THERMOMARK ROLL 2.0, THERMOMARK ROLL, THERMOMARK ROLL X1, THERMOMARK ROLLMASTER 300/600, THERMOMARK X1.2, mounting type: adhesive, lettering field size: 76 x 51 mm, Number of individual labels: 1000

# FOC-FDX20-PP-STD6-OSP-PT9 - Splice box



1019682

<https://www.phoenixcontact.com/us/products/1019682>

## PML-W100 (25X25)R - Warning label

0830429

<https://www.phoenixcontact.com/us/products/0830429>



Warning label, Roll, yellow/black, unlabeled, can be labeled with: THERMOMARK E.300 (D)/600 (D), THERMOMARK ROLL 2.0, THERMOMARK ROLL, THERMOMARK ROLL X1, THERMOMARK ROLLMASTER 300/600, THERMOMARK X1.2, mounting type: adhesive, diameter: 0 mm, lettering field size: 25 x 25 mm, Number of individual labels: 500

---

## LS-EMLP (60X15) WH - Device marker

0831696

<https://www.phoenixcontact.com/us/products/0831696>



Device marker, Sheet, white, unlabeled, can be labeled with: TOPMARK NEO, TOPMARK LASER, mounting type: adhesive, lettering field size: 60 x 15 mm, Number of individual labels: 20

# FOC-FDX20-PP-STD6-OSP-PT9 - Splice box



1019682

<https://www.phoenixcontact.com/us/products/1019682>

## WML-RFID/HF 14 (25X19)R - Cable marker

0803386

<https://www.phoenixcontact.com/us/products/0803386>



Cable marker label with RFID-HF transponder, roll, white, unmarked, can be printed with: THERMOMARK ROLL, THERMOMARK ROLL X1, THERMOMARK X1.2, mounting type: adhesive, min. cable diameter: 9 mm, max. cable diameter: 14 mm, lettering field size: 25 x 19 mm

---

Phoenix Contact 2023 © - all rights reserved

<https://www.phoenixcontact.com>

Phoenix Contact USA

586 Fulling Mill Road

Middletown, PA 17057, United States

(+717) 944-1300

[info@phoenixcon.com](mailto:info@phoenixcon.com)