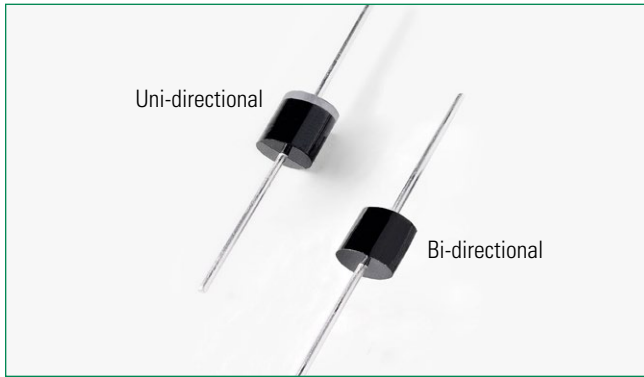


**20KPA Series**



**Agency Approvals**

Agency	Agency File Number
	E230531

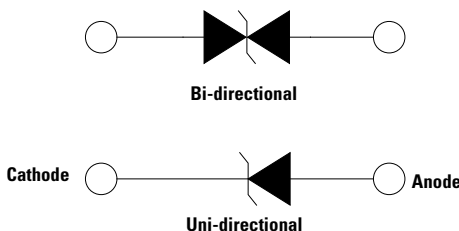
**Maximum Ratings and Thermal Characteristics**  
(T<sub>A</sub>=25°C unless otherwise noted)

Parameter	Symbol	Value	Unit
Peak Pulse Power Dissipation by 10/1000µs Test Waveform (Fig.2)(Note 1)	P <sub>PPM</sub>	20	kW
Steady State Power Dissipation on Infinite Heat Sink at T <sub>L</sub> =75°C	P <sub>D</sub>	8.0	W
Peak Forward Surge Current, 8.3ms Single Half Sine Wave Unidirectional Only (Note 2)	I <sub>FSM</sub>	400	A
Operating Junction and Storage Temperature Range	T <sub>J</sub> , T <sub>STG</sub>	-55 to 175	°C
Typical Thermal Resistance Junction to Lead	R <sub>θJL</sub>	8.0	°C/W
Typical Thermal Resistance Junction to Ambient	R <sub>θJA</sub>	40	°C/W

**Notes:**

1. Non-repetitive current pulse, per Fig. 4 and derated above T<sub>J</sub> (initial) =25°C per Fig. 3.
2. Measured on 8.3ms single half sine wave or equivalent square wave, duty cycle=4 per minute maximum.

**Functional Diagram**



**Descriptions**

The 20KPA Series is designed specifically to protect sensitive electronic equipment from voltage transients induced by lightning and other transient voltage events.

**Features**

- 20kW peak pulse capability at 10/1000µs waveform, repetition rate (duty cycles):0.01%
- Glass passivated chip junction in P600 package
- Fast response time: typically less than 1.0ps from 0 Volts to BV min
- Excellent clamping capability
- Typical failure mode is short from over-specified voltage or current
- Whisker test is conducted based on JEDEC JESD201A per its table 4a and 4c
- IEC-61000-4-2 ESD 30kV(Air), 30kV (Contact)
- ESD protection of data lines in accordance with IEC 61000-4-2
- EFT protection of data lines in accordance with IEC 61000-4-4
- Low incremental surge resistance
- Typical I<sub>R</sub> less than 2µA when V<sub>BR</sub> min>49V
- High temperature to reflow soldering guaranteed: 260°C/40sec / 0.375", (9.5mm) lead length, 5 lbs., (2.3kg) tension
- V<sub>BR</sub> @ T<sub>J</sub>= V<sub>BR</sub> @25°C x (1+ α T x (T<sub>J</sub> - 25)) (α T:Temperature Coefficient, typical value is 0.1%)
- UL Recognized compound meeting flammability rating V-0
- Matte tin lead-free plated
- Halogen free and RoHS compliant
- Pb-free E3 means 2nd level interconnect is Pb-free and the terminal finish material is tin(Sn) (IPC/ JEDEC J-STD-609A.01)

**Applications**

TVS components are ideal for the protection of I/O interfaces, V<sub>CC</sub> bus and other vulnerable circuits used in telecom, computer, industrial and consumer electronic applications.

**Additional Information**



**Datasheet**




**Resources**



**Samples**

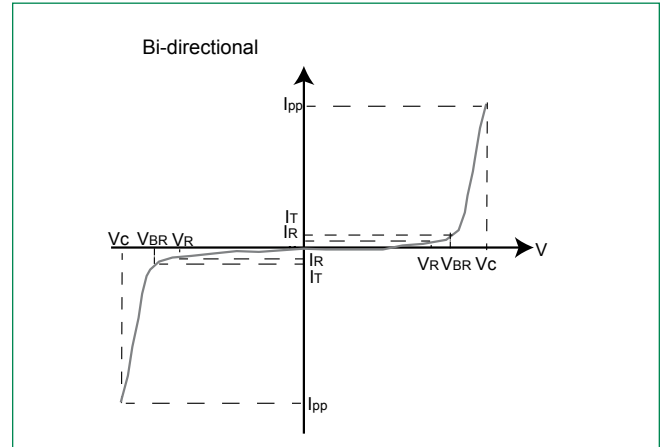
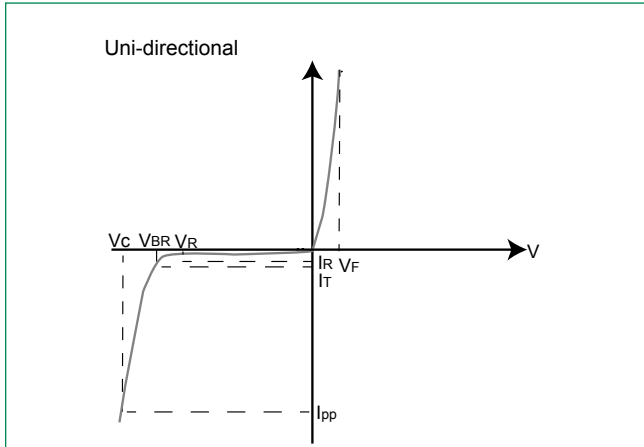
### Electrical Characteristics (T<sub>A</sub>=25°C unless otherwise noted)

Part Number (Uni)	Part Number (Bi)	Reverse Stand off Voltage V <sub>R</sub> (Volts)	Breakdown Voltage V <sub>BR</sub> (Volts) @ I <sub>T</sub>		Test Current I <sub>T</sub> (mA)	Maximum Peak Pulse Current I <sub>PP</sub> (A)	Maximum Reverse Leakage I <sub>R</sub> @ V <sub>R</sub> (μA)	Maximum Clamping Voltage V <sub>C</sub> @ I <sub>PP</sub> (V)	Agency Recognition 
			Min.	Max.					
20KPA20A	20KPA20CA	20	22.34	24.57	50	548.9	5000	36.8	X
20KPA24A	20KPA24CA	24	26.81	29.49	50	490.3	5000	41.2	X
20KPA26A	20KPA26CA	26	29.04	31.94	50	451.9	2000	44.7	X
20KPA28A	20KPA28CA	28	31.28	34.41	50	420.8	1000	48.0	X
20KPA30A	20KPA30CA	30	33.51	36.86	5	392.2	250	51.5	X
20KPA32A	20KPA32CA	32	35.74	39.31	5	372.0	150	54.3	X
20KPA34A	20KPA34CA	34	38.00	41.80	5	351.3	50	57.5	X
20KPA36A	20KPA36CA	36	40.20	44.22	5	328.5	20	61.5	X
20KPA40A	20KPA40CA	40	44.70	49.17	5	297.9	15	67.8	X
20KPA44A	20KPA44CA	44	49.10	54.01	5	277.9	2	72.7	X
20KPA48A	20KPA48CA	48	53.60	58.96	5	254.4	2	79.4	X
20KPA52A	20KPA52CA	52	58.10	63.91	5	235.4	2	85.8	X
20KPA56A	20KPA56CA	56	62.60	68.86	5	218.1	2	92.6	X
20KPA60A	20KPA60CA	60	67.00	73.70	5	207.0	2	97.6	X
20KPA64A	20KPA64CA	64	71.50	78.65	5	194.2	2	104.0	X
20KPA68A	20KPA68CA	68	76.00	83.60	5	183.6	2	110.0	X
20KPA72A	20KPA72CA	72	80.40	88.44	5	174.1	2	116.0	X
20KPA80A	20KPA80CA	80	89.40	98.34	5	155.4	2	130.0	X
20KPA88A	20KPA88CA	88	98.30	108.13	5	142.3	2	142.0	X
20KPA96A	20KPA96CA	96	107.20	117.92	5	130.3	2	155.0	X
20KPA104A	20KPA104CA	104	116.20	127.82	5	120.2	2	168.0	X
20KPA112A	20KPA112CA	112	125.10	137.61	5	111.0	2	182.0	X
20KPA120A	20KPA120CA	120	134.00	147.40	5	104.1	2	194.0	X
20KPA132A	20KPA132CA	132	147.40	162.14	5	94.8	2	213.0	X
20KPA144A	20KPA144CA	144	160.80	176.88	5	87.1	2	232.0	X
20KPA160A	20KPA160CA	160	178.70	196.57	5	78.3	2	258.0	X
20KPA172A	20KPA172CA	172	192.10	211.31	5	72.9	2	277.0	X
20KPA180A	20KPA180CA	180	201.10	221.21	5	69.4	2	291.0	X
20KPA192A	20KPA192CA	192	214.50	235.95	5	65.4	2	309.0	X
20KPA204A	20KPA204CA	204	227.90	250.69	5	61.4	2	329.0	X
20KPA216A	20KPA216CA	216	241.30	265.43	5	58.0	2	348.0	X
20KPA232A	20KPA232CA	232	259.10	285.01	5	54.0	2	374.0	X
20KPA240A	20KPA240CA	240	268.10	294.91	5	52.2	2	387.0	X
20KPA256A	20KPA256CA	256	286.00	314.60	5	49.0	2	412.0	X
20KPA280A	20KPA280CA	280	312.80	344.08	5	44.8	2	451.0	X
20KPA300A	20KPA300CA	300	335.10	368.61	5	41.8	2	483.0	X

For bidirectional type having V<sub>RWM</sub> of 40 volts and less, the I<sub>T</sub> limit is double.

For parts without A, the V<sub>BR</sub> is ± 10% and V<sub>C</sub> is 5% higher than with A parts, the parts without A are currently available, but not recommended for new designs. The parts with A are preferred.

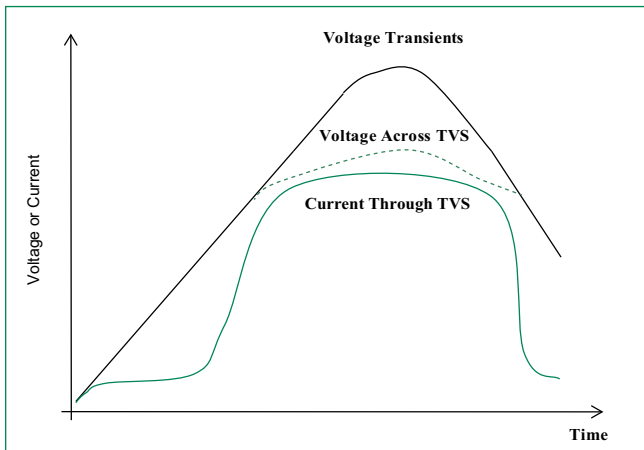
**I-V Curve Characteristics**



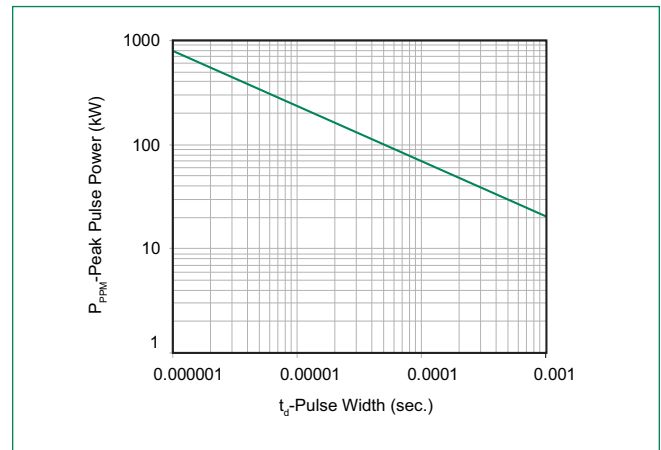
- $P_{PPM}$  Peak Pulse Power Dissipation** – Max power dissipation
- $V_R$  Stand-off Voltage** – Maximum voltage that can be applied to the TVS without operation
- $V_{BR}$  Breakdown Voltage** – Maximum voltage that flows through the TVS at a specified test current ( $I_T$ )
- $V_C$  Clamping Voltage** – Peak voltage measured across the TVS at a specified  $I_{ppm}$  (peak impulse current)
- $I_R$  Reverse Leakage Current** – Current measured at  $V_R$
- $V_F$  Forward Voltage Drop for Uni-directional**

**Ratings and Characteristic Curves** ( $T_A=25^\circ\text{C}$  unless otherwise noted)

**Figure 1 - TVS Transients Clamping Waveform**

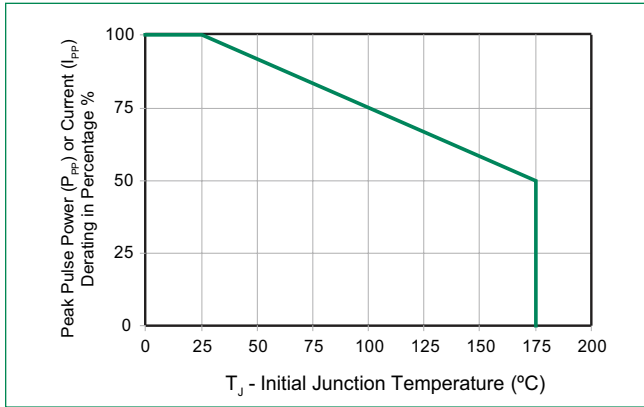


**Figure 2 - Peak Pulse Power Rating Curve**

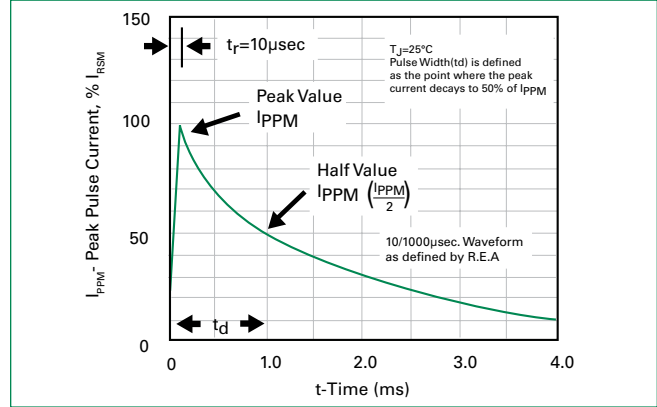


**Ratings and Characteristic Curves** ( $T_A=25^\circ\text{C}$  unless otherwise noted) (Continued)

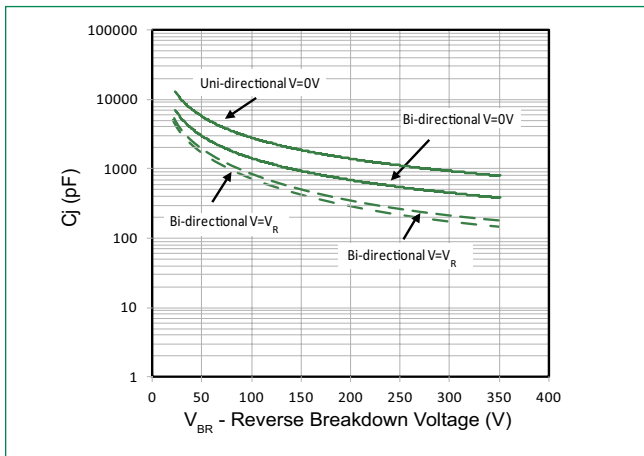
**Figure 3 - Peak Pulse Power Derating Curve**



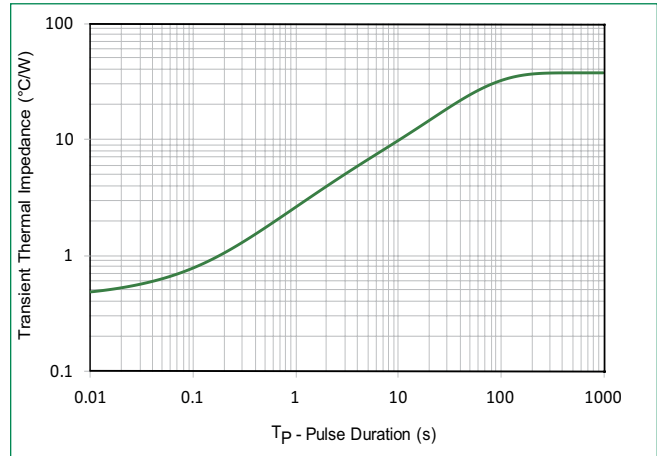
**Figure 4 - Pulse Waveform**



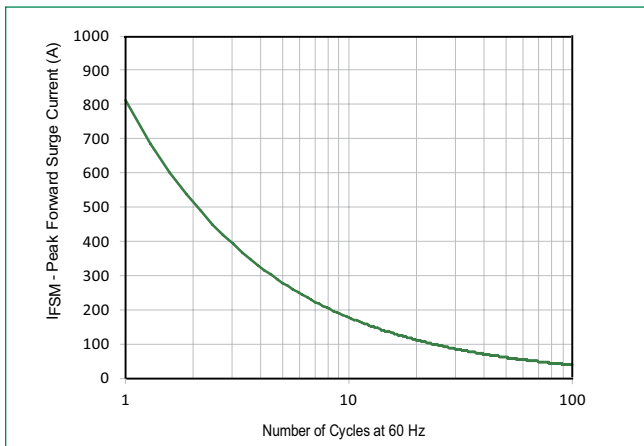
**Figure 5 - Typical Junction Capacitance**



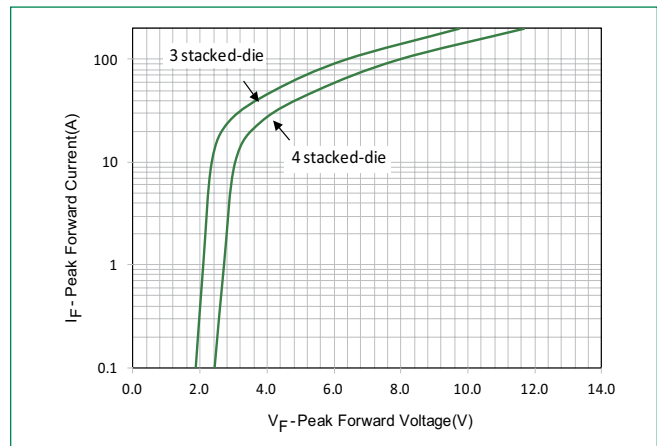
**Figure 6 - Typical Transient Thermal Impedance**



**Figure 7 - Maximum Non-Repetitive Peak Forward Surge Current Uni-Directional Only**

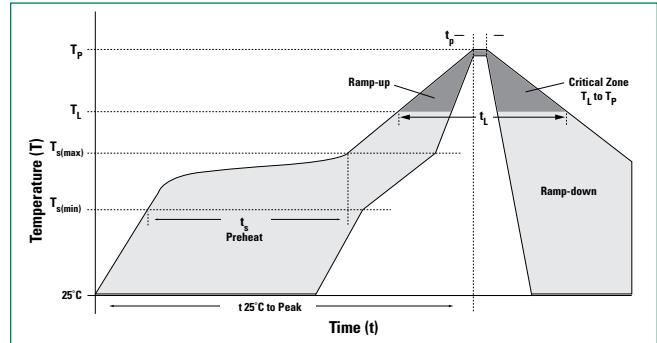


**Figure 8 - Peak Forward Voltage Drop vs Peak Forward Current (Typical Values)**



**Soldering Parameter**

<b>Reflow Condition</b>		Lead-free assembly
<b>Pre Heat</b>	- Temperature Min ( $T_{s(min)}$ )	150°C
	- Temperature Max ( $T_{s(max)}$ )	200°C
	- Time (min to max) ( $t_s$ )	60 – 180 secs
<b>Average ramp up rate (Liquidus Temp (<math>T_A</math>) to peak)</b>		3°C/second max
<b><math>T_{s(max)}</math> to <math>T_A</math> - Ramp-up Rate</b>		3°C/second max
<b>Reflow</b>	- Temperature ( $T_A$ ) (Liquidus)	217°C
	- Time (min to max) ( $t_s$ )	60 – 150 seconds
<b>Peak Temperature (<math>T_p</math>)</b>		260 <sup>+0/-5</sup> °C
<b>Time within 5°C of actual peak Temperature (<math>t_p</math>)</b>		20 – 40 seconds
<b>Ramp-down Rate</b>		6°C/second max
<b>Time 25°C to peak Temperature (<math>T_p</math>)</b>		8 minutes Max.
<b>Do not exceed</b>		210°C



**Flow/Wave Soldering (Solder Dipping)**

<b>Peak Temperature :</b>	265°C
<b>Dipping Time :</b>	10 seconds
<b>Soldering :</b>	1 time

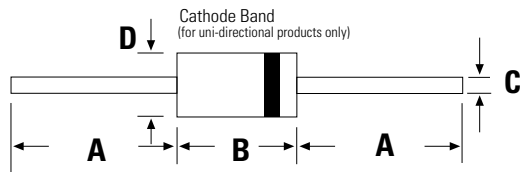
**Physical Specifications**

<b>Weight</b>	0.07oz., 2.5g
<b>Case</b>	P600 molded plastic body over passivated junction.
<b>Polarity</b>	Color band denotes the cathode except Bipolar.
<b>Terminal</b>	Matte Tin axial leads, solderable per JESD22-B102.

**Environmental Specifications**

<b>High Temp. Storage</b>	JESD22-A103
<b>HTRB</b>	JESD22-A108
<b>Temperature Cycling</b>	JESD22-A104
<b>H3TRB</b>	JESD22-A101
<b>RSH</b>	JESD22-B106

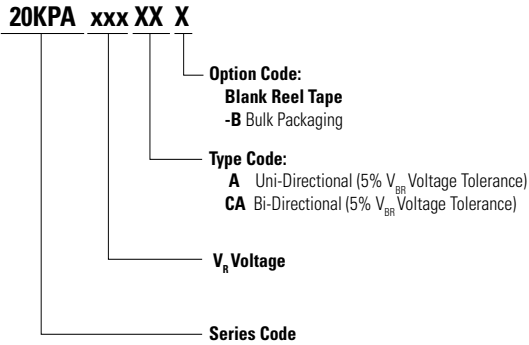
**Dimensions**



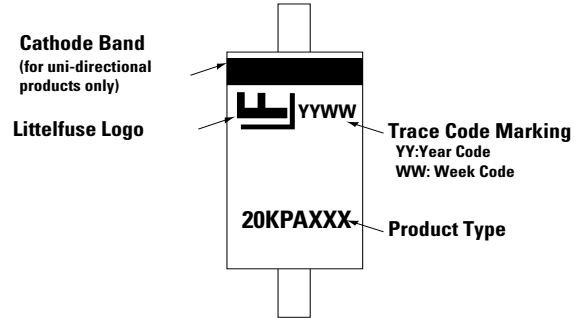
**P600**

Dimensions	Inches		Millimeters	
	Min	Max	Min	Max
<b>A</b>	1.000	-	25.40	-
<b>B</b>	0.340	0.360	8.60	9.10
<b>C</b>	0.048	0.054	1.22	1.36
<b>D</b>	0.340	0.360	8.60	9.10

### Part Numbering System



### Part Marking System



### Packing Options

Part Number	Component Package	Quantity	Packaging Option	Packaging Specification
20KPAxxxXX	P600	800	Tape & Reel	EIA STD RS-296
20KPAxxxXX-B	P600	100	Bulk	Littelfuse Spec.

### Tape and Reel Specification

