

Type 0AKM

Electric Vehicle Auxiliary Fuses

0AKM Series

RoHS Compliant

Description

500VDC rated ceramic tube fuse

Features



- Design to EV fuse standard UL248-20
- Reliability performance design refer to ISO8820-8&GB/T31465.6
- Excellent DC performance
- Full compliance with EU Directive 2011/65/EU and amending directive 2015/863

Applications

EV/HEV/ESS Applications

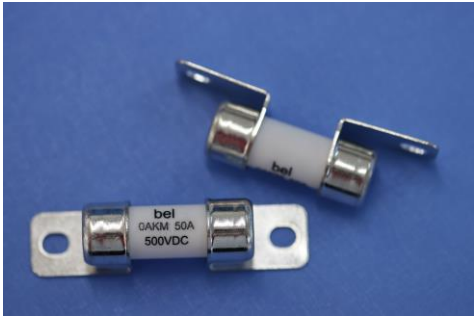
Physical Specifications



Materials	Body : Ceramic
	Terminals : Tin Plated Copper
Marking	On Fuse :
	"bel", "0AKM"
	"Current Rating", "Voltage Rating"
	On Label :
	"bel", "0AKMX", "Current Rating", "Voltage Rating", "Interrupting Rating", and "  ", "  "(China RoHS compliant).

Ratings

Ampere Rating / Voltage Rating	Ampere Range / Volt @ I.R. ability*
50A-80A / 500V DC 420V AC	50A-80A / 500V @ 20kA DC 420V @ 6KA AC
*I.R.= Interrupting Rating = Short Circuit Rating(Amps)	



bel POWER SOLUTIONS & PROTECTION
a bel group

Specifications subject to change without notice

belfuse.com/circuit-protection

Temperature Derating Curve

Operating Temperature: -40°C to +125°C,
with proper derating factor applied

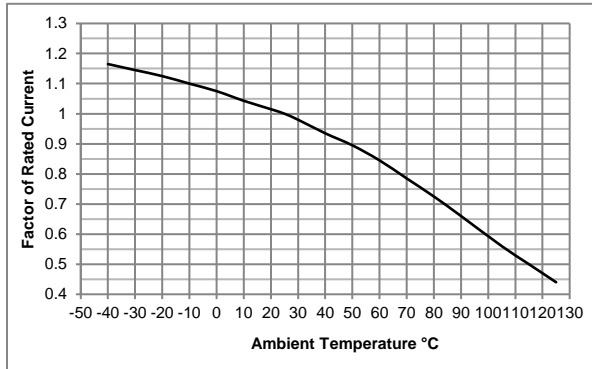

Average Time Current Curve

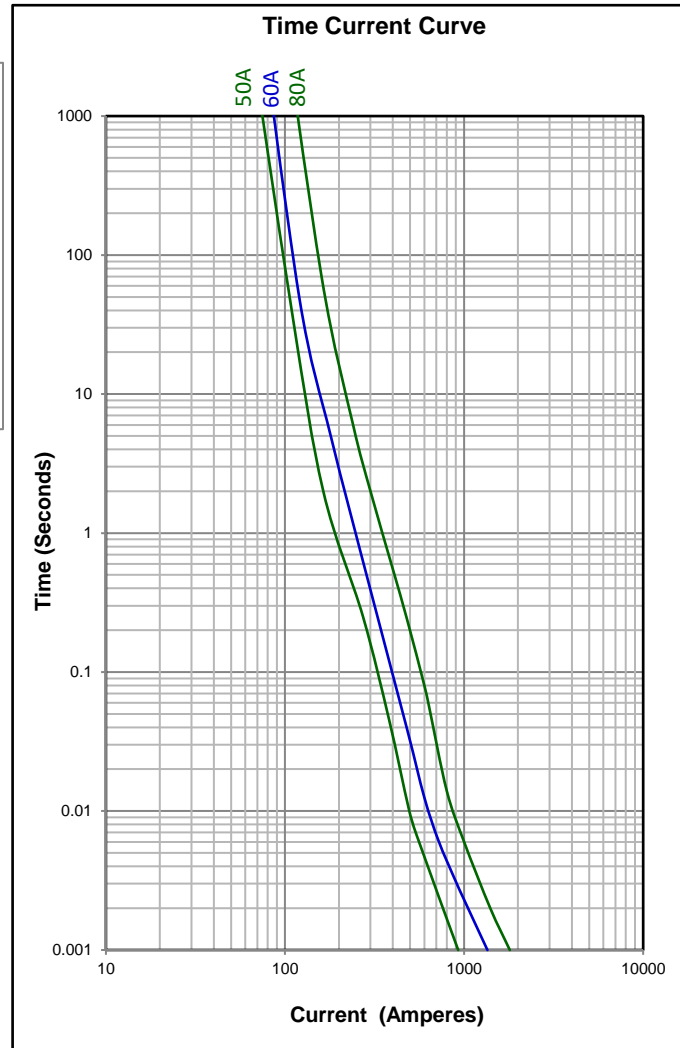

Electrical Specifications

Part Number	Rated Current	Voltage and Interrupting Ratings	I ² t *	Power Loss@0.5I _n (W)
			(A ² sec) Pre-arcing	
0AKMx9500-xx	50A	See Table of Ratings on Page 1 for Voltage and associated Interrupting Ratings	1760	1.35
0AKMx9600-xx	60A		3960	1.70
0AKMx9800-xx	80A		8020	1.90

Consult manufacturer for other ratings
* I²t is measured with 10I_n.



Specifications subject to change without notice

Bel Fuse Inc.
206 Van Vorst Street
Jersey City, NJ 07302 USA

+1 201.432.0463
Bel.US.CS@belf.com
belfuse.com/circuit-protection

Type 0AKM

Fuse FGNO Explanation

0AKM X [XXXX] -XX

0AKMB=0AKMB; [XXXX]=Ampere Rating; XX=See Ordering Information as below

Amps	Bel FGNO[XXXX]
50A	9500
60A	9600
80A	9800

Mechanical Dimensions

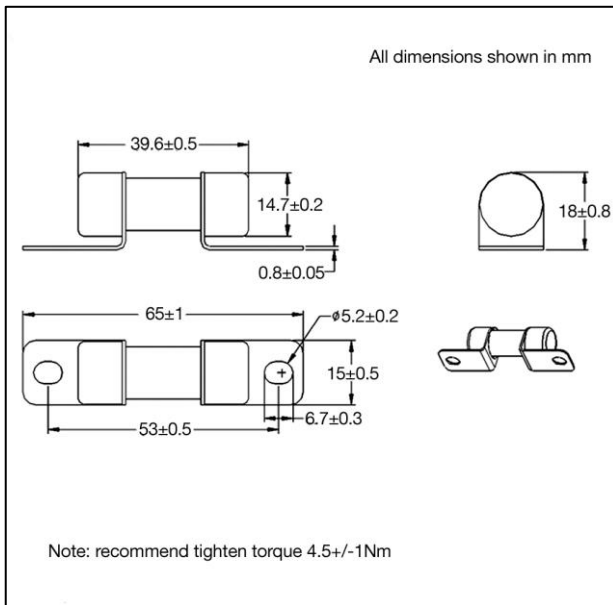

Ordering Information

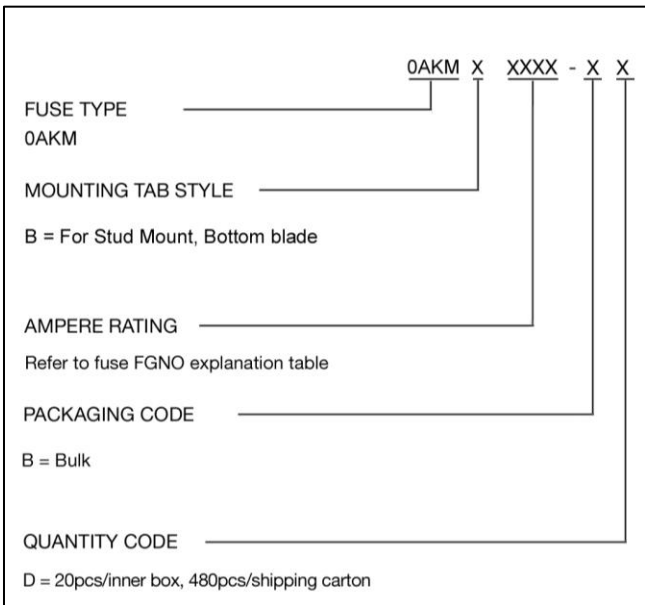

Packaging

Packaging Option	Quantity	Packaging Code
Bulk	20pcs/inner box, 480pcs/shipping carton	BD



Specifications subject to change without notice

Bel Fuse Inc.
206 Van Vorst Street
Jersey City, NJ 07302 USA

+1 201.432.0463
Bel.US.CS@belf.com
belfuse.com/circuit-protection