

Features

- 75 Ohm
- SMT unit
- RoHS Compliant and Pb free.

Description

MAFL-011055 is a Low Cost, surface mount Diplex Filter unit designed for CATV applications, DTV and DBS applications.

Functional Schematic

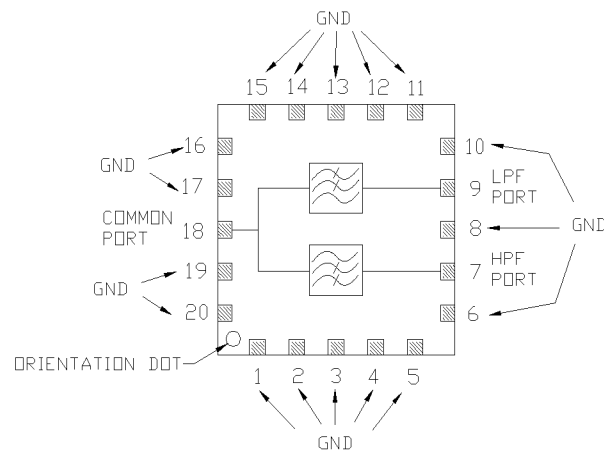

Ordering Information

| Part Number | Package |
|-------------|---------|
| MAFL-011055 | 200 |

Pin Configuration

| Function | Pin Number |
|----------------|-------------------------|
| Common Port | 18 |
| Low Pass Port | 9 |
| High Pass Port | 7 |
| Ground | 1 - 6, 8, 10-17, 19, 20 |
| Not connected | - |

Electrical Specifications: $T_A = 25^\circ\text{C}$, $Z_0 =$

| Parameter | Units | Min | Typ | Max |
|---|---------------|------|-----|-----|
| Insertion Loss 5 - 42 MHz | dB | - | 0.5 | 1.3 |
| | 54 - 1218 MHz | dB | 0.5 | 1.3 |
| Insertion Loss Flatness 5 - 42 MHz | dB | - | - | 0.5 |
| Filter Rejection 5 - 42 MHz | dB | 43 | 50 | - |
| | 54 - 1218 MHz | dB | 43 | 50 |
| Filter Return Loss (all ports) 5 - 42 MHz | dB | 18 | 20 | - |
| | 54 - 1218 MHz | dB | 17 | 19 |
| Group Delay 38.5 - 42 MHz | nSec | - | - | 20 |
| | 54 - 57.5 MHz | nSec | - | 20 |

Recommended Maximum Ratings

| Parameter | Value |
|-----------------------|----------------|
| Storage Temperature | -40°C to +85°C |
| Operating Temperature | -40°C to +85°C |
| DC Current | 30mA |
| RF Power | 250mW |

Outline Drawing

TOP VIEW

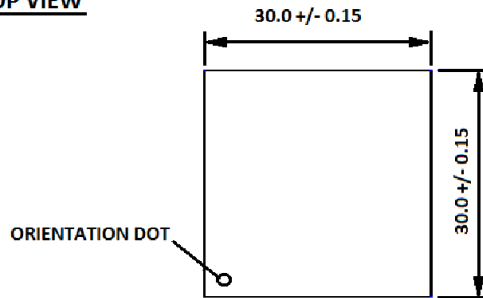

SIDE VIEW

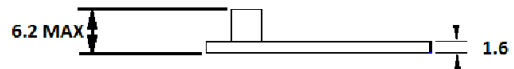

PCB TOP VIEW

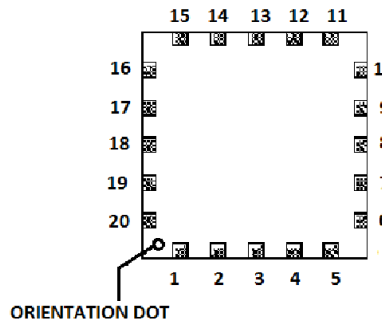

PCB BOTTOM VIEW

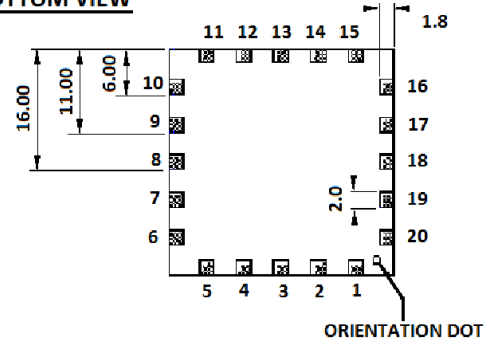

Dimensions in mm. Tolerance: .x ± 0.1, .xx ± 0.05

Recommended PCB Configuration

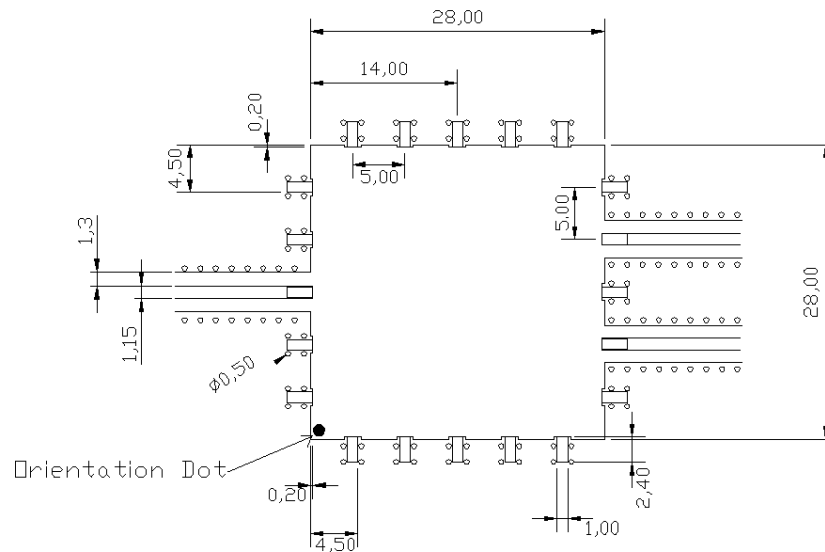

Dimensions in mm. Tolerance: .x ± 0.1, .xx ± 0.05

CATV Diplex Filter 5-42 / 54-1218MHz

Rev. V2

Typical Performance: $T_A = 25^\circ\text{C}$, $Z_0 = 75\Omega$

Input Port Return Loss

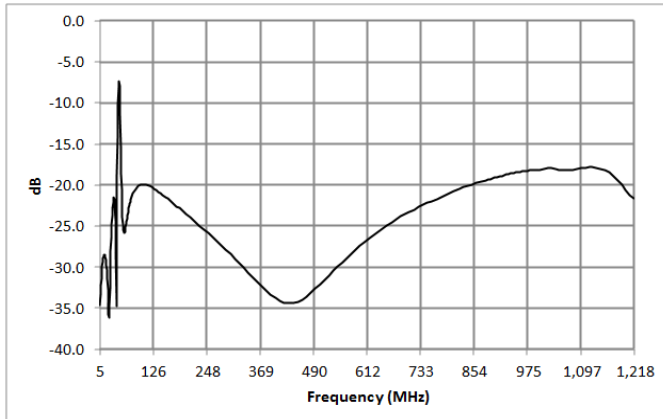

Low Pass Filter Insertion Loss

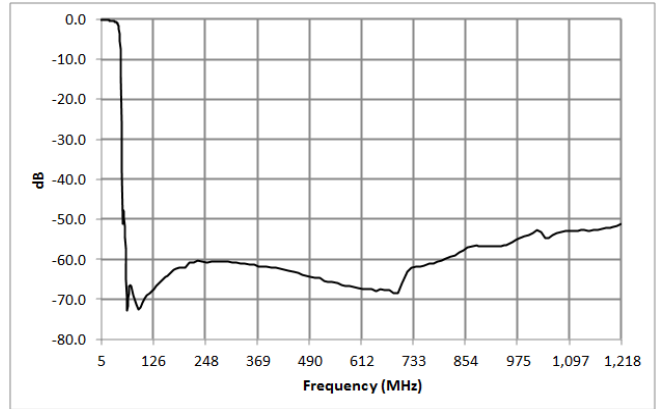

High Pass Filter Insertion Loss

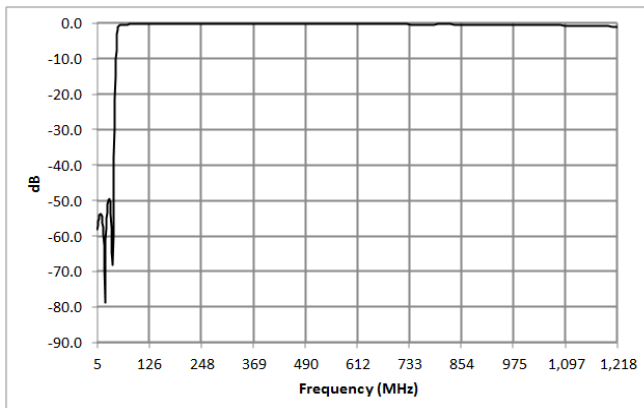

Filter Isolation

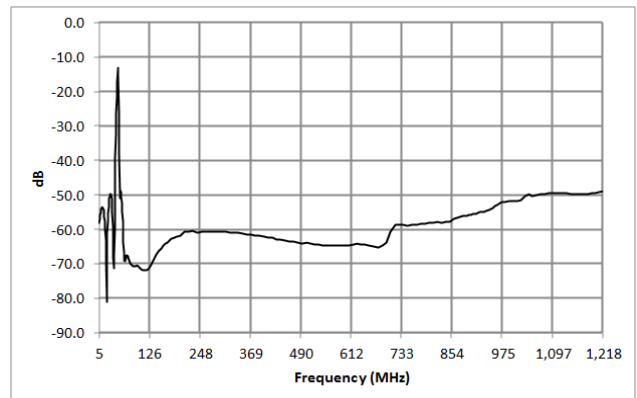

Low Pass port Return Loss

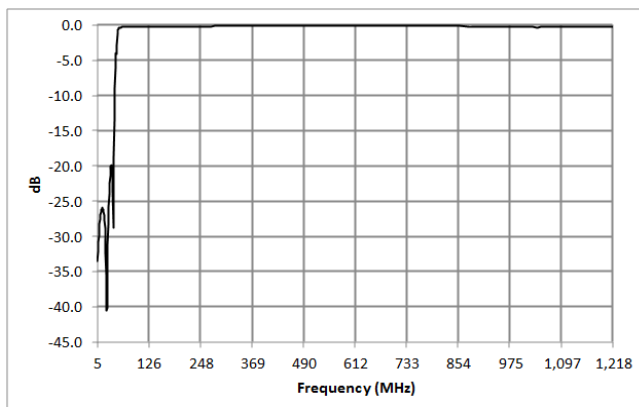

High Pass port Return Loss

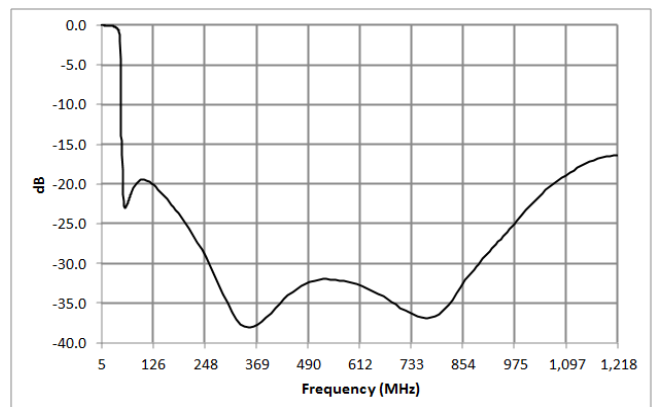

Tape & Reel Information

| Parameter | Units | Value |
|--|-------|-------|
| Qty per reel | - | 200 |
| Reel Size | mm | 330 |
| Tape Width | mm | 56.00 |
| Pitch | mm | 40.00 |
| Ao | mm | 30.3 |
| Bo | mm | 30.3 |
| Ko | mm | 6.4 |
| Orientation | - | F30 |
| Reference Application Note ANI-019 for orientation | | |

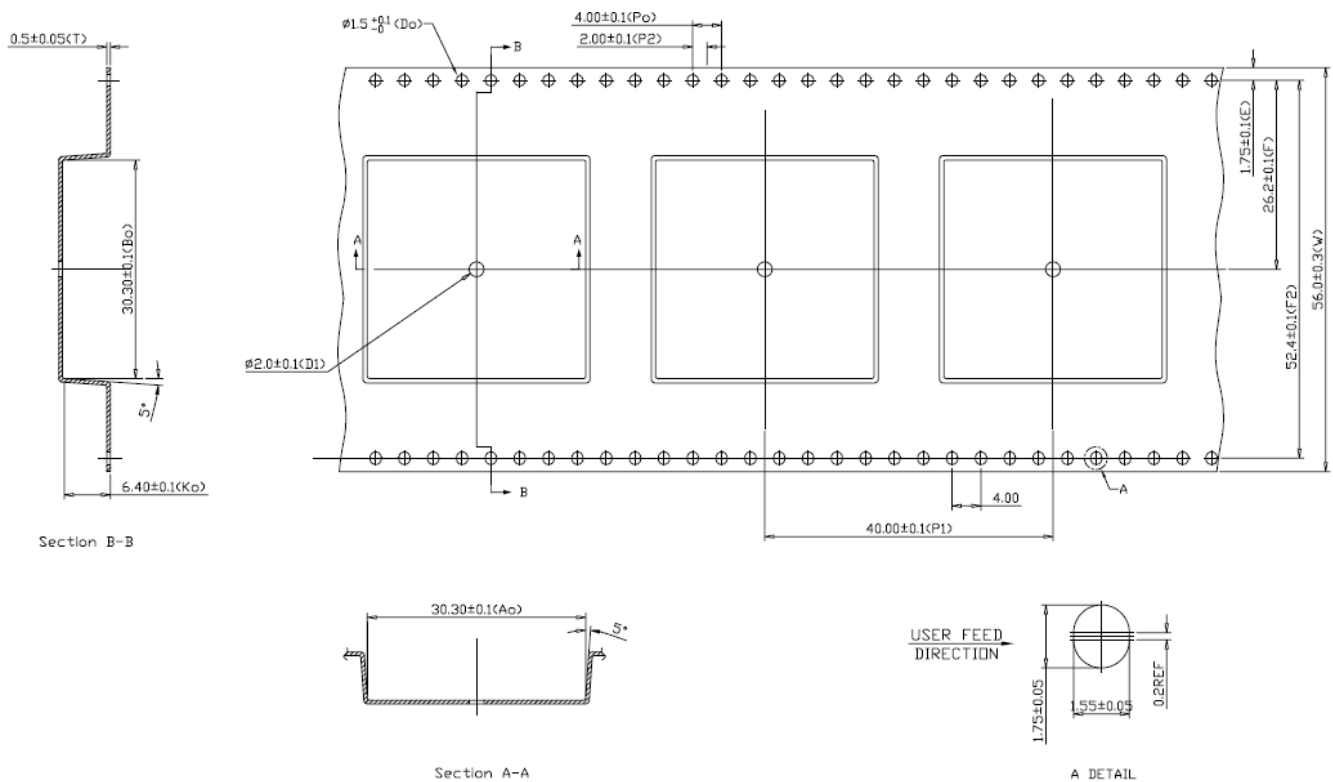

M/A-COM Technology Solutions Inc. All rights reserved.

Information in this document is provided in connection with M/A-COM Technology Solutions Inc ("MACOM") products. These materials are provided by MACOM as a service to its customers and may be used for informational purposes only. Except as provided in MACOM's Terms and Conditions of Sale for such products or in any separate agreement related to this document, MACOM assumes no liability whatsoever. MACOM assumes no responsibility for errors or omissions in these materials. MACOM may make changes to specifications and product descriptions at any time, without notice. MACOM makes no commitment to update the information and shall have no responsibility whatsoever for conflicts or incompatibilities arising from future changes to its specifications and product descriptions. No license, express or implied, by estoppels or otherwise, to any intellectual property rights is granted by this document.

THESE MATERIALS ARE PROVIDED "AS IS" WITHOUT WARRANTY OF ANY KIND, EITHER EXPRESS OR IMPLIED, RELATING TO SALE AND/OR USE OF MACOM PRODUCTS INCLUDING LIABILITY OR WARRANTIES RELATING TO FITNESS FOR A PARTICULAR PURPOSE, CONSEQUENTIAL OR INCIDENTAL DAMAGES, MERCHANTABILITY, OR INFRINGEMENT OF ANY PATENT, COPYRIGHT OR OTHER INTELLECTUAL PROPERTY RIGHT. MACOM FURTHER DOES NOT WARRANT THE ACCURACY OR COMPLETENESS OF THE INFORMATION, TEXT, GRAPHICS OR OTHER ITEMS CONTAINED WITHIN THESE MATERIALS. MACOM SHALL NOT BE LIABLE FOR ANY SPECIAL, INDIRECT, INCIDENTAL, OR CONSEQUENTIAL DAMAGES, INCLUDING WITHOUT LIMITATION, LOST REVENUES OR LOST PROFITS, WHICH MAY RESULT FROM THE USE OF THESE MATERIALS.

MACOM products are not intended for use in medical, lifesaving or life sustaining applications. MACOM customers using or selling MACOM products for use in such applications do so at their own risk and agree to fully indemnify MACOM for any damages resulting from such improper use or sale.